





ORIGINAL *Küblerit*®
since 1863







Das Profil-Buch The Profile Book



Symbole / Symbols

Ta	für Tapeten for wallpaper	R13	R9-R13 / DIN 51130 Bewertungsgruppe Rutschsicherheit Value slip resistance
Ce	für Keramik for ceramic	V8	V4-V10 / DIN 51130 Bewertungsgruppe Verdrängungsraum Value displacement space
Vi	für LVT-Designbeläge und elastische Böden for LVT floors and elastic floors		zum Schrauben to screw
Te	für Teppichböden for carpet floors		zum Clippen to clip
Ha	für Hartböden for hard floor coverings		selbstklebend self-adhesive
			einfach biegsam easy bendable

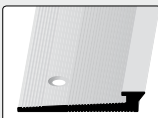
Produktversionen / product versions

	U ungebohrt, ungestanzt undrilled, unpunched		M mittig versenkt gebohrt centrally countersunk drilled
	S seitlich versenkt gebohrt laterally countersunk drilled		V versenkt gebohrt countersunk drilled
	G geschlossene „Doppel-K“ Stanzung closed „Double-K“ punched		EB einfach biegsame Stanzung easy bendable punched
	SK selbstklebend self-adhesive		



- A** Normalverschraubung bei Sicherheits-Treppenkantenprofilen / Standard drilling for Safty Stair Nosings
- C** Doppelschraubung bei Sicherheits-Treppenkantenprofilen / Double drilling for Safty Stair Nosings
- SB** Selbstbedienungsverpackung / Prepacked articles for self-service

- GE** Gleitschutzeinlage / Slip-resistant insert
- GS** Gleitschutzeinlage mit PVC / Slip-resistant with PVC insert
- GM** Gleitschutzeinlage mit Mineralkörnung / Slip-resistant mineral insert

- N** neue Profil Version / new profile version
- SD** Schwerlast-Dehnfugenprofil / Heavy weight expansion joint profile
- SI** mit Silikon / with Silicone
- D** mit Dichtlippe / with Sealing lip
- H** Holzdekor / Wood Decor
- L** für Laminat Böden / for laminate floors
- T** mit Teppichkralle / with carpet claws
- WS** Wasserstrahlgeschnitten / Water jet cut
- IW** Innenwinkel / Internal Angle

- EC** vorgefertigtes Eckelement / prefabricated corner element
- EV** vorgefertigtes Eckelement mit Verbinder / prefabricated corner element with connector
- FK** vorgefertigtes Fugenkreuz / prefabricated cross profile
- IE** vorgefertigte Innenecke / prefabricated internal corner
- AE** vorgefertigte Außenecke / prefabricated external corner

- ◄► Angabe der Abdeckbreite für die Dehnungsfuge / Specification of the cover width for the expansion joint
- ↕ Bodenbelagshöhen / Flooring thicknesses



ORIGINAL **Küberit**®
since 1863

Küberit Profile Systems GmbH & Co. KG
Römerweg 9 • 58513 Lüdenscheid • Germany

Tel.: +49 2351 9507 0
Fax: +49 2351 9507 49
Fax Export: +49 2351 9507 200

www.kueberit.com
kueberit@kueberit.com • export@kueberit.com



Profile für textile, elastische und LVT-Designbeläge

Profiles for carpet, resilient flooring and LVT coverings

Ce

Vi

Te

Ha



Ta

Übergangsprofile und Wölbschienen
Connecting profiles and cover strips

7

Anpassungs-, Abschluss-, Einfass- und Rampenprofile
Adapting profiles, edge trims and ramp profiles

17

Treppenkanten- und Winkelprofile
Stair nosings and angle edges

37

Treppenläuferstangen, Heizrohrrosetten und Türstopper
Stairrods, heating pipe collars and door stoppers

65

Einfach biegbare EB- und Doppel-K Profile, Dehnfugenprofile
Easy bendable EB and perforated edge trims, expansion joint profiles

69

Wand-, Tapetenprofile und Eckschutzwinkel
Wall covering profiles and corner guards

87

Aluminium-Sockelleisten »Deco Base Board«
Aluminium skirtings »Deco Base-Board«

95

PPS®-Champion Star ⇅ 4 – 9,5 mm
2-teilig · Schraubsystem für LVT-Designbeläge oder Teppichböden
2-part · Screw system for LVT floors or carpet floors

103

Design-Clip® ⇅ 4 – 7,5 mm · **Design-Clip® XL** ⇅ 3,5 – 6,5 mm
2-teilig · Clipsystem für LVT-Designbeläge oder Teppichböden
2-part · Clip system for LVT floors or carpet floors

109

PPS®-Champion flex ⇅ 7 – 17 mm
3-teilig · Schraubsystem mit Verschiebenut und flex-Gelenk
3-part · Screw system with shifting grooves and flex joint

115

PPS®-Champion · PPS®-Champion smart · PPS®-Champion SK ⇅ 6,5 – 16 mm
2-teilig · Schraubsystem mit Verschiebenut
2-part · Screw system with shifting grooves

121

PPS®-Champion XXL ⇅ 7 – 18 mm · **PPS®-Champion XXL S** ⇅ 18 – 29 mm
2-teilig · XXL Schraubsystem mit Verschiebenut
2-part · XXL Screw system with shifting grooves

127

PPS®-Allrounder ⇅ 7 – 15 mm
2-teilig · Schraubsystem
2-part · Screw system

131

PPS®-AS ⇅ 5 – 11,5 mm
2-teilig · Schraubsystem
2-part · Screw system

135

PPS®-Magic ⇅ 7 – 16 mm
2-teilig · Schraubsystem mit versteckter Verschraubung, Spannfedern und Kabelkanal
2-part · Screw system with non visible screws, tension springs and cable conduit

139

FCS®-718 ⇅ 7 – 18 mm
3-teilig · Clipsystem mit 2 Schwenkebenen
3-part · Clip system with 2 swivel levels

143

Euro-Clip® ⇅ 6 – 10 mm · **Euro-Clip® XL** · **Euro-Clip® Plus** ⇅ 8 – 12/14 mm
2-teilig · Clipsystem mit Kontersteg
2-part · Clip system with counter edge

149

Mono-Clip ⇅ 7 – 22 mm
2-teilig · Clipsystem mit einem Führungssteg
2-part · Clip system with one guide rail

155

Euro-Step® Star ⇅ 4 – 9 mm · **Euro-Step® Champion** ⇅ 7 – 16 mm
2-teilig · Schraubsystem für Treppen
2-part · Screw system for stairs

159

Step-Clip Champion ⇅ 7 – 14 mm
2-teilig · Clipsystem für Treppen
2-part · Clip system for stairs

165

Preisliste
Price list

169

Fußbodenprofilssysteme für Parkett, Laminat, Kork
und mehrschichtige modulare FußbodenbelägeFloor covering profile systems for parquet, laminate,
cork and multilayer modular flooring

Ha



Vi

Treppenkanten-
profilssysteme
für HartbödenStair nosing systems for
hard floor coverings

Ha



Vi





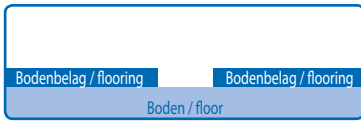

Übergangprofile und Wölbschienen

Connecting Profiles and Cover Strips



Best-Profile

■ Übergangprofile und Wölbschienen / Connecting Profiles and Cover Strips

Profile präsentieren sich heute funktional und designorientiert wie nie. Sie sollen fachgerecht verlegt werden können, von hoher Qualität und optisch ansprechend sein und sich optimal in das Raumbild einpassen. *Küberit* bietet Ihnen dafür ein umfangreiches Sortiment an Übergangprofilen und Wölbschienen mit und ohne Zierrillen aus Aluminium, Messing und Edelstahl.

Today, profiles present themselves as functional and design-oriented as never before. They should be able to be laid professionally, be of high quality and visually appealing, and fit in perfectly with the interior design. *Küberit* offers a wide range of connecting profiles and cover strips with and without decorative grooves made of aluminium, brass and stainless steel.

Übergangsprofile und Wölbschienen

Connecting Profiles and Cover Strips

Übergangsprofile – Aluminium / Connecting Profiles – Aluminium

Artikel
article

Farbe
colour

Länge
length

Version
version

458

*mittig versenkt gebohrt
oder ungebohrt
centrally countersunk drilled
and undrilled*

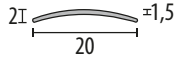

				0,9 m 1,0 m 2,7 m 5,0 m	SBS • • • •	M • • • •	U • • • •	

442

*mittig versenkt gebohrt
oder selbstklebend
centrally countersunk drilled
or self-adhesive*

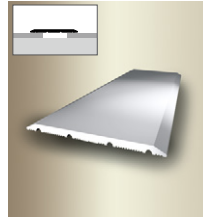
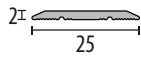

				1,0 m 3,0 m	SBS • •	M • •	SK • •	RAL/ SK • •

459

*mittig versenkt gebohrt
oder selbstklebend
centrally countersunk drilled
or self-adhesive*

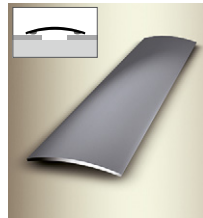
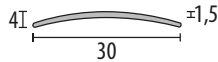

				0,9 m 1,0 m 2,7 m 3,0 m*	SBS • • • •	M • • • •	SK • • • •	H/SK • • • •
				0,9 m 2,7 m	RAL/ SK • •			

* nicht in / not in F3
** nur in / only in 1,0 m & 3,0 m

460

*mittig versenkt gebohrt
oder selbstklebend
centrally countersunk drilled
or self-adhesive*

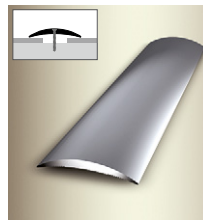
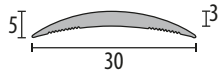

				0,9 m 1,0 m 2,7 m 5,0 m	SBS • • • •	M • • • •	SK • • • •	

461

*mittig versenkt gebohrt
centrally countersunk drilled*

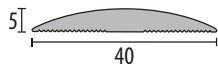

			2,7 m	SBS •	M •			

Preise finden Sie ab Seite / Prices are indicated on page 170

Übergangsprofile – Aluminium / Connecting Profiles – Aluminium

Artikel
article

441

*mittig versenkt gebohrt
oder selbstklebend
centrally countersunk drilled
or self-adhesive*

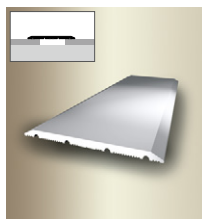
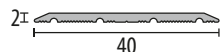

Farbe
colour

Länge
length

Version
version

Farbe	Länge	Version
F2G F3 F4 F5	0,9 m	SBS M SK H/SK
F6 F9	1,0 m	• • • •
H20 H22 H30 H31	2,7 m	• • • •
H33 H40 H61 H62	3,0 m	• • • •
H63 H64 H80 H81	5,0 m	• • • •
H95		
RAL9005		
F16		

Farbe	Länge	Version
F2G F3 F4 F5	0,9 m	SBS M SK H/SK
F6 F9	1,0 m	• • • •
H20 H22 H30 H31	2,7 m	• • • •
H33 H34 H40 H61	3,0 m	• • • •
H62 H63 H64 H65	5,0 m	• • • •
H80 H81 H95		
RAL9016 RAL9005		
F15 F16		

462

*mittig versenkt gebohrt
oder selbstklebend
centrally countersunk drilled
or self-adhesive*

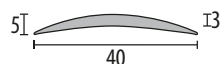

463

*mittig /seitlich versenkt gebohrt
oder selbstklebend
centrally /laterally countersunk
drilled or self-adhesive*

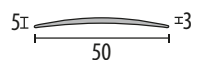

464

*mittig /seitlich versenkt gebohrt
oder selbstklebend
centrally /laterally countersunk
drilled or self-adhesive*

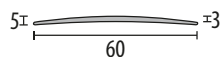

444

*versetzt versenkt gebohrt
oder selbstklebend
offset countersunk drilled
or self-adhesive*

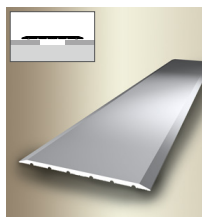
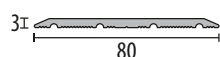

Farbe	Länge	Version
F2G F3 F4 F5	0,9 m	SBS M SK H/SK
F6 F9	1,0 m	• • • •
H20 H22 H30 H31	2,7 m	• • • •
H33 H34 H40 H61	3,0 m	• • • •
H62 H63 H64 H65	5,0 m	• • • •
H80 H81 H95		
RAL9016 RAL9005		
F15 F16		

Farbe	Länge	Version
F2G F3* F4 F5	0,9 m	SBS M SK S**
F6 F9	1,0 m	• • • •
	2,7 m	• • • •
	5,0 m	• • • •

* nur 2,7 m & 5,0 m Länge
only 2,7 m & 5,0 m length

** nur/only F4/F5

Farbe	Länge	Version
F2G F3* F4 F5	0,9 m	SBS M SK S**
F6 F9	1,0 m	• • • •
	2,7 m	• • • •
	5,0 m	• • • •

* nur für SK und 2,7 m & 5,0 m Länge
only for SK and 2,7 m & 5,0 m length

** nur/only F4/F5

Farbe	Länge	Version
F2G F3* F4 F5	0,9 m	SBS V SK RAL/SK
F6 F9	1,0 m	• • • •
RAL9005	2,7 m	• • • •
F16	3,0 m	• • • •
	5,0 m	• • • •

* nur 2,7 m & 5,0 m Länge
only 2,7 m & 5,0 m length

Preise finden Sie ab Seite / Prices are indicated on page 171

Übergangsprofile – Aluminium / Connecting Profiles – Aluminium

Artikel
article

Farbe
colour

Länge
length

Version
version

465

ungebohrt oder
mittig / seitlich versenkt gebohrt
undrilled or centrally / laterally
countersunk drilled

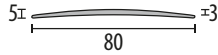

Farbe	F2G	F3*	F4	F5	F6	F9	Länge	SBS	M	U	S**
1,0 m	•	•	•	•	•	•	•	•	•	•	•
2,7 m	•	•	•	•	•	•	•	•	•	•	•
5,0 m	•	•	•	•	•	•	•	•	•	•	•

* nur 2,7 m & 5,0 m Länge
only 2,7 m & 5,0 m length

3,5

** nur/only F4/F5

466

ungebohrt oder
mittig / seitlich versenkt gebohrt
undrilled or centrally / laterally
countersunk drilled

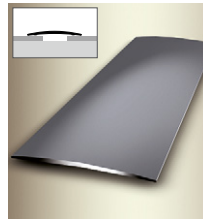
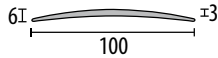

Farbe	F2G	F3*	F4	F5	F6	F9	Länge	SBS	M	U	S**
1,0 m	•	•	•	•	•	•	•	•	•	•	•
2,7 m	•	•	•	•	•	•	•	•	•	•	•
5,0 m	•	•	•	•	•	•	•	•	•	•	•

* nur 2,7 m & 5,0 m Länge
only 2,7 m & 5,0 m length

3,5

** nur/only F4/F5

Preise finden Sie ab Seite / Prices are indicated on page 173



■ Übergangsprofile – Aluminium und Messing mit Zierrillen / Connecting Profiles – Aluminium and Brass, Fluted

Artikel
article

Farbe
colour

Länge
length

Version
version

230

mittig versenkt gebohrt
oder selbstklebend, mit Zierrillen
centrally countersunk drilled
or self-adhesive, fluted

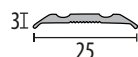

				0,9 m 1,0 m 2,7 m 5,0 m	SBS • • • •	M • • • •	SK • • • •	RAL/SK • • • •

439

mittig versenkt gebohrt
oder selbstklebend, mit Zierrillen
centrally countersunk drilled
or self-adhesive, fluted

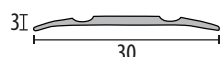

				0,9 m 1,0 m 2,7 m 5,0 m	SBS • • • •	M • • • •	SK • • • •	H/SK • • • •

440

mittig versenkt gebohrt
oder selbstklebend, mit Zierrillen
centrally countersunk drilled
or self-adhesive, fluted

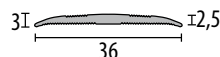

				0,9 m 1,0 m 2,7 m 5,0 m	SBS • • • •	M • • • •	SK • • • •	RAL/SK • • • •

445

mittig versenkt gebohrt,
mit Zierrillen
centrally countersunk drilled,
fluted

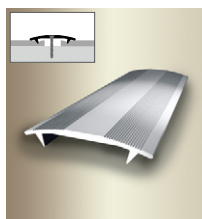
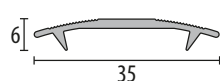

			0,9 m 2,7 m	SBS • •	M • •		

* nur 2,7 m Länge
only 2,7 m length

438

mittig versenkt gebohrt oder
selbstklebend, mit Zierrillen
centrally countersunk drilled
or self-adhesive, fluted

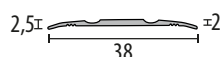

				0,9 m 1,0 m 2,7 m 3,0 m 5,0 m	SBS • • • •	M • • • •	SK • • • •	H/SK • • • •

RAL 9016 /SK
RAL 9005 /SK

0,9 m
1,0 m
2,7 m
3,0 m

** nur in / only in 1,0 m & 3,0 m

Preise finden Sie ab Seite / Prices are indicated on page 173

Übergangsprofile und Wölbschienen

Connecting Profiles and Cover Strips

Übergangsprofile – Aluminium und Messing mit Zierrillen / Connecting Profiles – Aluminium and Brass, Fluted

Artikel
article

Farbe
colour

Länge
length

Version
version

470 S

versetzt versenkt gebohrt
offset countersunk drilled

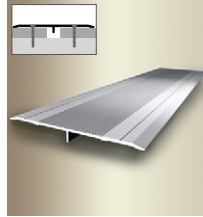
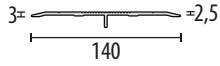

F2	F4				
		3,0 m	SBS •	V •	

231

mittig versenkt gebohrt oder
selbstklebend
centrally countersunk drilled
or self-adhesive

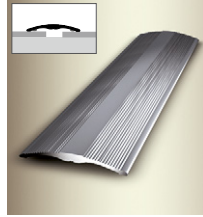
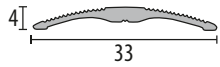

F2	F4	F5	F6					
				1,0 m	SBS •	M •	SK •	RAL/ SK •
				2,7 m	•	•	•	•
				3,0 m	•	•	•	•
				5,0 m	•	•	•	•
F9								
RAL9005								
F16								

Preise finden Sie ab Seite / Prices are indicated on page 175



470 S

Wölbischiene – Edelstahl und Messing / Cover Strips – Stainless Steel and Brass

Artikel
article

Farbe
colour

Länge
length

Version
version

471

ungebohrt, mittig / seitlich
versenkt gebohrt oder
selbstklebend, mit Schutzfolie
undrilled, centrally / laterally
countersunk drilled or self-
adhesive, with protective film

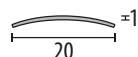

Farbe	Länge	Version
F8 F8G	0,9 m	SBS M SK U/S
	1,0 m	• • • •
	2,7 m	• • • •
	5,0 m	• • • •
	 3,0	

450

mittig versenkt gebohrt,
mit Schutzfolie
centrally countersunk drilled,
with protective film

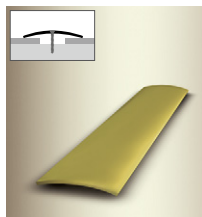
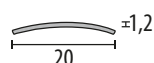

Farbe	Länge	Version
F7	0,9 m	SBS M
	1,0 m	• •
	2,7 m	• •
	5,0 m	• •
	 3,0	

472

ungebohrt, mittig / seitlich
versenkt gebohrt oder
selbstklebend, mit Schutzfolie
undrilled, centrally / laterally
countersunk drilled or self-
adhesive, with protective film

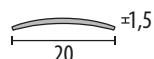

Farbe	Länge	Version
F8 F8G	0,9 m	SBS M SK U/S
	1,0 m	• • • •
	2,7 m	• • • •
	5,0 m	• • • •
	 3,0	

451

ungebohrt, mittig / seitlich
versenkt gebohrt oder
selbstklebend, mit Schutzfolie
undrilled, centrally / laterally
countersunk drilled or self-
adhesive, with protective film

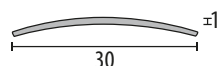

Farbe	Länge	Version
F7 F8 F8G	0,9 m	SBS M SK U/S
	1,0 m	• • • •
	2,7 m	• • • •
	5,0 m	• • • *
	 3,0	
		* nur/only F8/F8G

453

mittig versenkt gebohrt oder
selbstklebend, mit Schutzfolie
centrally countersunk drilled or
self-adhesive, with protective film

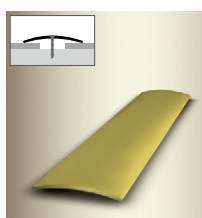
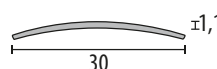

Farbe	Länge	Version
F7	1,0 m	SBS M SK
	2,7 m	• • •
	 3,0	

452

ungebohrt, mittig / seitlich
versenkt gebohrt oder
selbstklebend, mit Schutzfolie
undrilled, centrally / laterally
countersunk drilled or self-
adhesive, with protective film

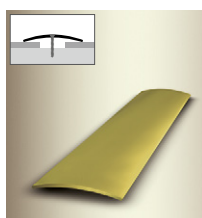
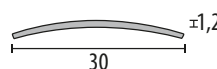

Farbe	Länge	Version
F7	0,9 m	SBS M/S SK U
	1,0 m	• • • •
	2,7 m	• • • •
	5,0 m	• • • •
	 3,0	

473

ungebohrt, mittig / seitlich
versenkt gebohrt oder
selbstklebend, mit Schutzfolie
undrilled, centrally / laterally
countersunk drilled or self-
adhesive, with protective film

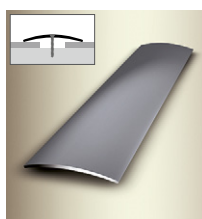
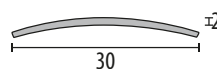

Farbe	Länge	Version
F8 F8G	0,9 m	SBS M SK U/S
	1,0 m	• • • •
	2,7 m	• • • •
	5,0 m	• • • •
	 3,0	

Preise finden Sie ab Seite / Prices are indicated on page 175

Wölbschienen – Edelstahl und Hartmessing / Cover Strips – Stainless Steel and Brass

Artikel
article

Farbe
colour

Länge
length

Version
version

456

ungebohrt, mittig / seitlich
versenkt gebohrt, mit Schutzfolie
undrilled, centrally / laterally
countersunk drilled,
with protective film

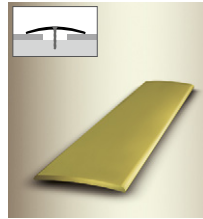
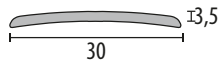

	F7
--	----

5,4 m	SBS	M/S	U
2,7 m	•	•	•

457

ungebohrt, mittig / seitlich
versenkt gebohrt, mit Schutzfolie
undrilled, centrally / laterally
countersunk drilled,
with protective film

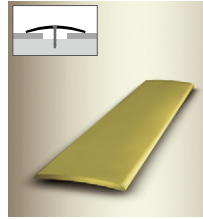
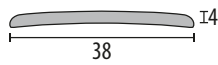

	F7
--	----

5,4 m	SBS	M/S	U
2,7 m	•	•	•

454

ungebohrt, mittig / seitlich
versenkt gebohrt, mit Schutzfolie
undrilled, centrally / laterally
countersunk drilled,
with protective film

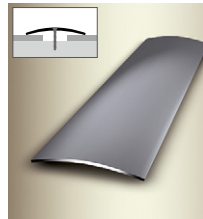
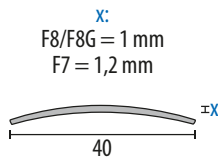

	F7		F8		F8G
--	----	--	----	--	-----

0,9 m	SBS	M/S	U
1,0 m	•	•	•
2,7 m	•	•	•
5,0 m	•	•	•

474

ungebohrt, mittig / seitlich
versenkt gebohrt, mit Schutzfolie
undrilled, centrally / laterally
countersunk drilled,
with protective film

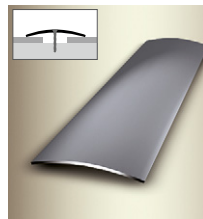
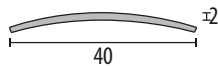

	F8		F8G
--	----	--	-----

2,7 m	SBS	M/S	U
5,0 m	•	•	•

455

ungebohrt, mittig / seitlich
versenkt gebohrt, mit Schutzfolie
undrilled, centrally / laterally
countersunk drilled,
with protective film

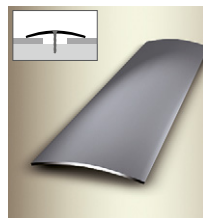
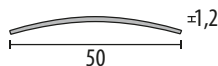

	F7		F8		F8G
--	----	--	----	--	-----

0,9 m	SBS	M/S	U
1,0 m	•	•	•
2,7 m	•	•	•
5,0 m	•	•	•

475

ungebohrt, mittig / seitlich
versenkt gebohrt, mit Schutzfolie
undrilled, centrally / laterally
countersunk drilled,
with protective film

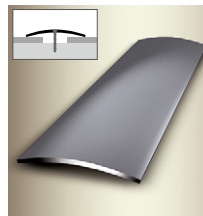
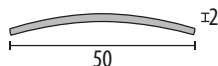

	F8		F8G
--	----	--	-----

2,7 m	SBS	M/S	U
5,0 m	•	•	•

167

ungebohrt, mittig / seitlich
versenkt gebohrt, mit Schutzfolie
undrilled, centrally / laterally
countersunk drilled,
with protective film

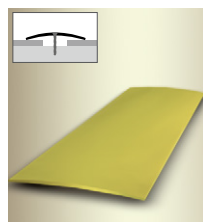
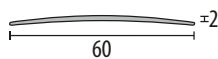

	F7
--	----

2,5 m	SBS	M/S	U
5,0 m	•	•	•

Preise finden Sie ab Seite / Prices are indicated on page 176

- Wölbischiene – Edelstahl und Hartmessing / Cover Strips – Stainless Steel and Brass



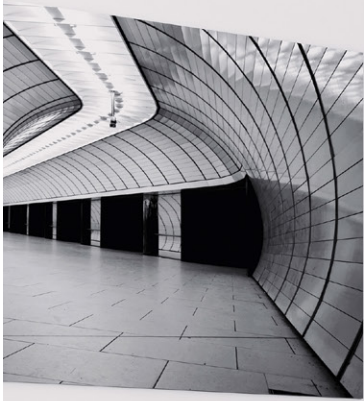

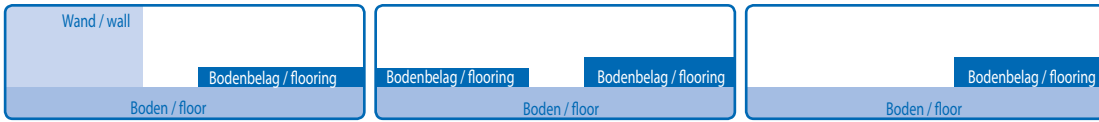

Anpassungs-, Abschluss-, Einfass- und Rampenprofile

Adapting Profiles, Edge Trims and Ramp Profiles



Best-Profile

- Anpassungs-, Abschluss-, Einfass- und Rampenprofile / Adapting Profiles, Edge Trims and Ramp Profiles

Diese Profile sind optimal für den Objektbau, aber auch bei der Bodenverlegung im privaten Wohnbereich geeignet. Innovative Produkte für Standard-Anwendungen und Speziallösungen, die für die professionelle Verlegung von Parkett und Laminat sowie elastische oder textile Bodenbeläge äußerst hilfreich sind. Ganz gleich ob Sie einen LVT-Belag, Teppichboden oder Hartbelag verlegen möchten – *Küberit* hat das passende Profil.

These profiles are ideal for commercial construction, but also for laying floors in private homes. Innovative products for standard applications and special solutions, which are extremely useful for the professional laying of parquet and laminate flooring as well as resilient or textile floor coverings. No matter if you want to lay LVT flooring or carpet – *Küberit* has the suitable profile.

■ Anpassungsprofile / Adapting Profiles

Artikel
article

250

seitlich versenkt oder
ungebohrt
laterally countersunk
or undrilled

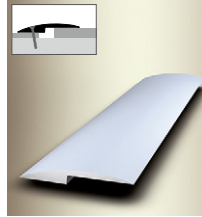
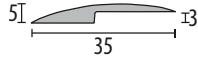

Farbe
colour

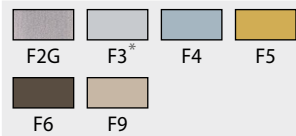

* nur seitlich versenkt
only laterally countersunk

Länge
length

0,9 m
2,7 m
5,0 m



Version
version

SBS	S	U
•	•**	•
•	•	•
•	•	•

** nur/only F4

240

versenkt gebohrt oder
selbstklebend, mit Zierrillen
countersunk drilled or
self-adhesive, fluted

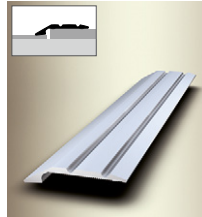
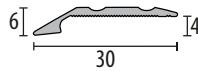

Farbe
colour

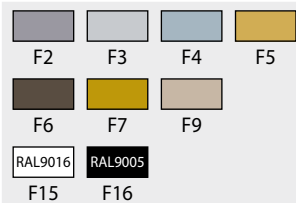

Länge
length

0,9 m
1,0 m
2,7 m
5,0 m



SBS	V	SK	RAL/SK
•	•	•	•
•	•	•*	•
•	•	•	•
•	•	•	•

* nur Farben F2, F4 & F9
only colours F2, F4 & F9

244

versenkt gebohrt oder
selbstklebend, mit Zierrillen
countersunk drilled or
self-adhesive, fluted

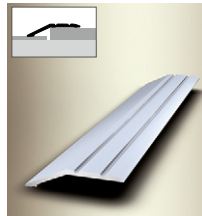
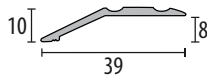

Farbe
colour



Länge
length

0,9 m
1,0 m
2,7 m
3,0 m



SBS	V	SK	H/SK
•	•	•	•
•	•*	•*	•
•	•	•	•
•	•	•	•

RAL/SK
•
•
•**

* nur Farben F2, F4 & F9
only colours F2, F4 & F9
** nur Farbe RAL 9005
only colour RAL 9005

241

versenkt gebohrt oder
selbstklebend, mit Zierrillen
countersunk drilled or
self-adhesive, fluted

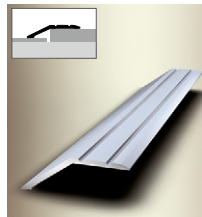
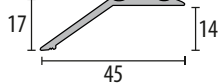

Farbe
colour



Länge
length

0,9 m
2,7 m
3,0 m



SBS	V	SK	H/SK
•	•	•	•
•	•	•	•
•	•	•	•

RAL/SK
•
•*

* nur Farbe RAL 9005
only colour RAL 9005

245

versenkt gebohrt oder
selbstklebend, mit Zierrillen
countersunk drilled or
self-adhesive, fluted

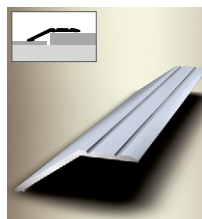
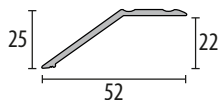

Farbe
colour

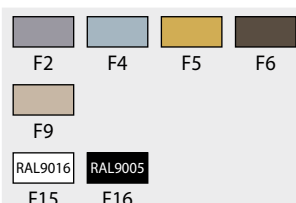

Länge
length

0,9 m
2,7 m
5,0 m



SBS	V	SK	RAL/SK
•	•	•	•
•	•	•	•
•	•	•	•

Preise finden Sie ab Seite / Prices are indicated on page 177

■ Anpassungsprofile / Adapting Profiles

Artikel
article

243

versenkt gebohrt, mit Zierrillen
countersunk drilled, fluted

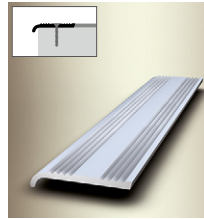
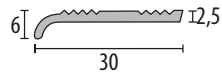

Farbe
colour

Länge
length

Version
version

			1,0 m	SBS	V		
			2,5 m	•	•		
			5,0 m	•	•*		
							* nur Farbe F7 only colour F7

247

versenkt gebohrt oder
selbstklebend, mit Zierrillen
countersunk drilled or
self-adhesive, fluted

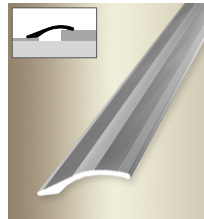
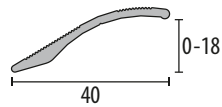

				0,9 m	SBS	V	SK	H/SK
				1,0 m	•	•*	•***	•
				2,7 m	•	•**	•	•
				3,0 m	•	•***	•	•
					RAL/ SK			
				0,9 m	•			
				1,0 m	•			
				2,7 m	•			
				3,0 m	•			
								* nur Farbe F7 only colour F7 ** nicht Farbe F7 not colour F7 *** nur Farben F2, F4, F9 only colours F2, F4, F9

248

versenkt gebohrt oder
selbstklebend
countersunk drilled or
self-adhesive

glatte Oberfläche
smooth surface

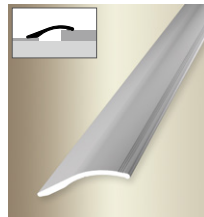
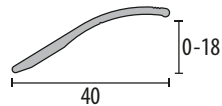

				1,0 m	SBS	V	SK	RAL/SK
				2,7 m	•	•*	•*	•
				3,0 m	•	•	•	•
								* nicht Farbe F4G not colour F4G

Preise finden Sie ab Seite / Prices are indicated on page 178



247

Abschluss- und Einfassprofile / Edge Trims

380

umschlagbar, versenkt gebohrt
oder selbstklebend
adaptable, countersunk drilled or
self-adhesive

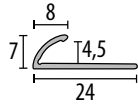

				0,9 m 2,7 m 5,0 m	SBS • • •	V • • •	SK • • •

390

umschlagbar, versenkt gebohrt
oder selbstklebend
adaptable, countersunk drilled or
self-adhesive

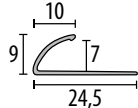

				0,9 m 2,7 m 5,0 m	SBS • • •	V • • •	SK • • •	T* • • •
					* Details in der Preisliste details see pricelist			

370

umschlagbar, versenkt gebohrt
oder selbstklebend
adaptable, countersunk drilled or
self-adhesive

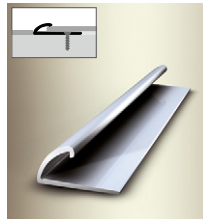
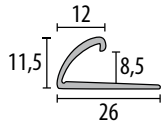

				0,9 m 1,0 m 2,7 m 5,0 m	SBS • • • •	V • • • •	SK • • • •	T* • • • •
					* Details in der Preisliste details see pricelist			

371

umschlagbar, versenkt gebohrt
adaptable, countersunk drilled

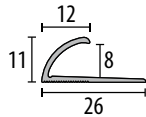

				0,9 m 2,7 m 5,0 m	SBS • • •	V •* • •**	SK	T*
					* nur für/only for F9 ** nicht für/not for F7			

382

Doppel-Abschlussprofil, mit
4 Sollbiegestellen, umschlagbar,
versenkt gebohrt, gerillt
Double edge trim, with
4 predetermined bending points,
adaptable, countersunk drilled, fluted

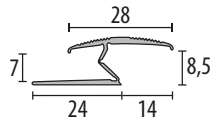

				0,9 m 1,0 m 2,7 m 5,0 m	SBS • • • •	V • • • •	H/T	T* • • • •
					* Details in der Preisliste details see pricelist			

Preise finden Sie ab Seite / Prices are indicated on page 179



Zubehör / Accessories



Hartholzzulage mit Filz
hardwood log with felt

Preise finden Sie auf Seite / Prices are indicated on page 203

■ Abschluss- und Einfassprofile / Edge Trims

383

Doppel-Abschlussprofil, mit 4 Sollbiegestellen, umschlagbar, versenkt gebohrt, gerillt
 Double edge trim, with 4 predetermined bending points, adaptable, countersunk drilled, fluted

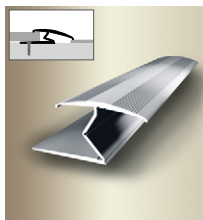
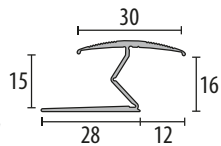

				0,9 m 2,7 m	SBS	V		T*
					•	•		
					•	•		•
					* Details in der Preisliste details see pricelist			

355

versenkt gebohrt
 countersunk drilled

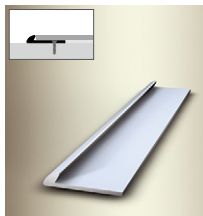
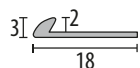

				1,0 m 2,5 m 5,0 m	SBS	V	RAL	
					•	•		
					•	•*	•	
F15	F16				* nicht für/not for F3			

356

versenkt gebohrt
 countersunk drilled

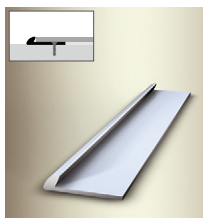
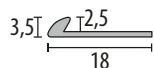

				1,0 m 2,5 m 5,0 m	SBS	V		
					•	•		
					•	•*		
					* nicht für/not for F3			

357

versenkt gebohrt
 countersunk drilled

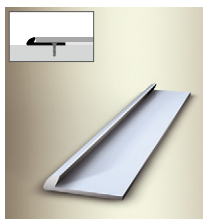
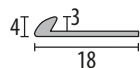

				1,0 m 2,5 m 5,0 m	SBS	V		
					•	•		
					•	•*		
					* nicht für/not for F3 & F7			

358

versenkt gebohrt
 countersunk drilled

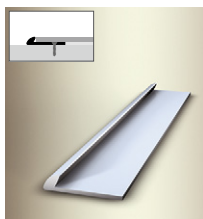
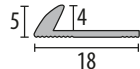

				1,0 m 2,5 m 5,0 m	SBS	V		
					•	•		
					•	•*		
					* nicht für/not for F3			

359

versenkt gebohrt
 countersunk drilled

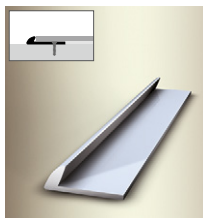
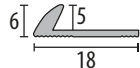

				1,0 m 2,5 m 5,0 m	SBS	V		
					•	•		
					•	•*		
					* nicht für/not for F3 & F7			

Preise finden Sie ab Seite / Prices are indicated on page 180

Abschluss- und Einfassprofile / Edge Trims

Artikel
article

Farbe
colour

Länge
length

Version
version

361/3

versenkt gebohrt
countersunk drilled

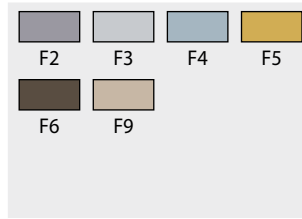
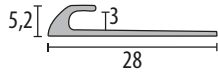

1,0 m	SBS	V		
2,5 m	•	•*		
5,0 m	•	•		
	•	•**		

* nur für/only for F2 & F4
** nicht für/not for F3

361/3.5

versenkt gebohrt
countersunk drilled

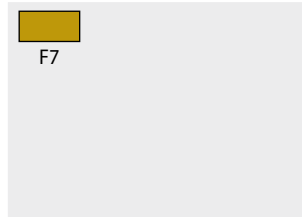
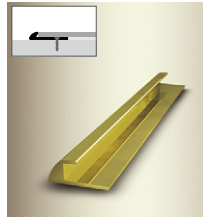
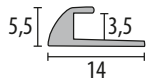

1,0 m	SBS	V		
2,5 m	•	•		

362

versenkt gebohrt
countersunk drilled

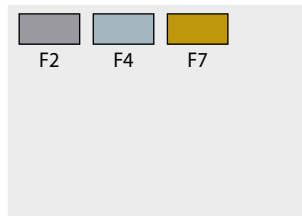
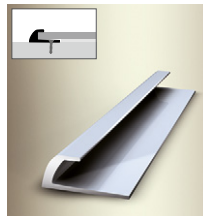

1,0 m	SBS	V		
2,5 m	•	•		
5,0 m	•	•*		

* nicht für/not for F7

341

versenkt gebohrt
countersunk drilled

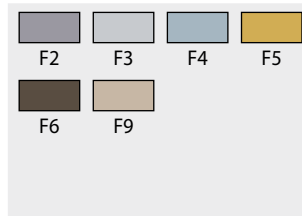
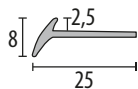

1,0 m	SBS	V		
2,5 m	•	•		
5,0 m	•	•*		

* nicht für/not for F3

342

versenkt gebohrt
countersunk drilled

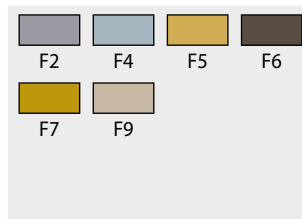
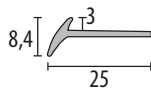

2,5 m	SBS	V		
5,0 m	•	•*		

* nicht für/not for F7

364

versenkt gebohrt,
für CV- und PVC-Böden
countersunk drilled,
for CV and PVC floorings

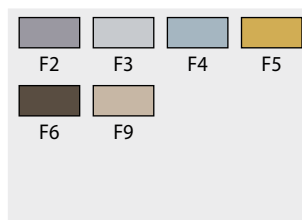
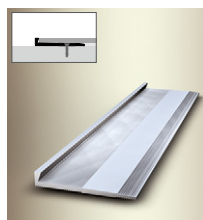
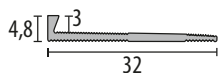

1,0 m	SBS	V		
3,0 m	•	•		

Preise finden Sie ab Seite / Prices are indicated on page 180

■ Abschluss- und Einfassprofile / Edge Trims

Artikel
article

Farbe
colour

Länge
length

Version
version

363

versenkt gebohrt,
für CV- und PVC-Böden
countersunk drilled,
for CV and PVC floorings

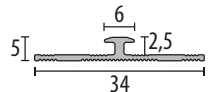

				2,7 m	SBS •	V •		
F2	F4	F5	F6					
F9								

365

versenkt gebohrt,
für CV- und PVC-Böden
countersunk drilled,
for CV and PVC floorings

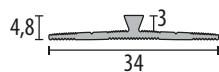

				1,0 m 3,0 m	SBS •	V •	RAL/V •	
F2	F3	F4	F5					
F6	F9							
RAL9016	RAL9005							
F15	F16							

366

versenkt gebohrt,
für CV- und PVC-Böden
countersunk drilled,
for CV and PVC floorings

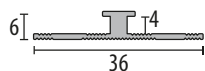

				2,7 m	SBS •	V •		
F2	F3	F4	F5					
F6	F9							

368

versenkt gebohrt,
für CV- und PVC-Böden
countersunk drilled,
for CV and PVC floorings

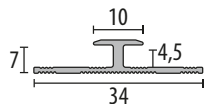

				2,7 m	SBS •	V •		
F2	F4	F5	F6					
F9								

367

versenkt gebohrt,
für CV- und PVC-Böden
countersunk drilled,
for CV and PVC floorings

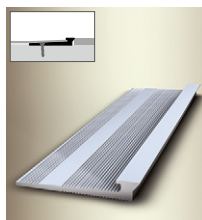
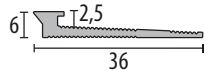

				2,7 m	SBS •	V •		
F2	F3	F4	F5					
F6	F9							

369 SK

selbstklebend, mit Zierrillen
self-adhesive, fluted

Unter Berücksichtigung von
Mindestabnahmemengen können
alle Aluminiumprofile auch mit weiteren
Farben in Pulverbeschichtung geliefert
werden!
All aluminium profiles can be delivered on
request with additional colours in powder
coating. Minimum quantities required.

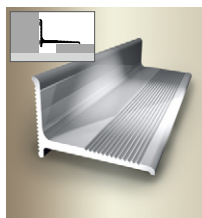
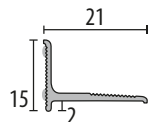

				2,7 m 2,0 m	SBS •	SK •	H/ SK •	RAL/ SK • •*
F2	F4	F5	F6					
F9								
H20	H22	H30	H31					
H33	H40	H61	H62					
H63	H64	H80	H81					
H95								
RAL9016	RAL7016							
F15	F18							

Preise finden Sie ab Seite / Prices are indicated on page 181

■ Abschluss- und Einfassprofile / Edge Trims

Artikel
article

Farbe
colour

Länge
length

Version
version

369 N/SK

selbstklebend (2x)
self-adhesive (2x)

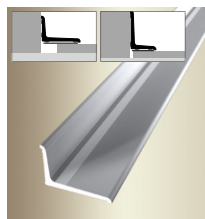
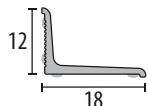

				2,7 m	SBS	SK	RAL/SK
					•	•	•
F15	F18						

238 N/SK

selbstklebend
self-adhesive

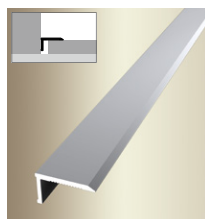
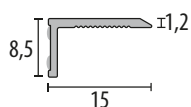

				2,7 m	SBS	SK	
					•	•	

292

mit Einschub, versenkt
gebohrt, mit Zierrillen
floors can be inserted,
countersunk drilled, fluted

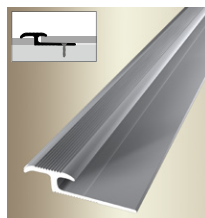
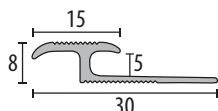

				2,7 m	SBS	V	
					•	•	

292 R

Revisionsrahmen,
verschweißt
floor access cover frame,
welded

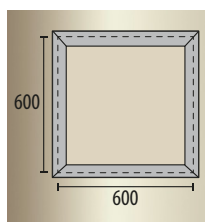
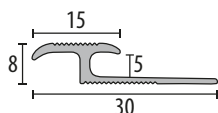

				0,6 m x 0,6 m	SBS	V	RAL/V
					•	•	•

Preise finden Sie ab Seite / Prices are indicated on page 181



Unter Berücksichtigung von Mindestabnahmemengen können alle Aluminiumprofile auch mit weiteren Farben in Pulverbeschichtung geliefert werden!

All aluminium profiles can be delivered on request with additional colours in powder coating. Minimum quantities required.

369 SK

■ Abschluss- und Einfassprofile / Edge Trims

Artikel
article

Farbe
colour



Länge
length

Version
version

297

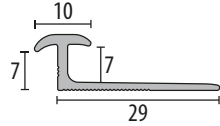
mit Einschub, versenkt
gebohrt, mit Zierrillen
floors can be inserted,
countersunk drilled, fluted

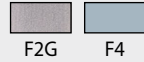



 F2G F4	2,7 m	SBS •	V •		
	 3,0				

297 R

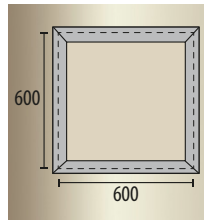
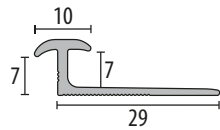
Revisionsrahmen,
verschweißt
floor access cover frame,
welded

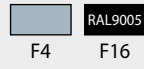



 F4 F16	0,6 m x 0,6 m	SBS •	V •	RAL/V •	
	 3,0				

223

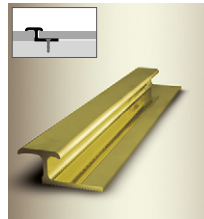
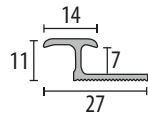
mit Einschub, versenkt
gebohrt, mit Zierrillen
floors can be inserted,
countersunk drilled, fluted





 F7	2,7 m	SBS •	V •		
	 3,0				

294

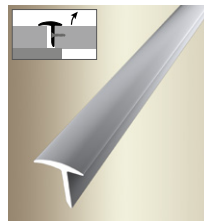
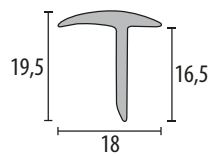
versenkt gebohrt
countersunk drilled



 F2 F4	5,0 m 2,5 m	SBS • •	V • •		
 RAL9005 F16					
	 3,0				

Preise finden Sie ab Seite / Prices are indicated on page **181**



© Küberit®

292

Abschluss- und Einfassprofile / Edge Trims

Artikel
article

Farbe
colour

Länge
length

Version
version

345
versenkt gebohrt,
für CV- und PVC-Böden
countersunk drilled,
for CV and PVC floorings

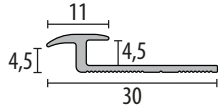

F2G	F3	F4	F9
RAL9005			
F16			

3,0 m	SBS •	V •		

346
versenkt gebohrt,
für CV- und PVC-Böden
countersunk drilled,
for CV and PVC floorings

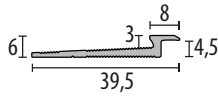

F2G	F3	F4	F9

3,0 m	SBS •	V •		

801
mit Einschub, versenkt
gebohrt, glatt
floors can be inserted,
countersunk drilled, plain

glatte Oberfläche
smooth surface

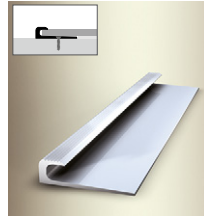
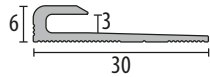

F2G	F3	F4	F9

2,5 m 5,0 m	SBS • •	V • •		

802
mit Einschub, versenkt
gebohrt, glatt
floors can be inserted,
countersunk drilled, plain

glatte Oberfläche
smooth surface

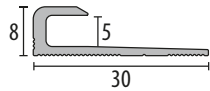

F2G	F3	F4	F9

2,5 m 5,0 m	SBS • •	V • •		

803
mit Einschub, versenkt
gebohrt, glatt
floors can be inserted,
countersunk drilled, plain

glatte Oberfläche
smooth surface

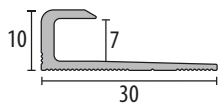

F2G	F3	F4	F9

2,5 m 5,0 m	SBS • •	V • •		

804
mit Einschub, versenkt
gebohrt, mit Zierrillen
floors can be inserted,
countersunk drilled, fluted

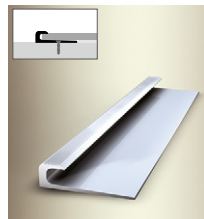
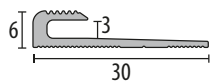

F2	F3	F4	F5
F6	F9		

1,0 m 2,5 m 5,0 m	SBS • • •	V • • •		

Preise finden Sie ab Seite / Prices are indicated on page 181

■ Abschluss- und Einfassprofile / Edge Trims

Artikel
article

Farbe
colour

Länge
length

Version
version

806

mit Einschub, versenkt
gebohrt, mit Zierrillen
floors can be inserted,
countersunk drilled, fluted

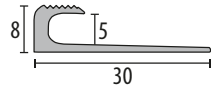

				1,0 m 2,5 m 5,0 m	SBS • • •	V • • •			

805

mit Einschub, versenkt
gebohrt, mit Zierrillen
floors can be inserted,
countersunk drilled, fluted

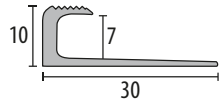

				1,0 m 2,5 m 5,0 m	SBS • • •	V • • •			

011

mit Einschub, versenkt
gebohrt, glatt
floors can be inserted,
countersunk drilled, plain

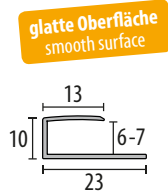

				2,7 m	SBS •	V •			

010

mit Einschub, versenkt
gebohrt, glatt
floors can be inserted,
countersunk drilled, plain

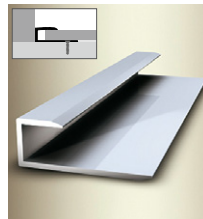
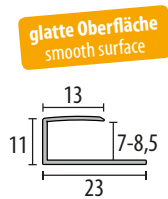

				2,7 m	SBS •	V •			

012

mit Einschub, versenkt
gebohrt, glatt
floors can be inserted,
countersunk drilled, plain

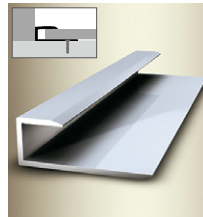
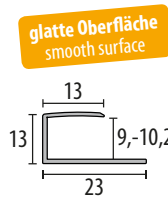

				2,7 m	SBS •	V •			

015

mit Einschub, versenkt
gebohrt, glatt
floors can be inserted,
countersunk drilled, plain

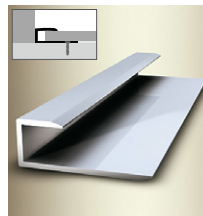
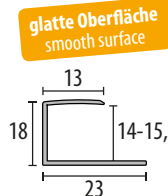

				2,7 m	SBS •	V •			

Preise finden Sie ab Seite / Prices are indicated on page 182

Abschluss- und Einfassprofile / Edge Trims

Artikel
article

211

für Laminat, versenkt
gebohrt, mit Kleberillen
for laminate, countersunk
drilled, fluted for glueing

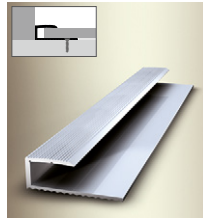
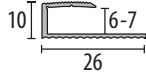

Farbe
colour

Länge
length

Version
version

				0,9 m 2,7 m	SBS • •	V • •	H/V • •
F2	F4	F5	F6				
F9							
H20	H22	H30	H31				
H33	H40	H61	H62				
H63	H64	H80	H81				
H95							



210

für Laminat, versenkt
gebohrt, mit Kleberillen
for laminate, countersunk
drilled, fluted for glueing

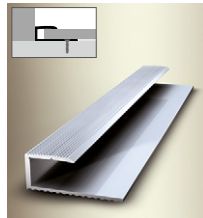
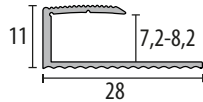

				0,9 m 2,7 m	SBS • •	V • •	H/V • •
F2	F4	F5	F6				
F9							
H20	H22	H30	H31				
H33	H40	H61	H62				
H63	H64	H80	H81				
H95							



212

für Laminat, versenkt
gebohrt, mit Kleberillen
for laminate, countersunk
drilled, fluted for glueing

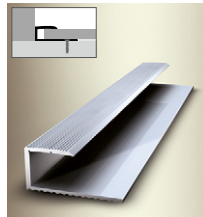
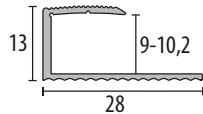

				0,9 m 2,7 m	SBS • •	V • •	H/V • •
F2	F4	F5	F6				
F9							
H20	H22	H30	H31				
H33	H40	H61	H62				
H63	H64	H80	H81				
H95							



Preise finden Sie ab Seite / Prices are indicated on page 182

■ Abschluss- und Einfassprofile / Edge Trims

Artikel
article

Farbe
colour

Länge
length

Version
version

213

für Parkett und Laminat,
versenkt gebohrt, mit Kleberillen
for parquet and laminate,
countersunk drilled, fluted for glueing

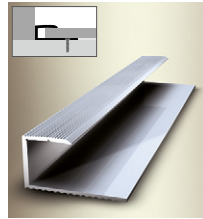
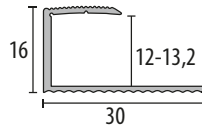

				0,9 m 2,7 m	SBS • •	V • •	H/V • •
F2	F4	F5	F6				
F9							
H20	H22	H30	H31				
H33	H40	H61	H62				
H63	H64	H80	H81				
H95							

DIGITAL PRINT DECOR COATING
by Küberit

3,0

214

für Parkett, versenkt
gebohrt, mit Kleberillen
for parquet, countersunk
drilled, fluted for glueing

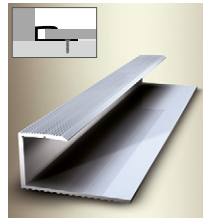
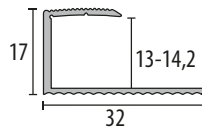

				0,9 m 2,7 m	SBS • •	V • •	H/V • •
F2	F4	F5	F6				
F9							
H20	H22	H30	H31				
H33	H40	H61	H62				
H63	H64	H80	H81				
H95							

DIGITAL PRINT DECOR COATING
by Küberit

3,0

215

für Parkett, versenkt
gebohrt, mit Kleberillen
for parquet, countersunk
drilled, fluted for glueing

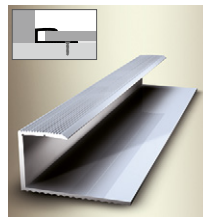
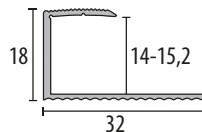

				0,9 m 2,7 m	SBS • •	V • •	H/V • •
F2	F4	F5	F6				
F9							
H20	H22	H30	H31				
H33	H40	H61	H62				
H63	H64	H80	H81				
H95							

DIGITAL PRINT DECOR COATING
by Küberit

3,0

Preise finden Sie ab Seite / Prices are indicated on page 183

■ Abschluss- und Einfassprofile / Edge Trims

Artikel
article

Farbe
colour

Länge
length

Version
version

217

für Parkett, versenkt
gebohrt, mit Kleberillen
for parquet, countersunk
drilled, fluted for glueing

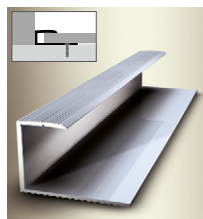
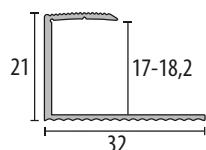

				0,9 m 2,7 m	SBS • •	V • •		

219

für Parkett, versenkt
gebohrt, mit Kleberillen
for parquet, countersunk
drilled, fluted for glueing

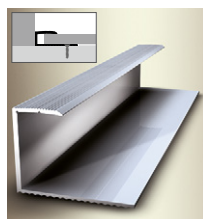
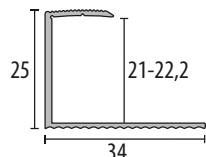

				0,9 m 2,7 m	SBS • •	V • •		

192

versenkt gebohrt,
mit Kleberillen, glatt
countersunk drilled,
fluted for glueing, plain

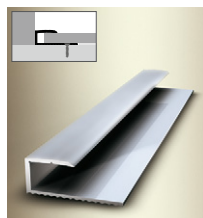
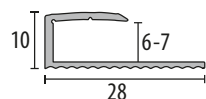

				2,7 m	SBS •	V •		

196

versenkt gebohrt,
mit Kleberillen, glatt
countersunk drilled,
fluted for glueing, plain

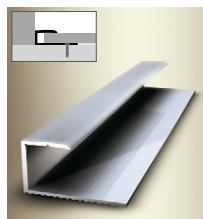
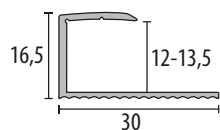

				2,7 m	SBS •	V •		

Preise finden Sie ab Seite / Prices are indicated on page 183

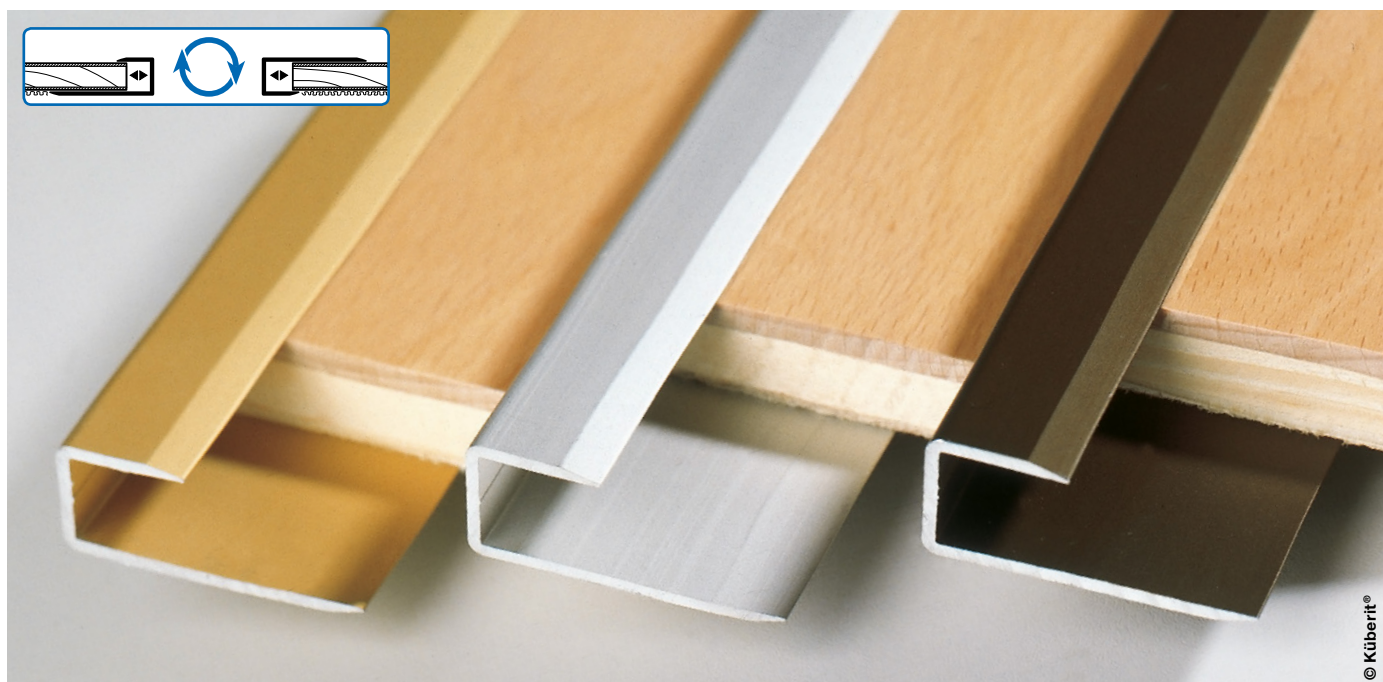

■ Abschluss- und Einfassprofile / Edge Trims

Artikel
article

Farbe
colour

Länge
length

Version
version

200 U

für Laminat, ungebohrt,
beidseitig montierbar
for laminate, undrilled,
installation possible
from either side

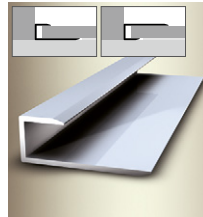
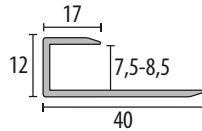

				0,9 m 2,7 m	SBS • •	U • •		

201 U

für Parkett und Laminat, ungebohrt,
beidseitig montierbar
for parquet and laminate,
undrilled, installation possible
from either side

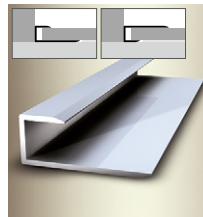
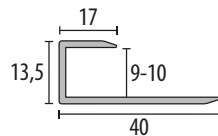

				0,9 m 2,7 m	SBS • •	U • •		

202 U

für Parkett und Laminat, ungebohrt,
beidseitig montierbar
for parquet and laminate,
undrilled, installation possible
from either side

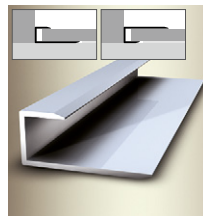
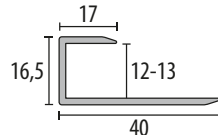

				0,9 m 2,7 m	SBS • •	U • •*		

* nur für/only for F2 & F4

203 U

für Parkett, ungebohrt,
beidseitig montierbar
for parquet, undrilled,
installation possible
from either side

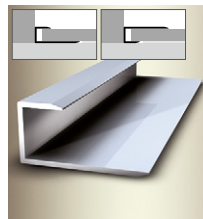
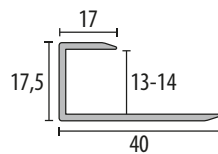

				0,9 m 2,7 m	SBS • •	U • •*		

* nur für/only for F2 & F4

204 U

für Parkett, ungebohrt,
beidseitig montierbar
for parquet, undrilled,
installation possible
from either side

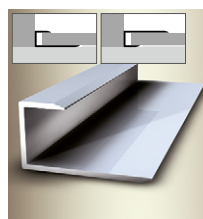
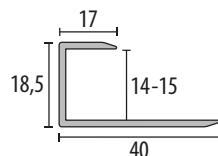

				0,9 m 2,7 m	SBS • •	U • •		

221

für Laminat, versenkt
gebohrt, mit Kleberillen
for laminate, countersunk
drilled, fluted for glueing

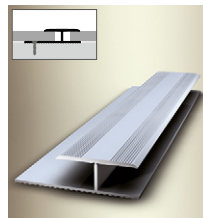
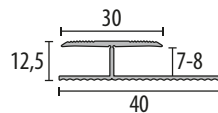

			0,9 m 2,7 m	SBS • •	V • •		

222

für Laminat, versenkt
gebohrt, mit Kleberillen
for laminate, countersunk
drilled, fluted for glueing

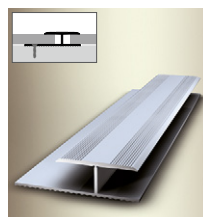
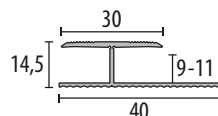

			0,9 m 2,7 m	SBS • •	V • •		

Preise finden Sie ab Seite / Prices are indicated on page 183

Rampenprofile / Ramp Profiles

Artikel
article

Farbe
colour

Länge
length

Version
version

260

belastbare Rampe für
Schwerlasten, versenkt gebohrt
heavy-duty ramp for heavy
weights, countersunk drilled

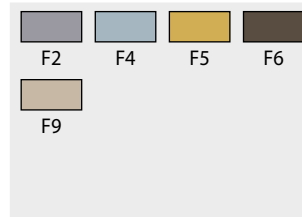
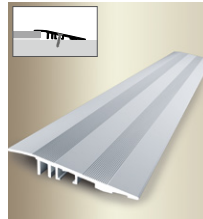
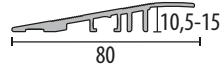

2,7 m	SBS •	V •		
	3,5			

268

belastbare Rampe für
Schwerlasten, versenkt gebohrt
heavy-duty ramp for heavy
weights, countersunk drilled

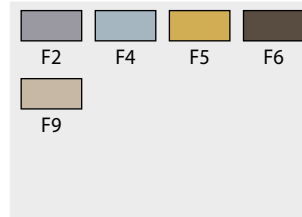
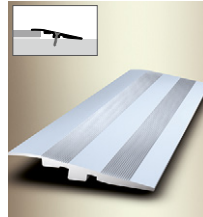
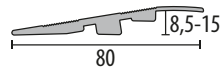

2,7 m	SBS •	V •		
	3,5			

330

versenkt gebohrt
countersunk drilled

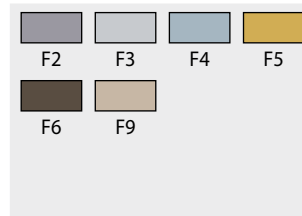
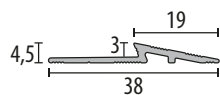

2,7 m	SBS •	V •		
	3,0			

332

versenkt gebohrt
countersunk drilled

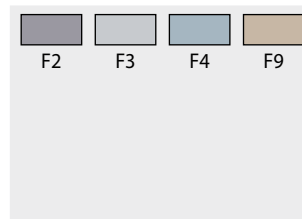
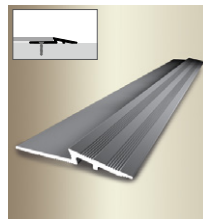
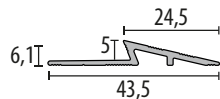

2,7 m	SBS •	V •		
	3,0			

264

ungebohrt oder
versenkt gebohrt
undrilled or
countersunk drilled

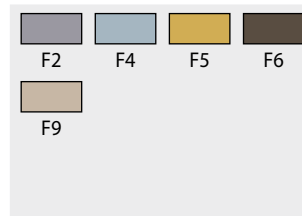
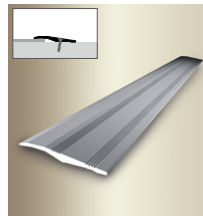
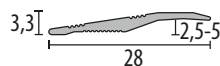

0,9 m 2,7 m	SBS • •	V • •*	U • •	
	3,0			* nicht für/not for F5 & F6

265

ungebohrt oder
versenkt gebohrt
undrilled or
countersunk drilled

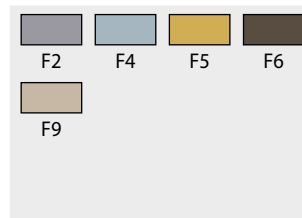
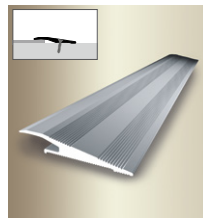
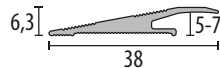

0,9 m 2,7 m	SBS • •	V • •*	U • •*	
	3,0			* nicht für/not for F5 & F6

269 U

ungebohrt, mit Verbindern,
undrilled, with connectors,

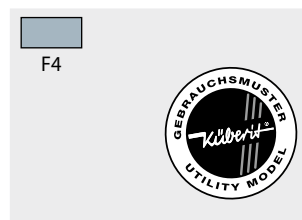
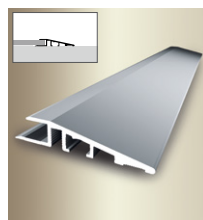
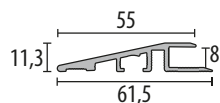

3,0 m	SBS •		U •	
-------	----------	--	--------	--

Preise finden Sie ab Seite / Prices are indicated on page 184

■ Rampenprofile / Ramp Profiles

Artikel
article

Farbe
colour

Länge
length

Version
version

269 EC

90° Ecke für Typ 269 U,
mit Verbindern, ungebohrt
90° corner for type 269 U,
with connectors, undrilled

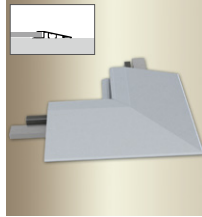
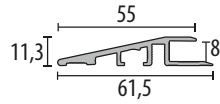

F4	0,2 m x 0,2 m	SBS •	U/EC •
----	---------------------	----------	-----------

270 N U

ungebohrt, mit Verbindern,
mit oder ohne Dichtlippe
undrilled, with connectors,
with or without sealing lips

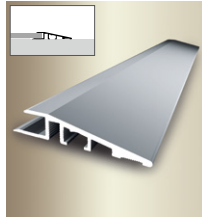
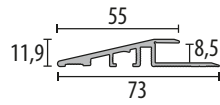

F4	3,15 m	SBS •	U •
----	--------	----------	--------

270 NEC

90° Ecke für Typ 270 N U,
mit Verbindern, ungebohrt,
mit oder ohne Dichtlippe
90° corner for type 270 N U,
with connectors, undrilled,
with or without sealing lips

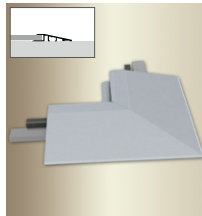
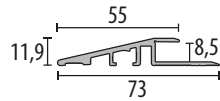

F4	0,2 m x 0,2 m	SBS •	U/EC •
----	---------------------	----------	-----------

Preise finden Sie ab Seite / Prices are indicated on page 184



© Küberit®

265

Rampenprofile / Ramp Profiles

Artikel
article

Farbe
colour

Länge
length

Version
version

262 U

ungebohrt, mit Verbindern,
mit oder ohne Dichtlippe
undrilled, with connectors,
with or without sealing lips

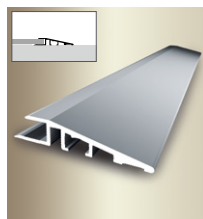
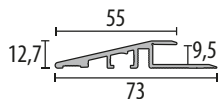

F4	3,15 m	SBS •	U •
----	--------	----------	--------

262 EC

90° Ecke für Typ 262 U,
mit Verbindern, ungebohrt,
mit oder ohne Dichtlippe
90° corner for type 262 U,
with connectors, undrilled,
with or without sealing lips

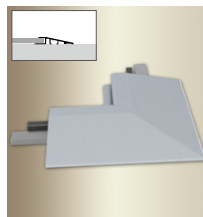
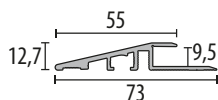

F4	0,2 m x 0,2 m	SBS •	U/EC •
----	---------------------	----------	-----------

261 U

ungebohrt, mit Verbindern
undrilled, with connectors

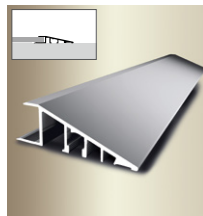
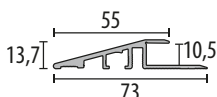

F4	3,0 m	SBS •	U •
----	-------	----------	--------

Preise finden Sie ab Seite / Prices are indicated on page 184



■ Rampenprofile / Ramp Profiles

Artikel
article

Farbe
colour

Länge
length

Version
version

261 EC

90° Ecke für Typ 261 U,
mit Verbindern, ungebohrt,
ohne Dichtlippe
90° corner for type 261 U,
with connectors, undrilled,
without sealing lips

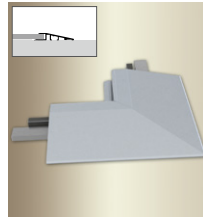
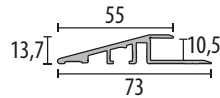

F4	0,2 m x 0,2 m	SBS •	U/EC •
----	---------------------	----------	-----------

263 U

ungebohrt, mit Verbindern
undrilled, with connectors

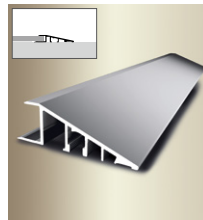
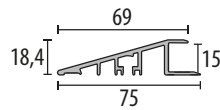

F4	3,0 m	SBS •	U •
----	-------	----------	--------

263 EC

90° Ecke für Typ 263 U,
mit Verbindern, ungebohrt,
ohne Dichtlippe
90° corner for type 263 U,
with connectors, undrilled,
without sealing lips

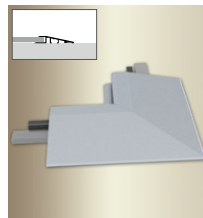
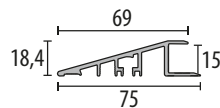

F4	0,2 m x 0,2 m	SBS •	U/EC •
----	---------------------	----------	-----------

267 U

ungebohrt, mit Verbindern
undrilled, with connectors

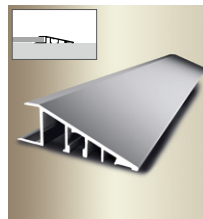
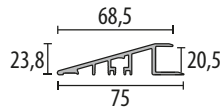

F4	3,0 m	SBS •	U •
----	-------	----------	--------

267 EC

90° Ecke für Typ 267 U,
mit Verbindern, ungebohrt
90° corner for type 267 U,
with connectors, undrilled

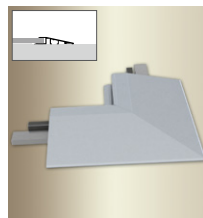
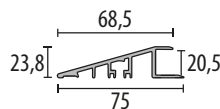

F4	0,2 m x 0,2 m	SBS •	U/EC •
----	---------------------	----------	-----------

266 U

ungebohrt, mit Verbindern,
mit Dichtlippe
undrilled, with connectors,
with sealing lips

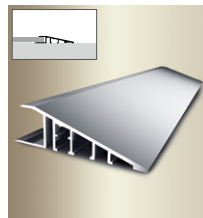
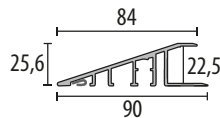

F4	3,15 m	SBS •	U •
----	--------	----------	--------

266 EC

90° Ecke für Typ 266 U,
mit Verbindern, ungebohrt,
mit Dichtlippe
90° corner for type 266 U,
with connectors, undrilled,
with sealing lips

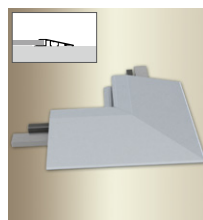
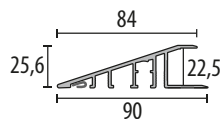

F4	0,2 m x 0,2 m	SBS •	U/EC •
----	---------------------	----------	-----------

Preise finden Sie ab Seite / Prices are indicated on page 184



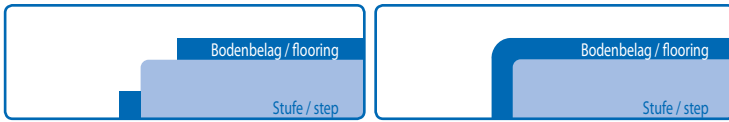

Treppenkanten- und Winkelprofile

Stair Nosings and Angle Edges



Best-Profile

- Treppenkanten- und Winkelprofile / Stair Nosings and Angle Edges

Mit *Küberit* Treppenkanten- und Winkelprofilen verfügen Sie über unterschiedliche Profillösungen für die professionelle Renovierung von Treppen, die einfach und zeitsparend für die verschiedensten Bodenbeläge und -stärken ausgelegt sind und dennoch dekorativ wirken. Safety first, hohe Qualität und komfortabel zu verarbeiten – das sind die besonderen Eigenschaften der *Küberit* Treppenkantenprofile.

With *Küberit* stair nosing and angle profiles you have different profile solutions for the professional renovation of stairs, which are easy and time-saving for different floor coverings and thicknesses and still look decorative. Safety first, high quality and comfortable to process – these are the special characteristics of the *Küberit* stair nosing profiles.

Winkelprofile / Angle Edges

Artikel
article

236

versenkt gebohrt oder
selbstklebend, mit Zierrillen
countersunk drilled or
self-adhesive, fluted
EB = \varnothing min 70 cm

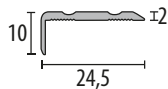

Farbe
colour

Länge
length

Version
version

Farbe	Länge	Version
F1G*	0,9 m	SBS V SK H/SK
F2	1,0 m	• • • •
F3	2,5 m	• • • •
F4	2,7 m	• • • •
F4G*	3,0 m	• • • •
F5	5,0 m	• • • •
F6		
F9		
H20		
H22		
H30		
H31		
H33		
H34		
H40		
H61		
H62		
H63		
H64		
H65		
H80		
H81		
H95		
RAL9016		
RAL9005		
F15		
F16		
	0,9 m	RAL/SK 9016
	1,0 m	RAL/SK 9005
	2,7 m	• •
	3,0 m	• •
	5,0 m	• •
		* nur für/only for 1,0 m & 3,0 m

235

versenkt gebohrt oder
selbstklebend, mit Zierrillen
countersunk drilled or
self-adhesive, fluted
EB = \varnothing min 150 cm

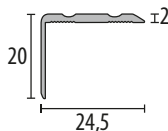

Farbe	Länge	Version
F1G*	0,9 m	SBS V SK H/SK
F2	1,0 m	• • • •
F3	2,5 m	• • • •
F4	2,7 m	• • • •
F4G*	3,0 m	• • • •
F5	5,0 m	• • • •
F6		
F9		
H20		
H22		
H30		
H31		
H33		
H34		
H40		
H61		
H62		
H63		
H64		
H65		
H80		
H81		
H95		
RAL9016		
RAL9005		
F15		
F16		
	1,0 m	RAL/SK 9016
	2,7 m	RAL/SK 9005
	3,0 m	• •
	5,0 m	• •
		* nur für/only for 1,0 m & 3,0 m

237

versenkt gebohrt oder
selbstklebend, mit Zierrillen
countersunk drilled or
self-adhesive, fluted
EB = \varnothing min 120 cm

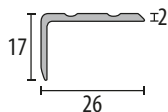

Farbe	Länge	Version
F1G**	0,9 m	SBS RAL/SK V/SK
F2	1,0 m	• • • •
F4	2,5 m	• • • •
F4G**	2,7 m	• • • •
F5	3,0 m	• • • •
F6	5,0 m	• • • •
F9		
RAL9005		
F16		
		* nur für/only for F2, F4 & F9 SK
		** nur für/only for 1,0 m & 3,0 m

234 SK

selbstklebend (2x), mit Zierrillen
self-adhesive (2x), fluted

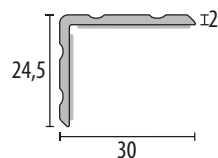

Farbe	Länge	Version
F2	1,0 m	SBS RAL/SK SK
F4	2,5 m	• • • •
F5	2,7 m	• • • •
F6	3,0 m*	• • • •
F9	5,0 m	• • • •
RAL9005		
F16		
		* nicht für/not for F5
		** nicht für/not for F5 & F6

236

versenkt gebohrt,
mit Zierrillen
countersunk drilled, fluted

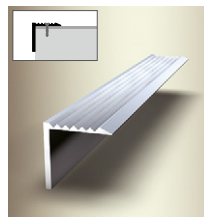
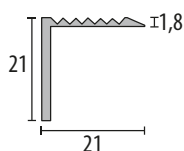

Farbe	Länge	Version
F2	1,0 m	SBS V
F3	2,5 m	• •
F4	5,0 m	• •
F5		
F6		
F7		
F9		

Preise finden Sie ab Seite / Prices are indicated on page 184

Winkelprofile / Angle Edges

Artikel article

227

versenkt gebohrt,
mit Zierrillen
countersunk drilled, fluted

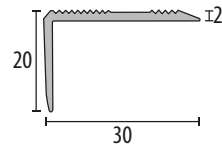

Farbe colour

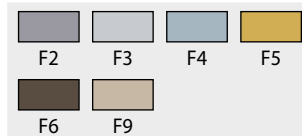

Länge length

2,5 m
5,0 m

Version version

SBS
•
•

V
•
•



226

versenkt gebohrt,
mit Zierrillen
countersunk drilled, fluted

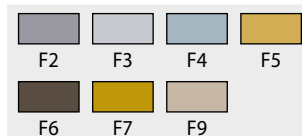
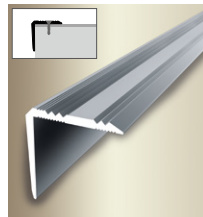
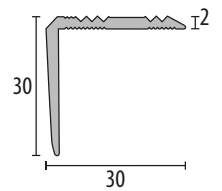

2,5 m
5,0 m

SBS
•
•

V
•
•

V8

R10



Preise finden Sie ab Seite / Prices are indicated on page **186**



© Küberit®

236

Winkelprofile / Angle Edges

Artikel
article

Farbe
colour

Länge
length

Version
version

225

versenkt gebohrt,
mit Zierrillen
countersunk drilled, fluted

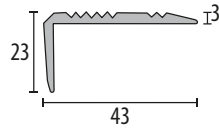

				1,0 m 2,5 m 3,0 m 5,0 m	SBS • • • •	V • • •*		

228

versenkt gebohrt,
mit Zierrillen
countersunk drilled, fluted

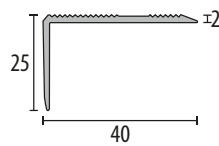

				1,0 m 2,5 m 3,0 m 5,0 m	SBS • • • •	V • • •		

229

versenkt gebohrt,
mit Zierrillen
countersunk drilled, fluted

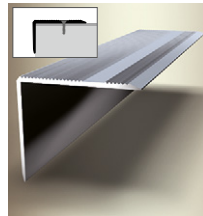
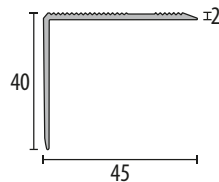

				1,0 m 2,5 m 3,0 m 5,0 m	SBS • • • •	V • • •		

Preise finden Sie ab Seite / Prices are indicated on page 186



225

© Klibert®

Winkelprofile / Angle Edges

Artikel
article

Farbe
colour

Länge
length

Version
version

530

versenkt gebohrt,
mit Zierrillen
countersunk drilled, fluted

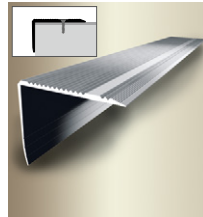
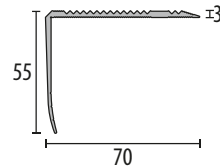

				1,0 m 2,5 m 5,0 m	SBS • • •	V •* • •			
					* nur für/only for F2, F4 & F9				

535

versenkt gebohrt,
mit Zierrillen
countersunk drilled, fluted

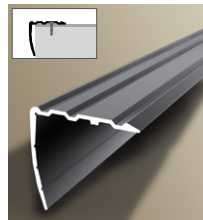
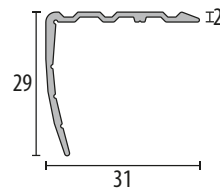

				1,0 m 2,5 m 3,0 m 5,0 m	SBS • • • •	V • • • •			

540

versenkt gebohrt,
mit Zierrillen
countersunk drilled, fluted

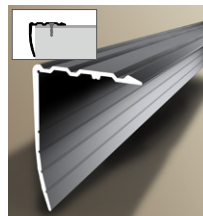
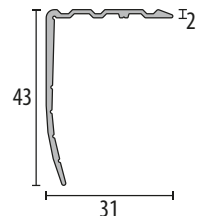

				1,0 m 2,5 m 3,0 m 5,0 m	SBS • • • •	V • • • •			

Preise finden Sie ab Seite / Prices are indicated on page 187

Zubehör / Accessories

Reparaturwinkel / Stair-repairing Angles

RW 20

verzinktes Eisen, mit 20 mm Nase
für Holzstufen mittlerer Abnutzung
galvanized iron, nose of 20 mm for
wooden steps with medium abrasion

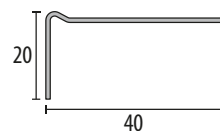

1 Karton / carton = 50 x 1 m
inkl. 500 Schraubnägel / screw nails

Schraubnägel, verzinkt
screw nails, galvanized
2,4 x 25 mm

1 Beutel / bag

RW 38

verzinktes Eisen, mit 38 mm Nase
für Holzstufen stärkerer Abnutzung
galvanized iron, nose of 38 mm for
wooden steps with high abrasion

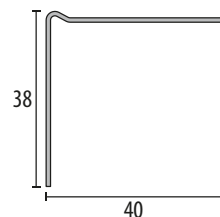

1 Karton / carton = 25 x 1 m
inkl. 250 Schraubnägel / screw nails



RW S

verzinktes Eisen, mit 20 mm Nase
für abgenutzte Steinstufen
galvanized iron, nose of 20 mm
for worn-down stone steps

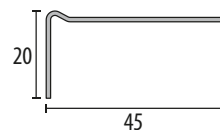

1 Karton / carton = 30 x 1 m
inkl. 200 Senkkopf-Torx-Schrauben
und 200 Dübel
incl. 200 torx screws with
countersunk head and 200 anchors

Nylon Dübel / Nylon anchors
6 x 30 mm
(1 Beutel / bag = 200 St. / pcs.)

Senkkopf-Torx-Schrauben,
gehärtet / torx screws, hardened,
4,0 x 30 mm
(1 Karton / carton = 200 St. / pcs.)

Preise finden Sie ab Seite / Prices are indicated on page 187

Winkelprofile / Angle Edges

Artikel
article

Farbe
colour

Länge
length

Version
version

238 U

ungebohrt
undrilled
EB = \varnothing min 100 cm

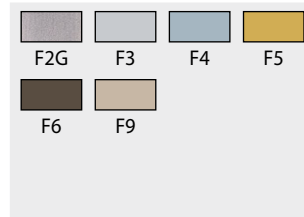
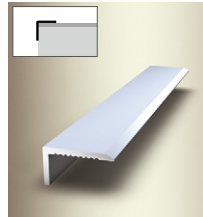
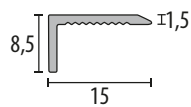

2,7 m	SBS •	U •		
-------	----------	--------	--	--

277 U

ungebohrt
undrilled
EB = \varnothing min 120 cm

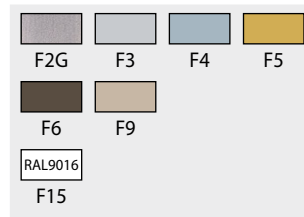
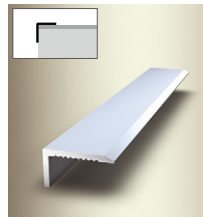
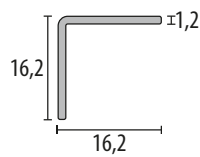

2,5 m 5,0 m	SBS • •	U • •		
----------------	---------------	-------------	--	--

278 U

ungebohrt
undrilled
EB = \varnothing min 120 cm

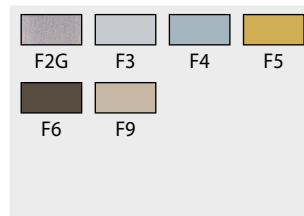
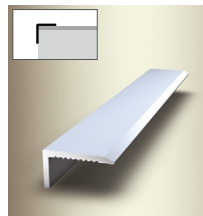
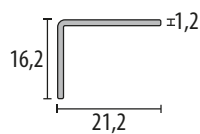

2,5 m 5,0 m	SBS • •	U • •		
----------------	---------------	-------------	--	--

279 U

ungebohrt
undrilled

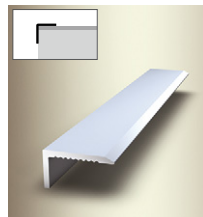
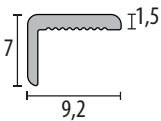

3,05 m	SBS •	U •		
--------	----------	--------	--	--

401 U

ungebohrt
undrilled
EB = \varnothing min 100 cm

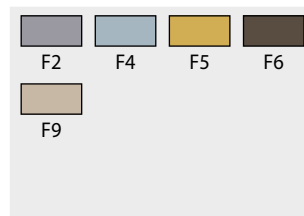
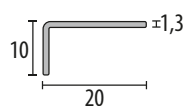

1,0 m 3,0 m	SBS • •	U • •		
----------------	---------------	-------------	--	--

544 U

ungebohrt,
1-fach gekantet
Crossline geschliffen
undrilled, 1-side edged
Crossline grinded

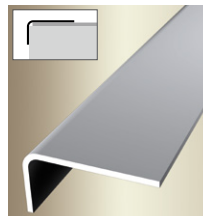
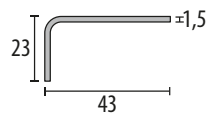

2,5 m	SBS •	U •		
-------	----------	--------	--	--

545 U

ungebohrt
1-fach gekantet
undrilled, 1-side edged

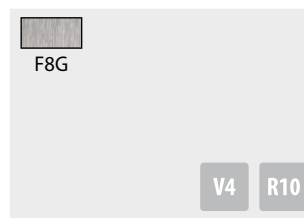
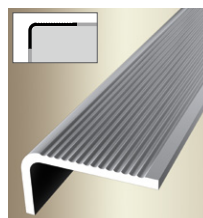
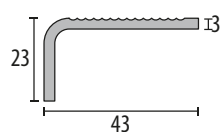

2,5 m	SBS •	U •		
-------	----------	--------	--	--

Preise finden Sie ab Seite / Prices are indicated on page 187

■ Winkelprofile / Angle Edges



© Küberit®

544, 917, 142

■ Sicherheitstreppenkantenprofile / Safety Stair Nosings

Artikel
article

706

versenkt gebohrt, (A) Normal- oder (C) Doppelverschraubung, für auswechselbare PVC-Einlagen
countersunk drilled, (A) standard or (C) double drilling, for exchangeable PVC inserts

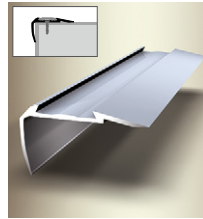
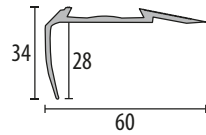

Farbe
colour

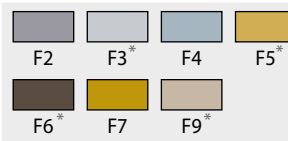

* nur Normalverschraubung (A)
only standard drilling (A)

Länge
length

2,5 m
5,0 m



Version
version

SBS
•
•
A
•
•
C
•
•



708 N

versenkt gebohrt, für auswechselbare PVC-Einlagen
countersunk drilled, for exchangeable PVC inserts

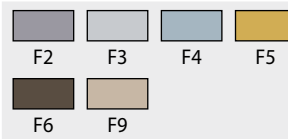
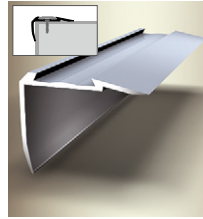
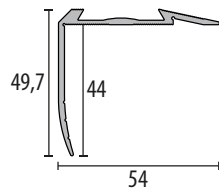

2,5 m
5,0 m



SBS
•
•
N
•
•



707

versenkt gebohrt, (A) Normal- oder (C) Doppelverschraubung, für auswechselbare PVC-Einlagen
countersunk drilled, (A) standard or (C) double drilling, for exchangeable PVC inserts

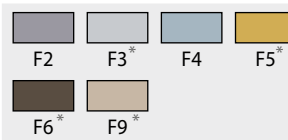
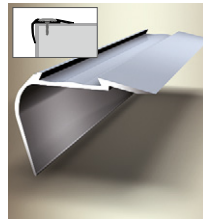
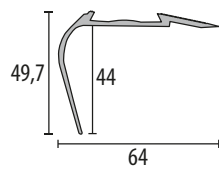

2,5 m
5,0 m



SBS
•
•
A
•
•
C
•
•



Preise finden Sie ab Seite / Prices are indicated on page 188



■ Sicherheitstreppenkantenprofile / Safety Stair Nosings

Artikel
article

Farbe
colour

Länge
length

Version
version

700

versenkt gebohrt, für auswechselbare PVC-Einlagen
countersunk drilled, for exchangeable PVC inserts

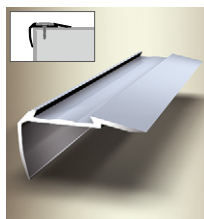
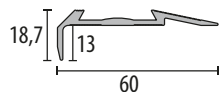

	2,5 m	SBS	V
	5,0 m	•	•

701

versenkt gebohrt, für auswechselbare PVC-Einlagen
countersunk drilled, for exchangeable PVC inserts

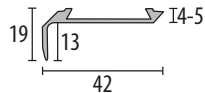

	2,5 m	SBS	V
	5,0 m	•	•

702

versenkt gebohrt, für auswechselbare PVC-Einlagen
countersunk drilled, for exchangeable PVC inserts

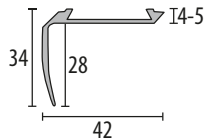

	2,5 m	SBS	V
	5,0 m	•	•

Preise finden Sie ab Seite / Prices are indicated on page 188

Zubehör / Accessories

PVC-Einlagen für Sicherheits-Treppenkantenprofile
PVC Inserts for Safety Stair Nosings

Artikel
article

Farbe
colour

Länge
length

2504

PVC-Einlagen gerillt
PVC inserts grooved

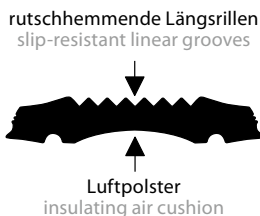

	1 Rolle / roll
	25 m

2505

PVC-Einlagen glatt
PVC inserts plain



	1 Rolle / roll
	25 m

Toleranz 0,3 mm / F200 Toleranz 0,2 mm

Preise finden Sie ab Seite / Prices are indicated on page 189

■ Sicherheitstreppenkantenprofile / Safety Stair Nosings

Artikel
article

Farbe
colour

Länge
length

Version
version

705

versenkt gebohrt, für auswechselbare PVC-Einlagen
countersunk drilled, for exchangeable PVC inserts

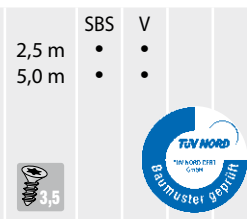
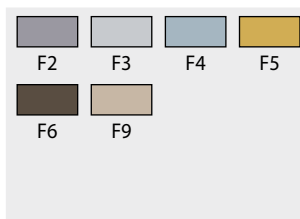
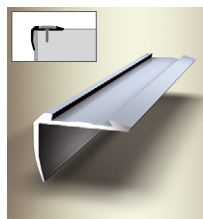
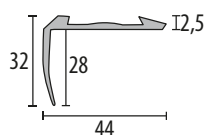

709

versenkt gebohrt, für auswechselbare PVC-Einlagen
countersunk drilled, for exchangeable PVC inserts

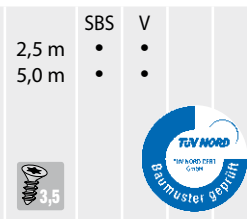
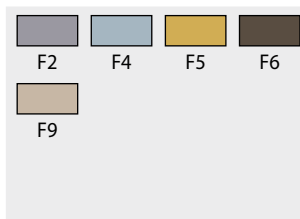
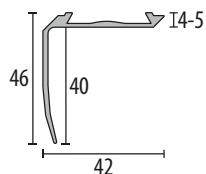

703

versenkt gebohrt, für auswechselbare PVC-Einlagen
countersunk drilled, for exchangeable PVC inserts

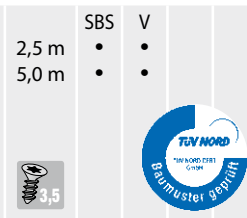
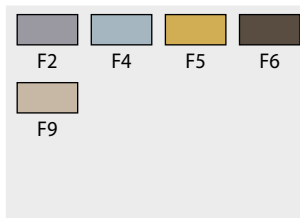
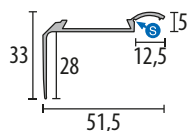

704

versenkt gebohrt, für auswechselbare PVC-Einlagen (2x)
countersunk drilled, for exchangeable PVC inserts (2x)

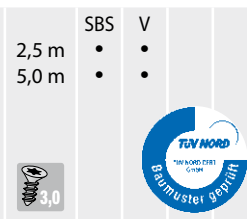
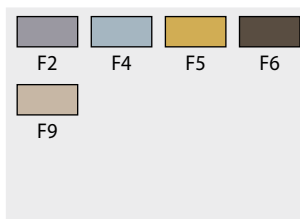
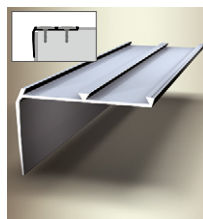
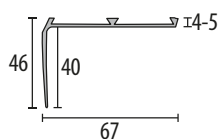

Preise finden Sie ab Seite / Prices are indicated on page 188

■ Treppenkantenprofile »RENO-TK« / Stair Nosings »RENO-TK«

711

versenkt gebohrt,
ohne Gleitschutzeinlage,
für Teppichböden nicht geeignet
countersunk drilled,
without slip-resistant insert,
not suitable for carpet flooring

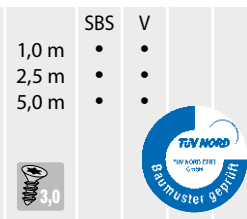
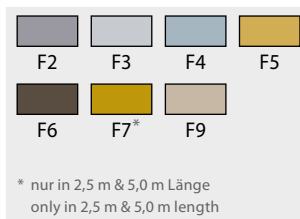
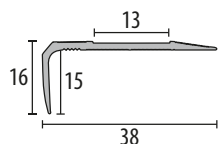

712

versenkt gebohrt,
ohne Gleitschutzeinlage,
für Teppichböden nicht geeignet
countersunk drilled,
without slip-resistant insert,
not suitable for carpet flooring

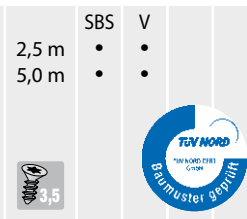
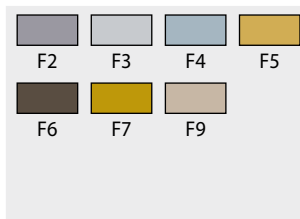
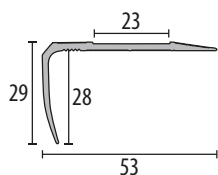

Preise finden Sie ab Seite / Prices are indicated on page 188

■ Treppenkantenprofile »RENO-TK« / Stair Nosings »RENO-TK«

Artikel
article

Farbe
colour

Länge
length

Version
version

715

versenkt gebohrt,
ohne Gleitschutzeinlage,
für Teppichböden nicht geeignet
countersunk drilled,
without slip-resistant insert,
not suitable for carpet flooring

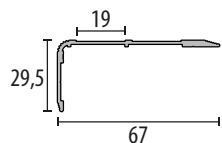

	3,0 m	SBS •	V •

713

versenkt gebohrt, für 2x Einlagen
ohne Gleitschutzeinlagen,
für Teppichböden nicht geeignet
countersunk drilled, for 2x Inserts
without slip-resistant inserts,
not suitable for carpet flooring

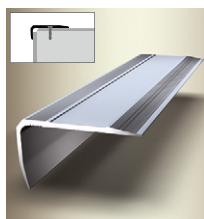
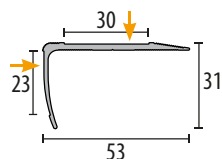

	3,0 m	SBS •	V •

Preise finden Sie ab Seite / Prices are indicated on page 189



Zubehör / Accessories

Artikel
article

Farbe
colour

Länge
length

2510/13+23 (X=13+23 mm)

Gleitschutzeinlage
selbstklebend
slip-resistant insert
self-adhesive

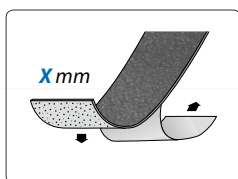

2511/13+19+23+30 (X=13+19*+23+30* mm)

Mineral-Gleitschutzeinlage mit höchstmöglich
rutschhemmender Wirkung! Mit grobkörniger Oberfläche
Rutschsicherheit R13 (DIN 51130), selbstklebend
Mineral slip-resistant insert with maximum non-skid effect!
with coarse-grained surface –slip resistance R13 (DIN 51130), self-adhesive

2512/13+23 (X=13+23 mm)

Rutschsicherheit R9 (DIN 51130),
selbstklebend
slip resistance R9 (DIN 51130),
self-adhesive

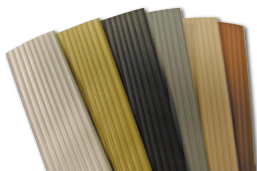

<p>Gleitschutzeinlage ohne Körnung slip-resistant insert without granulation</p> <p>Toleranz 0,2 mm</p>	1 Rolle / roll 25 m	SK •
<p>Gleitschutzeinlage mit Körnung slip-resistant insert with granulation</p> <p>Toleranz 0,1 mm</p> <p>R13</p>	25 m 18 m	• •*
<p>Gleitschutzeinlage mit PVC slip-resistant insert with PVC</p> <p>Toleranz 0,3 mm</p> <p>R9</p>	25 m	•

* nicht in allen Farben erhältlich / not available in all colours

Preise finden Sie ab Seite / Prices are indicated on page 189

Treppenkantenprofile / Stair Nosings

Artikel
article

Farbe
colour

Länge
length

Version
version

809

versenkt gebohrt,
mit Zierrillen
countersunk drilled,
fluted

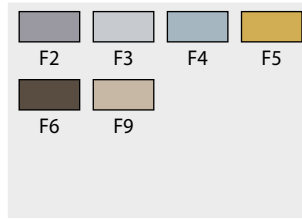
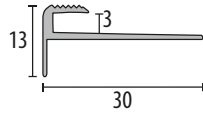

1,0 m	SBS	V		
2,5 m	•	•		
5,0 m	•	•		

807

versenkt gebohrt,
mit Zierrillen
countersunk drilled,
fluted

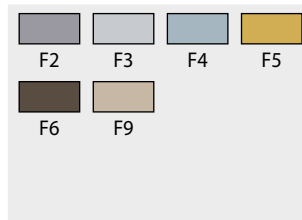
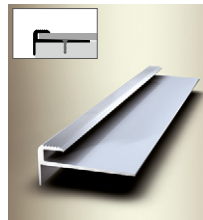
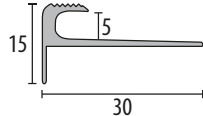

1,0 m	SBS	V		
2,5 m	•	•		
5,0 m	•	•		

808

versenkt gebohrt,
mit Zierrillen
countersunk drilled,
fluted

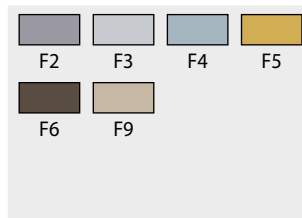
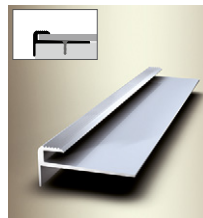
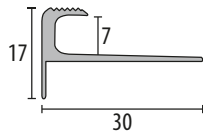

1,0 m	SBS	V		
2,5 m	•	•		
5,0 m	•	•		

810

versenkt gebohrt,
mit Zierrillen
countersunk drilled,
fluted

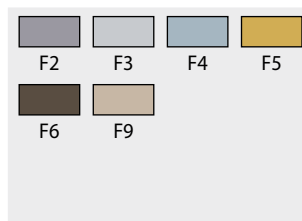
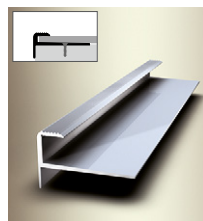
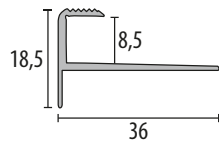

1,0 m	SBS	V		
2,5 m	•	•		
5,0 m	•	•		

811

versenkt gebohrt,
mit Zierrillen
countersunk drilled,
fluted

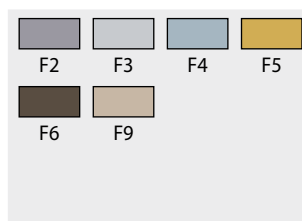
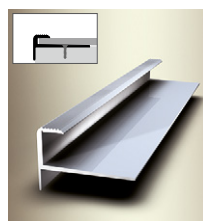
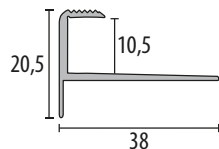

1,0 m	SBS	V		
2,5 m	•	•		
5,0 m	•	•		

812

versenkt gebohrt,
mit Zierrillen
countersunk drilled,
fluted

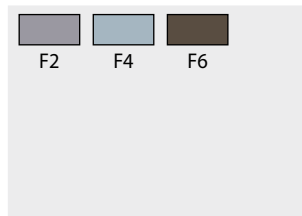
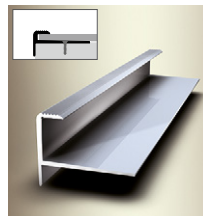
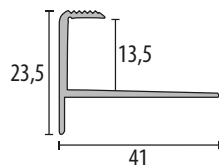

1,0 m	SBS	V		
2,5 m	•	•		
5,0 m	•	•		

813

versenkt gebohrt,
mit Zierrillen
countersunk drilled,
fluted

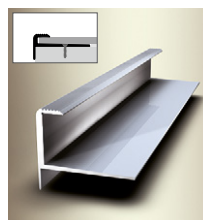
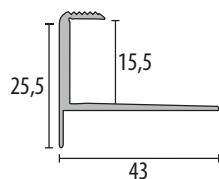

1,0 m	SBS	V		
2,5 m	•	•		
5,0 m	•	•		

Preise finden Sie ab Seite / Prices are indicated on page 189

■ Treppenkantenprofile / Stair Nosings

Artikel article

826

doppelt versenkt gebohrt,
mit Zierrillen
double countersunk drilled,
fluted

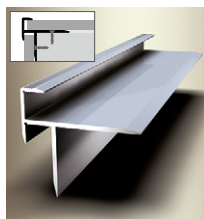
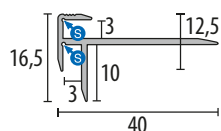

Farbe colour



Länge length

2,5 m
5,0 m

Version version

SBS	V
•	•
•	•



828

doppelt versenkt gebohrt,
mit Zierrillen
double countersunk drilled,
fluted

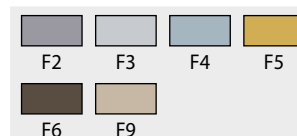
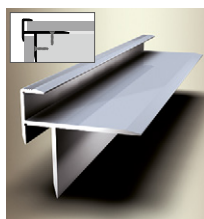
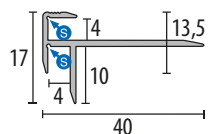

2,5 m
5,0 m

SBS	V
•	•
•	•



830

doppelt versenkt gebohrt,
mit Zierrillen
double countersunk drilled,
fluted

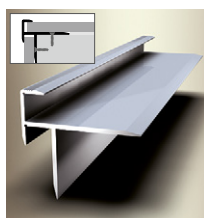
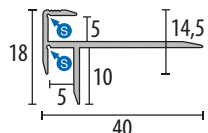

2,5 m
5,0 m

SBS	V
•	•
•	•



209

doppelt versenkt gebohrt,
mit Zierrillen
double countersunk drilled,
fluted

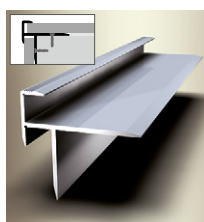
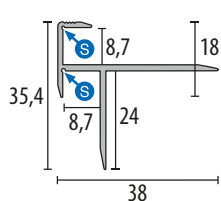

1,0 m
2,7 m
3,0 m

SBS	V
•	•
•	•
•	•



208

doppelt versenkt gebohrt,
mit Zierrillen
double countersunk drilled,
fluted

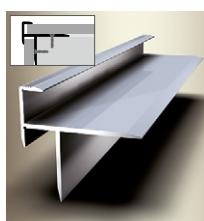
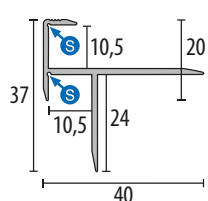

1,0 m
3,0 m

SBS	V
•	•
•	•



207

doppelt versenkt gebohrt,
mit Zierrillen
double countersunk drilled,
fluted

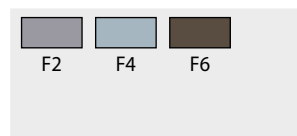
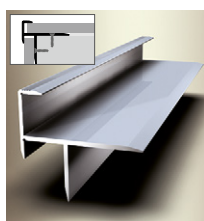
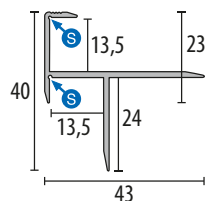

1,0 m
3,0 m

SBS	V
•	•
•	•



206

doppelt versenkt gebohrt,
mit Zierrillen
double countersunk drilled,
fluted

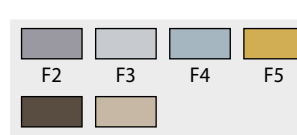
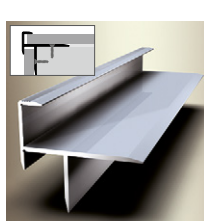
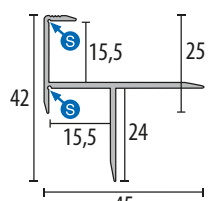

1,0 m
3,0 m

SBS	V
•	•
•	•



Preise finden Sie ab Seite / Prices are indicated on page 190

Treppenkantenprofile / Stair Nosings

Artikel
article

Farbe
colour

Länge
length

Version
version

832

doppelt versenkt gebohrt,
mit Zierrillen
double countersunk drilled,
fluted

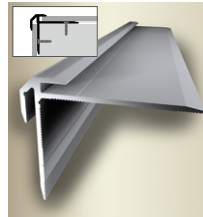
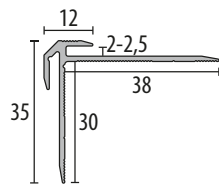

F2	F3	F4	F5	2,5 m 5,0 m	SBS • •	V • •		
F6	F9							

835

doppelt versenkt gebohrt,
mit Zierrillen
double countersunk drilled,
fluted

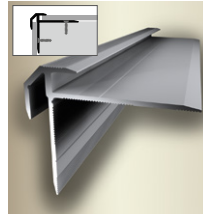
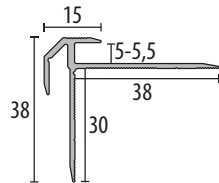

F2	F3	F4	F5	2,5 m 5,0 m	SBS • •	V • •		
F6	F9							

838

doppelt versenkt gebohrt,
mit Zierrillen
double countersunk drilled,
fluted

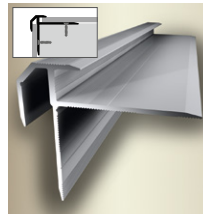
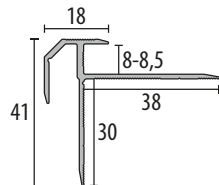

F2	F3	F4	F5	2,5 m 5,0 m	SBS • •	V • •		
F6	F9							

Preise finden Sie ab Seite / Prices are indicated on page 190

Treppenkantenprofile »DEKO-TK« / Stair Nosings »DEKO-TK«

855

versenkt gebohrt
countersunk drilled

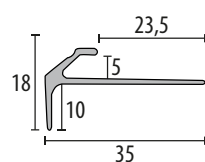

F2	F3	F4	F5	2,5 m 5,0 m	SBS • •	V • •		
F6	F7	F9						

850

versenkt gebohrt
countersunk drilled

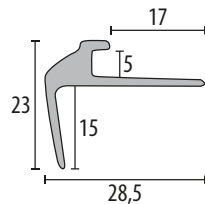

F2	F3	F4	F5	2,5 m 5,0 m	SBS • •	V • •		
F6	F7	F9						

852

versenkt gebohrt
countersunk drilled

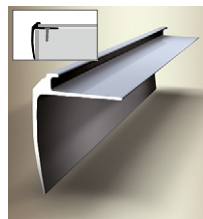
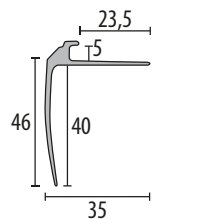

F2	F3	F4	F5	2,5 m 5,0 m	SBS • •	V • •		
F6	F9							

Preise finden Sie ab Seite / Prices are indicated on page 190

■ Treppenkantenprofile »DEKO-TK« / Stair Nosings »DEKO-TK«

Artikel
article

857

versenkt gebohrt
countersunk drilled

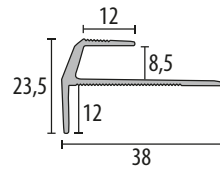

Farbe
colour

Länge
length

Version
version

				2,5 m 5,0 m	SBS • •	V • •
				3,0		

Preise finden Sie ab Seite / Prices are indicated on page **191**



© Küberit®

Treppenkanten- und Winkelprofile

Stair Nosings and Angle Edges

Treppenkantenprofile für LVT-, CV- oder PVC-Böden / Stair Nosings for LVT-, CV- or PVC-flooring

Artikel
article

Farbe
colour

Länge
length

Version
version

845
versenkt gebohrt
countersunk drilled

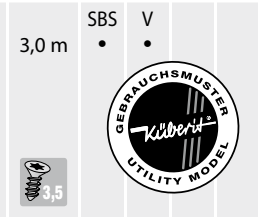
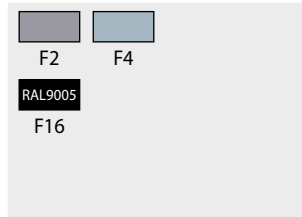
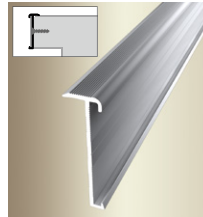
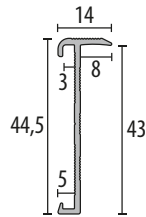

846
versenkt gebohrt
countersunk drilled

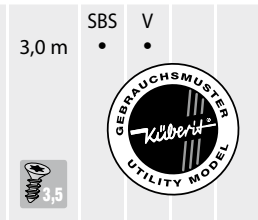
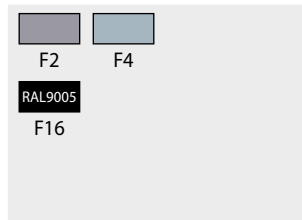
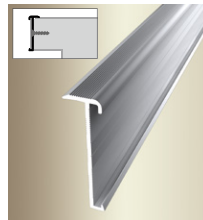
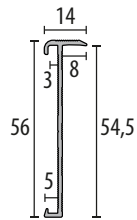

844
versenkt gebohrt
countersunk drilled

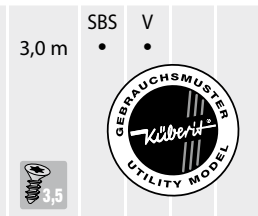
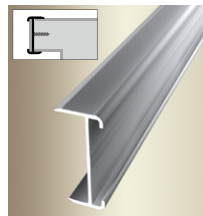
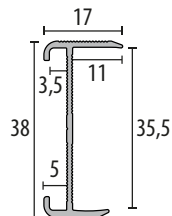

844 WS
versenkt gebohrt, 2-teilig,
Wasserstrahlgeschnitten,
Höhenverstellbar ab 35,5 mm
countersunk drilled, 2-part,
water jet cut, adjustable
height from 35,5 mm

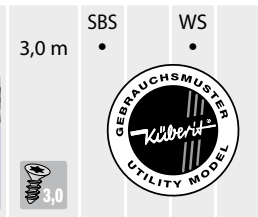
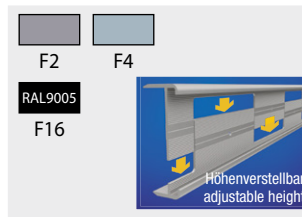
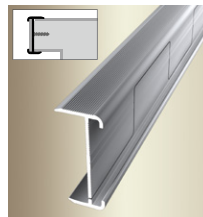
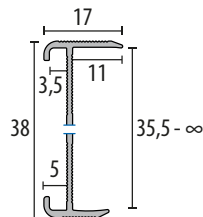

847
versenkt gebohrt
countersunk drilled

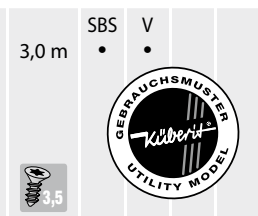
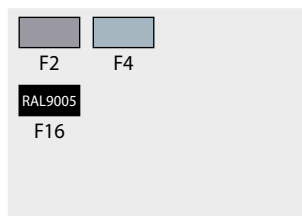
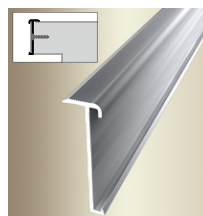
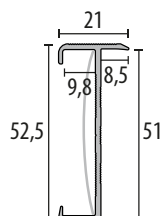

Preise finden Sie ab Seite / Prices are indicated on page 191

Zubehör / Accessories

Artikel
article

Farbe
colour

Version
version



847 AE / 845 AE

847 ER / 845 ER

847 EL / 845 EL

Außencke
external corner

Endstück rechts
end cap right

Endstück links
end cap left

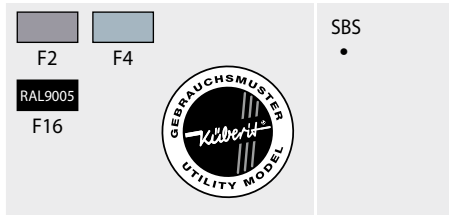

Preise finden Sie ab Seite / Prices are indicated on page 191

Runde Ecken für Treppenkanten finde Sie auf Seite / Rounded Edges for stair Nosings are indicated on page 61

- Treppenkantenprofile für LVT-, CV- oder PVC-Böden / Stair Nosings for LVT-, CV- or PVC-flooring



VIDEO



kueberit.com/qr/847

© Küberit®

■ Treppenkantenprofile für LVT-, CV- oder PVC-Böden / Stair Nosings for LVT-, CV- or PVC-flooring

Artikel
article

Farbe
colour

Länge
length

Version
version

859

versenkt gebohrt,
mit Kleberillen
countersunk drilled,
fluted for glueing

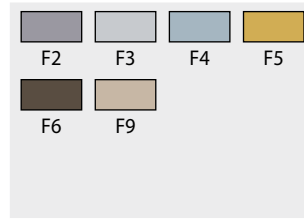
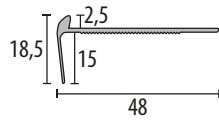

1,0 m	SBS	V
2,5 m	•	•*
5,0 m	•	•
	•	•

3,0 * nur für/only for F2 & F4

860

versenkt gebohrt,
mit Kleberillen
countersunk drilled,
fluted for glueing

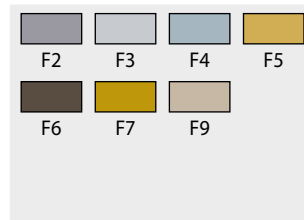
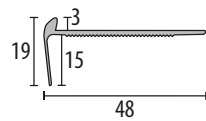

1,0 m	SBS	V
2,5 m	•	•*
5,0 m	•	•
	•	•

3,0 * nur für/only for F2 & F4

862

versenkt gebohrt,
mit Kleberillen
countersunk drilled,
fluted for glueing

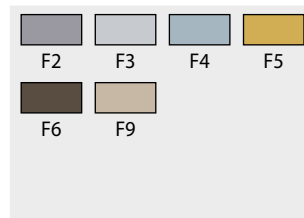
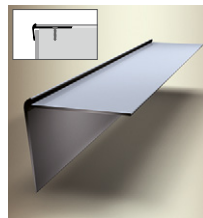
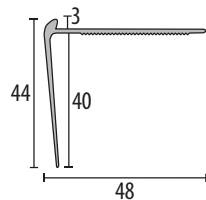

1,0 m	SBS	V
2,5 m	•	•*
5,0 m	•	•
	•	•

3,0 * nur für/only for F2 & F4

861

versenkt gebohrt,
mit Kleberillen
countersunk drilled,
fluted for glueing

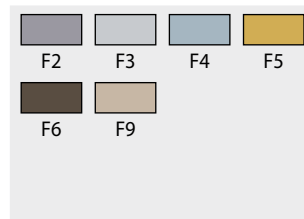
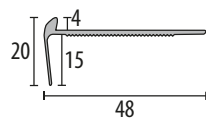

2,5 m	SBS	V
5,0 m	•	•
	•	•

3,0

Preise finden Sie ab Seite / Prices are indicated on page 191



© Kübert®

Runde Ecken für Treppenkanten finde Sie auf Seite / Rounded Edges for stair Nosings are indicated on page 58-59

■ Treppenkantenprofile für LVT-, CV- oder PVC-Böden / Stair Nosings for LVT-, CV- or PVC-flooring

Artikel
article

Farbe
colour

Länge
length

Version
version

863

versenkt gebohrt,
mit Kleberillen
countersunk drilled,
fluted for glueing

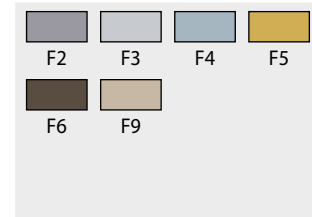
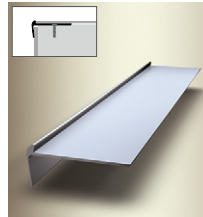
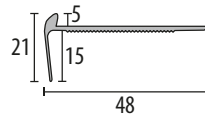

2,5 m	SBS	V		
5,0 m	•	•		
	•	•		

864

versenkt gebohrt,
mit Kleberillen
countersunk drilled,
fluted for glueing

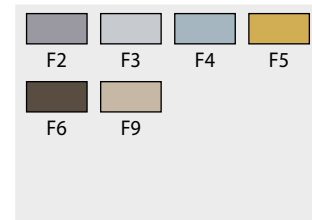
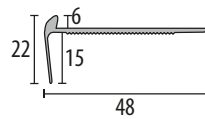

2,5 m	SBS	V		
5,0 m	•	•		
	•	•		

865

versenkt gebohrt,
mit Kleberillen
countersunk drilled,
fluted for glueing

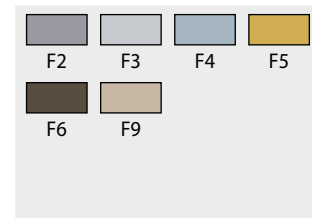
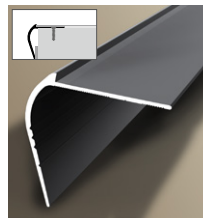
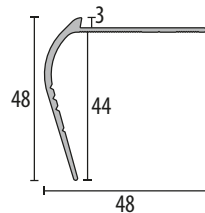

2,5 m	SBS	V		
5,0 m	•	•		
	•	•		

866

versenkt gebohrt,
mit Kleberillen
countersunk drilled,
fluted for glueing

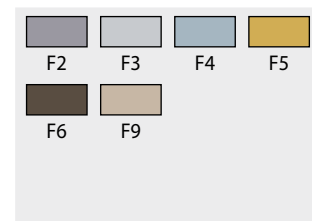
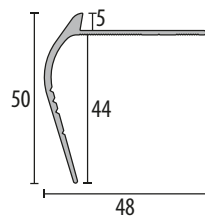

2,5 m	SBS	V		
5,0 m	•	•		
	•	•		

Preise finden Sie ab Seite / Prices are indicated on page 191



■ Treppenkantenprofile für LVT-, CV-, PVC- oder Korkböden / Stair Nosings for LVT-, CV-, PVC or Cork Flooring

Artikel
article

Farbe
colour

Länge
length

Version
version

870

*doppelt versenkt gebohrt,
mit Kleberillen*
*double countersunk drilled,
fluted for glueing*

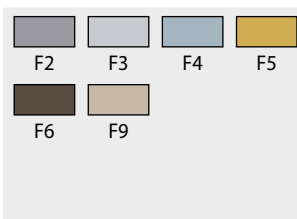
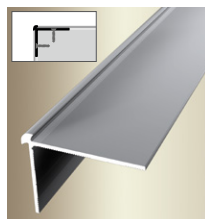
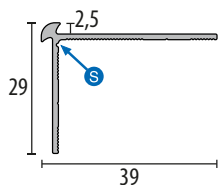

1,0 m	SBS	V
2,5 m	•	•*
5,0 m	•	•

3,0

* nur für/only for F2 & F4

871

*doppelt versenkt gebohrt,
mit Kleberillen*
*double countersunk drilled,
fluted for glueing*

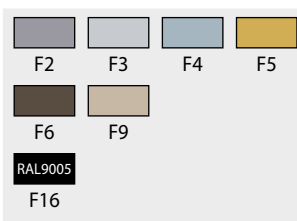
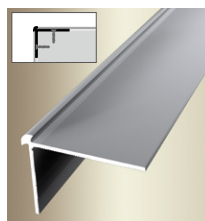
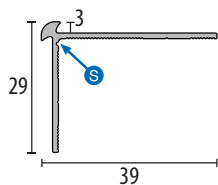

1,0 m	SBS	V
2,5 m	•	•*
5,0 m	•	•

3,0

* nur für/only for F2 & F4

872

*doppelt versenkt gebohrt,
mit Kleberillen*
*double countersunk drilled,
fluted for glueing*

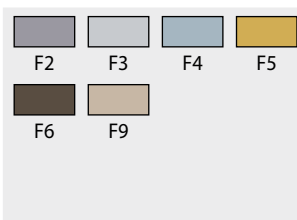
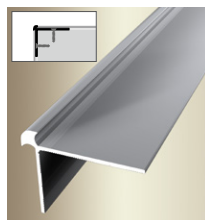
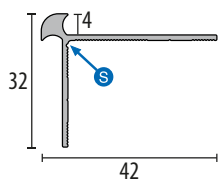

2,5 m	SBS	V
5,0 m	•	•

3,0

873

*doppelt versenkt gebohrt,
mit Kleberillen*
*double countersunk drilled,
fluted for glueing*

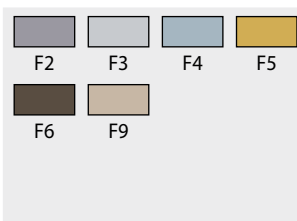
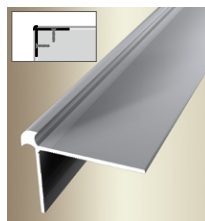
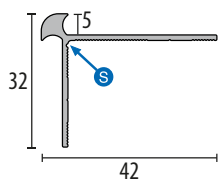

1,0 m	SBS	V
2,5 m	•	•*
5,0 m	•	•

3,0

* nur für/only for F2 & F4

874

*doppelt versenkt gebohrt,
mit Kleberillen*
*double countersunk drilled,
fluted for glueing*

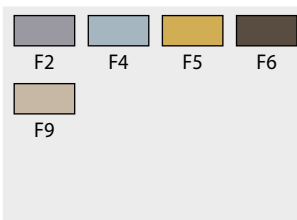
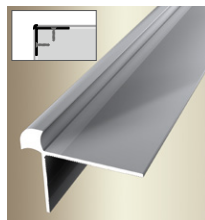
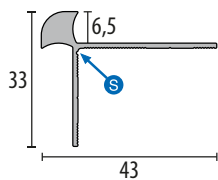

1,0 m	SBS	V
2,5 m	•	•*
5,0 m	•	•

3,0

* nur für/only for F2 & F4

875

*doppelt versenkt gebohrt,
mit Kleberillen*
*double countersunk drilled,
fluted for glueing*

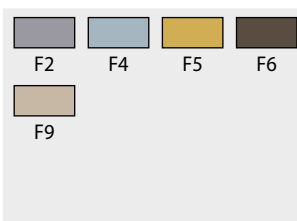
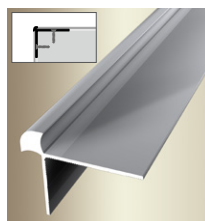
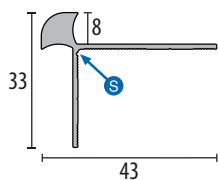

2,5 m	SBS	V
5,0 m	•	•

3,0

Preise finden Sie ab Seite / Prices are indicated on page 192

Sollbiegestelle
Predetermined bending point

Runde Ecken für Treppenkanten finde Sie auf Seite / Rounded Edges for stair Nosings are indicated on page 60

■ Treppen-Innenwinkel für LVT-, CV- oder PVC-Böden / Internal Angle for LVT-, CV- or PVC-flooring

Artikel article

Farbe colour

Länge length

Version version

870 IW

doppelt versenkt gebohrt,
mit Kleberillen
double countersunk drilled,
fluted for glueing

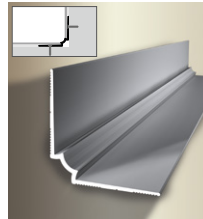
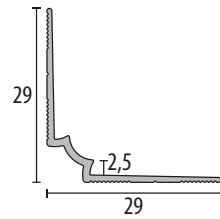

F2	F4	F5	F6
F9			

2,5 m	SBS	V		
5,0 m	•	•		
	•	•		
	3,0			

871 IW

doppelt versenkt gebohrt,
mit Kleberillen
double countersunk drilled,
fluted for glueing

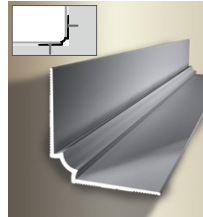
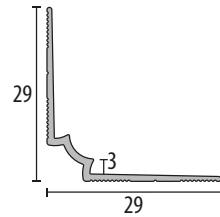

F2	F4	F5	F6
F9			

2,5 m	SBS	V		
5,0 m	•	•		
	•	•		
	3,0			

877 IW

doppelt versenkt gebohrt,
mit Kleberillen
double countersunk drilled,
fluted for glueing

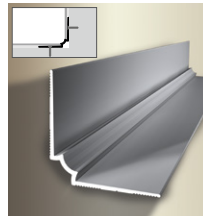
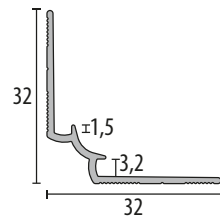

F2	F4

2,5 m	SBS	V		
5,0 m	•	•		
	•	•		
	3,0			

Preise finden Sie ab Seite / Prices are indicated on page 192



871, 871 IW, 912

© Küberit®

- TK-Profile mit runden Ecken für LVT-, CV- oder PVC-Böden / Stair Nosings with Rounded Edges for LVT-, CV- or PVC-flooring

Artikel
article

Farbe
colour

Länge
length

Version
version

859 EC

versenkt gebohrt,
mit Kleberillen
countersunk drilled,
fluted for glueing

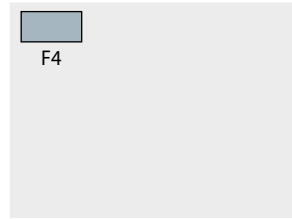
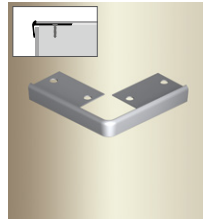
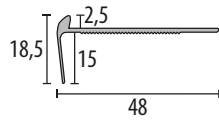

SBS	EC
•	•

859 EC-R

versenkt gebohrt,
mit Kleberillen
countersunk drilled,
fluted for glueing

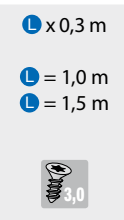
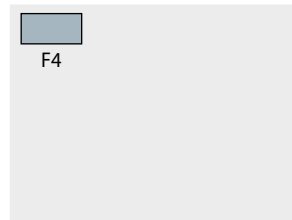
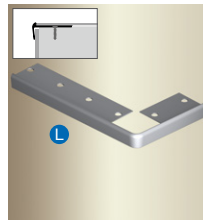
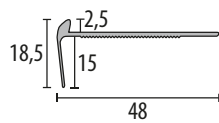

SBS	EC
•	•
•	•

859 EC-L

versenkt gebohrt,
mit Kleberillen
countersunk drilled,
fluted for glueing

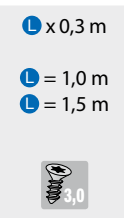
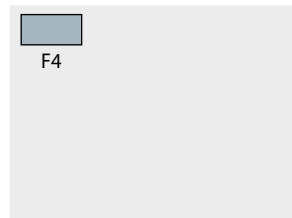
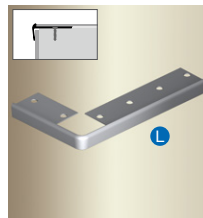
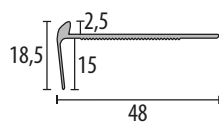

SBS	EC
•	•
•	•

860 EC

versenkt gebohrt,
mit Kleberillen
countersunk drilled,
fluted for glueing

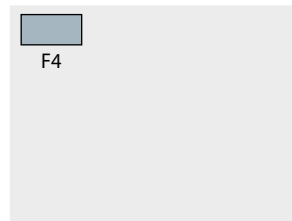
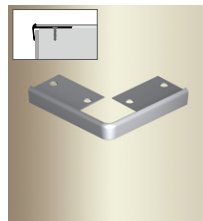
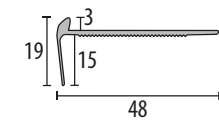

SBS	EC
•	•

860 EC-R

versenkt gebohrt,
mit Kleberillen
countersunk drilled,
fluted for glueing

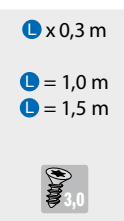
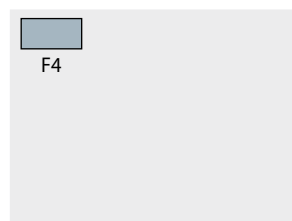
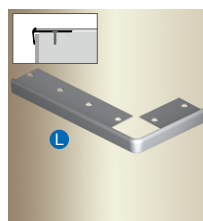
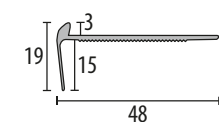

SBS	EC
•	•
•	•

860 EC-L

versenkt gebohrt,
mit Kleberillen
countersunk drilled,
fluted for glueing

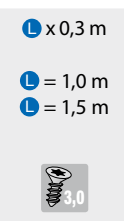
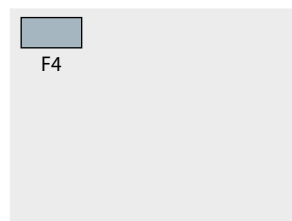
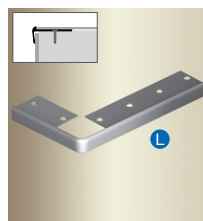
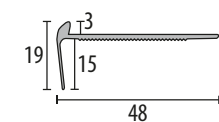

SBS	EC
•	•
•	•

Preise finden Sie ab Seite / Prices are indicated on page 192

- TK-Profile mit runden Ecken für LVT-, CV- oder PVC-Böden / Stair Nosings with Rounded Edges for LVT-, CV- or PVC-flooring

Artikel
article

Farbe
colour

Länge
length

Version
version

862 EC

versenkt gebohrt,
mit Kleberillen
countersunk drilled,
fluted for glueing

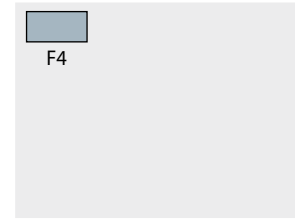
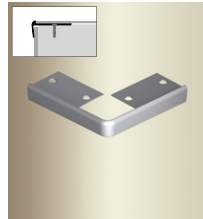
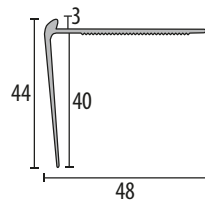

0,3 x 0,3 m	SBS	EC
	•	•

862 EC-R

versenkt gebohrt,
mit Kleberillen
countersunk drilled,
fluted for glueing

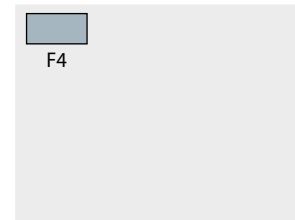
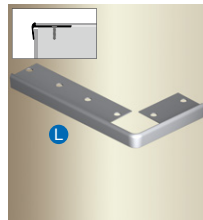
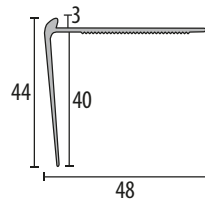

L x 0,3 m	SBS	EC
L = 1,0 m	•	•
L = 1,5 m	•	•

862 EC-L

versenkt gebohrt,
mit Kleberillen
countersunk drilled,
fluted for glueing

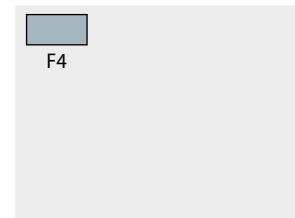
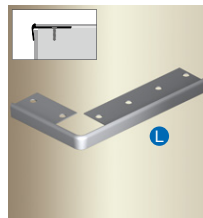
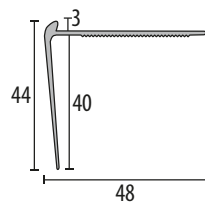

L x 0,3 m	SBS	EC
L = 1,0 m	•	•
L = 1,5 m	•	•

Preise finden Sie ab Seite / Prices are indicated on page 192



© Küberit®

S Sollbiegestelle
Predetermined Bending Point

L Länge
Length

Sonderlängen auf Anfrage!
Special lengths on request possible!

- TK-Profile mit runden Ecken für LVT-, CV- oder PVC-Böden / Stair Nosings with Rounded Edges for LVT-, CV- or PVC-flooring

Artikel
article

Farbe
colour

Länge
length

Version
version

870 EC/EV

doppelt versenkt
gebohrt, mit Kleberillen
double countersunk
drilled, fluted for glueing

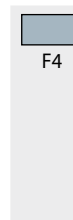
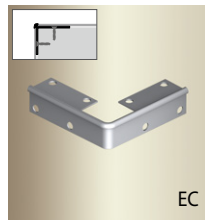
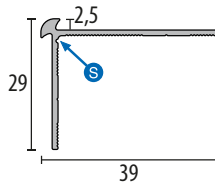

0,3 m x 0,3 m
x 0,2 m

SBS	EC	EV
•	•	•

870 EC-R/EV-R

doppelt versenkt
gebohrt, mit Kleberillen
double countersunk
drilled, fluted for glueing

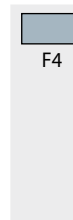
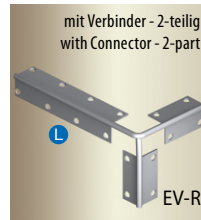
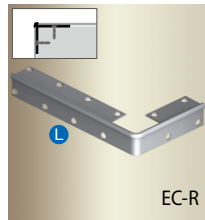
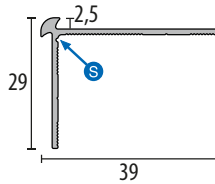

L x 0,3 x 0,2 m
L = 1,0 m
L = 1,5 m

SBS	EC	EV
•	•	•
•	•	•

870 EC-L/EV-L

doppelt versenkt
gebohrt, mit Kleberillen
double countersunk
drilled, fluted for glueing

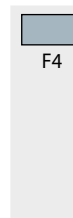
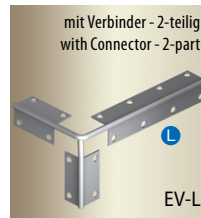
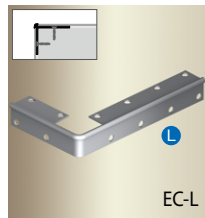
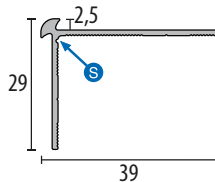

L x 0,3 x 0,2 m
L = 1,0 m
L = 1,5 m

SBS	EC	EV
•	•	•
•	•	•

871 EC/EV

doppelt versenkt
gebohrt, mit Kleberillen
double countersunk
drilled, fluted for glueing

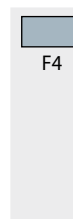
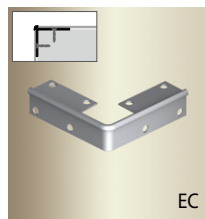
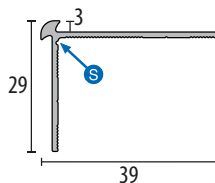

0,3 m x 0,3 m
x 0,2 m

SBS	EC	EV
•	•	•

871 EC-R/EV-R

doppelt versenkt
gebohrt, mit Kleberillen
double countersunk
drilled, fluted for glueing

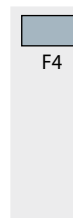
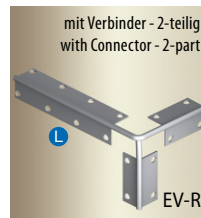
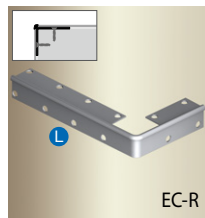
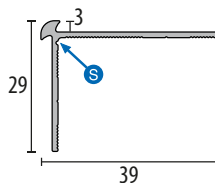

L x 0,3 x 0,2 m
L = 1,0 m
L = 1,5 m

SBS	EC	EV
•	•	•
•	•	•

871 EC-L/EV-L

doppelt versenkt
gebohrt, mit Kleberillen
double countersunk
drilled, fluted for glueing

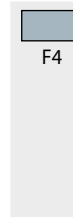
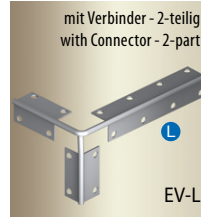
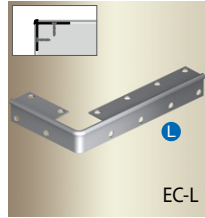
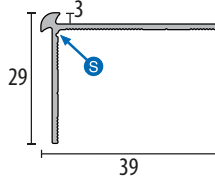

L x 0,3 x 0,2 m
L = 1,0 m
L = 1,5 m

SBS	EC	EV
•	•	•
•	•	•

Preise finden Sie ab Seite / Prices are indicated on page 192

S Sollbiegestelle
Predetermined Bending Point

L Länge
Length

Sonderlängen auf Anfrage!
Special lengths on request possible!

Treppenkantenprofile mit runden Eckelementen aus Aluminium für die sichere Treppenverlegung:

- zeitsparend, da keine aufwendigen Gehrungsschnitte auf der Baustelle notwendig sind
- offene Treppen können barfuß begangen werden
- zusätzlich ist bei den Profilen 870 und 871 ein Verbindungselement für die Setzstufe erhältlich
- optimal für Thermen, Saunalandschaften usw. geeignet

Ready-made aluminium corners with rounded edges for a safe stair nosing finish:

- time-saving, no laborious miter cuts required on site
- no sharp edges, open staircases can be safely used barefoot
- available with a separate connector for 870 and 871
- best for thermal baths, saunas or spas

■ TK-Profil mit runden Ecken für LVT-, CV- oder PVC-Böden / Stair Nosings with Rounded Edges for LVT-, CV- or PVC-flooring

Artikel
article

Farbe
colour

Länge
length

Version
version

845 EC

versenkt gebohrt,
mit Kleberillen
countersunk drilled,
fluted for glueing

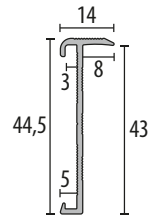

F4	0,3 x 0,3 m	SBS •	EC •
			

845 EC-R

versenkt gebohrt,
mit Kleberillen
countersunk drilled,
fluted for glueing

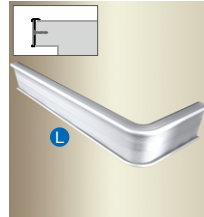
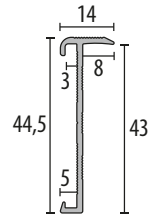

F4	L x 0,3 m L = 1,0 m	SBS •	EC •
			

845 EC-L

versenkt gebohrt,
mit Kleberillen
countersunk drilled,
fluted for glueing

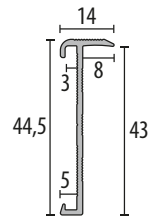

F4	L x 0,3 m L = 1,0 m	SBS •	EC •
			

846 EC

versenkt gebohrt,
mit Kleberillen
countersunk drilled,
fluted for glueing

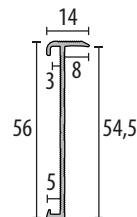

F4	0,3 x 0,3 m	SBS •	EC •
			

846 EC-R

versenkt gebohrt,
mit Kleberillen
countersunk drilled,
fluted for glueing

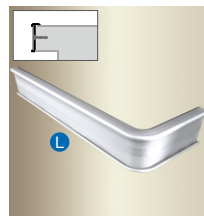
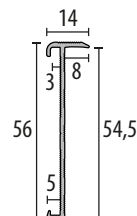

F4	L x 0,3 m L = 1,0 m	SBS •	EC •
			

846 EC-L

versenkt gebohrt,
mit Kleberillen
countersunk drilled,
fluted for glueing

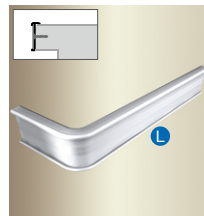
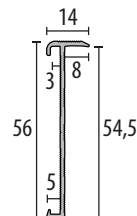

F4	L x 0,3 m L = 1,0 m	SBS •	EC •
			

Preise finden Sie ab Seite / Prices are indicated on page 192

L Länge
Length

■ Treppenkantenprofile für LED-Leuchten / Stair Nosings for LED lights

Artikel
article

Farbe
colour

Länge
length

Version
version

890

für LED-Leuchten,
versenkt gebohrt
for LED lights,
countersunk drilled

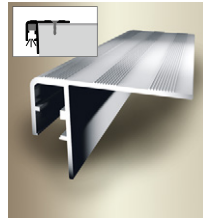
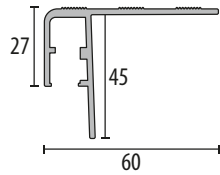

F2	F3	F4	F5
F6	F9		

3,0 m

3,5

für/for LED

SBS	V
•	•

891

für LED-Leuchten,
versenkt gebohrt
for LED lights,
countersunk drilled

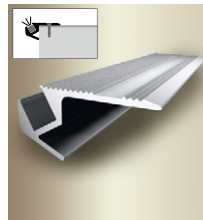
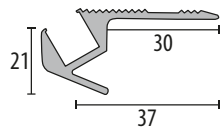

F2	F3	F4	F5
F6	F9		

2,5 m
5,0 m

3,0

für/for LED

SBS	V
•	•
•	•

Preise finden Sie ab Seite / Prices are indicated on page 193



890

© Klibert®

Zubehör / Accessories

899

LED-Leuchten, dimmbar
LED lights, dimmable

kaltweiß, trennbar alle 16,7 cm
cool white, separable each 16,7 cm

22 Watt / 24 Volt

10 m: eine 10 m Rolle inkl. 1,5 m Zuleitung
one 10 m roll incl. 1,5 m power cable

2,5 m + 1,0 m:

inkl. Set 895 V / incl. set 895 V

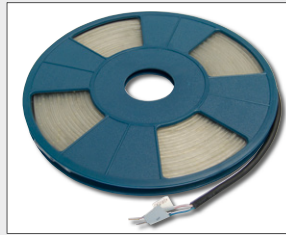

6 LED's pro Teilabschnitt,
360 LED's insgesamt,
pro Rolle 22 Watt
6 LEDs each section,
360 LEDs in total,
22 Watt per roll

Lichttemperatur / Light color temperature 6000-6800 Kelvin (IP68)

895 V

Verbindungsset,
für LED-Leuchten
connecting set,
for LED lights

Inhalt / Set
1 x 1,5 m Zuleitung
power cable

1 x Längsverbinder
lengthwise-connector

1 x Endkappe / end cap

3 x Schrumpfschlauch
heat shrinkable tubes



für / for 24 Watt

895 L

Längsverbinder und
Schrumpfschläuche
für LED-Leuchten
lengthwise-connector and
heat shrinkable tubes
for LED lights



Inhalt / Set

10 x Längsverbinder / 10 x lengthwise-connector
10 x Schrumpfschläuche / 10 x heat shrinkable tubes

894

Rohr
für LED-Leuchten
tube for LED lights

klar / transparent
rot / red
blau / blue
milchig / frosted

2 m

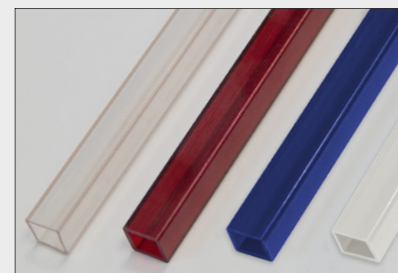

898

Diffuser,
für LED-Rohr
diffuser, for LED tube

weiß, für mattes Licht
white, for mat light

10 m Rolle / roll
2,5 m, 1,0 m

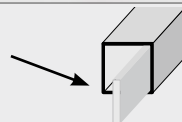
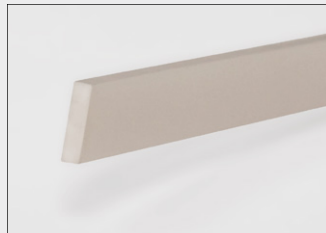

896

LED-Driver,
LED-driver,

für 5 m LED / for 5 m LED

1 x 24 Volt, 12 Watt

inkl. 2 m Zuleitung und Euroflachstecker
incl. 2 m power cable and euro connector plug



893

LED-Dimmer,
LED-dimmer

24V, max 240W, 10A



897

LED-Driver,
LED-driver,

für 25 m LED / for 25 m LED

1 x 24 Volt, 60 Watt

inkl. 2 m Zuleitung und Euroflachstecker
incl. 2 m power cable and euro connector plug



Preise finden Sie ab Seite / Prices are indicated on page 193



Treppenläuferstangen und Türstopper / Stairrods and Door Stoppers



Treppenläuferstangen, Heizrohrrosetten und Türstopper

Stairrods, Heating Pipe Collars and Door Stoppers



Best-Profile

- Treppenläuferstangen, Heizrohrrosetten und Türstopper
Stairrods, Heating Pipe Collars and Door Stoppers

Für die optimale und zugleich dekorative Verlegung von hochwertigen Teppichläufern auf Treppen bietet *Küberit* Messingtreppenstangen in allen gängigen Ausführungen. Und auch bei dem passenden Zubehör müssen Sie nicht auf die bewährte *Küberit*-Qualität verzichten. Ergänzt wird das Sortiment mit Türstoppern aus massivem Messing und Aluminium-Heizrohrrosetten.

With its range of stairrods *Küberit* provides your stairs with a perfect finish and a decorative design. The brass stairrods are available in the most popular designs. Matching accessories are also available in the well-known quality of *Küberit* products. Solid brass door stoppers and aluminium heating pipe collars complete the range of accessories.

Treppenläuferstangen, Heizrohrrosetten und Türstopper

Stairrods, Heating Pipe Collars and Door Stoppers

Artikel
article

Farbe
colour

Abmessungen
measurements

Länge
length

730
Treppenstangen mit
Eichelknöpfen, hohl
stairrods with
endstops, hollow



- F7 Messing poliert
brass polished
- F71 Messing glanz vernickelt
brass nickel-plated brilliant
- F72 Messing matt vernickelt
brass nickel-plated matt

70 cm
75 cm
80 cm
90 cm
100 cm

Ø 9 mm Ø 11 mm

Unterschiedliche
Längen und
Durchmesser bei
den Farben – siehe
S. 193!
Different lengths
and diameters
for the colours - see
page 193!

731
Winkelöse,
seitlich offen
stairrod clip,
laterally open



- F7 Messing poliert
brass polished
- F71 Messing glanz vernickelt
brass nickel-plated brilliant
- F72 Messing matt vernickelt
brass nickel-plated matt
- F73 Messing brüniert
brass gunmetal finish
- F74 Messing schwarz
brass black

1 Paar für / 1 pair for Ø 9 mm
1 Paar für / 1 pair for Ø 11 mm
1 Paar für / 1 pair for Ø 13 mm

1 Paar = 2 Stück / 1 pair = 2 pieces

732
Ringöse,
mit Madenschraube
und eingeklebter
Stockschraube
stairrod eye,
with grub screws
and glued stair bolt



- F7 Messing poliert
brass polished
- F71 Messing glanz vernickelt
brass nickel-plated brilliant
- F72 Messing matt vernickelt
brass nickel-plated matt
- F73 Messing brüniert
brass gunmetal finish
- F74 Messing schwarz
brass black

1 Paar für / 1 pair for Ø 9 mm
1 Paar für / 1 pair for Ø 11 mm
1 Paar für / 1 pair for Ø 13 mm

1 Paar = 2 Stück / 1 pair = 2 pieces

733
Treppenstangen
mit Eichelknöpfen,
mit Stahlkern
stairrods
with endstops,
with steel core







- F7 Messing poliert
brass polished
- F71 Messing glanz vernickelt
brass nickel-plated brilliant
- F72 Messing matt vernickelt
brass nickel-plated matt
- F73 Messing brüniert
brass gunmetal finish
- F74 Messing schwarz
brass black

60 cm
65 cm
70 cm
75 cm
80 cm
90 cm
100 cm
105 cm
110 cm

Ø 9 mm Ø 11 mm Ø 13 mm

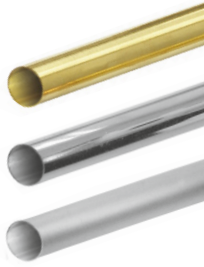
Unterschiedliche
Längen und
Durchmesser bei
den Farben – siehe
S. 193!
Different lengths
and diameters
for the colours - see
page 193!

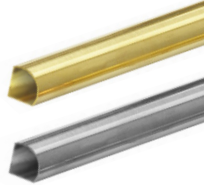
Preise finden Sie ab Seite / Prices are indicated on page 193

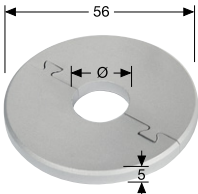
Artikel article	Farbe colour	Abmessungen measurements	Länge length	
734 Treppenstangen ohne Eichelknöpfe, hohl stairrods without endstops, hollow		F7 Messing poliert brass polished	500 cm 250 cm	
	F71 Messing glanz vernickelt brass nickel-plated brilliant	Ø 9 mm Ø 11 mm Unterschiedliche Längen und Durchmesser bei den Farben – siehe S. 194! Different lengths and diameters for the colours - see page 194!		
	F72 Messing matt vernickelt brass nickel-plated matt			
735 Eichelknöpfe endstops			F7 Messing poliert brass polished	für / for Ø 9 mm für / for Ø 11 mm
F71 Messing glanz vernickelt brass nickel-plated brilliant	736 Dreikant Treppenstangen, hohl triangular stairrods, hollow		F72 Messing matt vernickelt brass nickel-plated matt	16 x 16 mm 250 cm 500 cm
F7 Messing poliert brass polished	737 Dreikant Winkelöse, seitlich geschlossen triangular stairrod clips, laterally closed		F71 Messing glanz vernickelt brass nickel-plated brilliant	16 x 16 mm 250 cm
F71 Messing glanz vernickelt brass nickel-plated brilliant Silber-Optik / silver optic	738 Türstopper aus Messing, massiv door stopper made of brass, solid		F72 Messing matt vernickelt brass nickel-plated matt Edelstahl-Optik / stainless steel optic	1 Paar (2 Stück) 1 pair (2 piece)
F72 Messing matt vernickelt brass nickel-plated matt Edelstahl-Optik / stainless steel optic	739 Aluminium-Heizrohrrosette aluminium heating pipe collar		F2G eloxiert edelstahloptik fein geschliffen anodized stainless steel optic matt brushed	mit Spreitzdübel und Stockschraube mit Dübel with expansion anchor and hangerbolt with anchor
F4 eloxiert silber anodized silver	F2G eloxiert edelstahloptik fein geschliffen anodized stainless steel optic matt brushed	Ø 15 mm Ø 18 mm	Ø 31 mm	

Preise finden Sie ab Seite / Prices are indicated on page 194



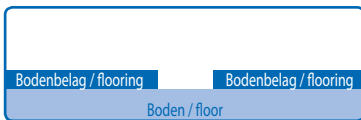

Einfach biegbare EB-, Doppel-K-, Dehnfugen- und Bewegungsfugenprofile

Easy Bendable Profiles, Perforated edge trims,
Expansion Joint Profiles and Movement Profiles



Best-Profile

- Einfach biegbare EB-, Doppel-K-, Dehnfugen- und Bewegungsfugenprofile
Easy Bendable Profiles, Perforated edge trims, Expansion Joint Profiles and Movement Profiles

Mit den *Küberit* **EB-Profilen** (Einfach Biegbare Profile) erhalten Sie eine saubere Trennung unterschiedlicher Bodenbeläge. Das Sortiment beinhaltet biegbare Profile, Profile für die gerade Verlegung und Dehnfugen- und Bewegungsfugenprofile. Die offen gestanzten **EB-Profile** und die T-Profile können von Hand oder mit der hochwertigen *Küberit*-**Biegemaschine** gebogen werden.

With *Küberit* **EB-Profiles** (Easy Bendable Profiles) you achieve decorative transitions between two floor coverings. The production range includes bendable profiles, profiles with perforated base and expansion joint and movement profiles. The pre-punched **EB-Profiles** and the T-profiles can be bent by hand or by using the high-grade *Küberit* **bending machine**.



■ Einfach biegbare Profile / Easy Bendable Profiles (=Version **EB**)

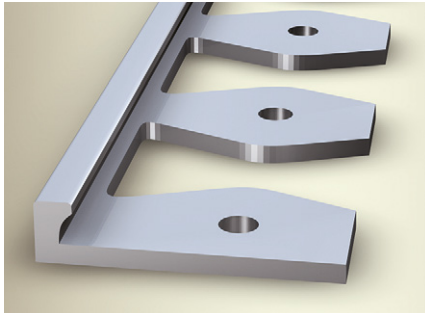

Die einfach biegbaren Profile können vor Ort von Hand oder mit unserer Biegemaschine gebogen werden.

- für alle Radien und Bögen
- perfekter Abschluss
- saubere Trennung von unterschiedlichen Bodenbelägen
- Befestigung durch Kleben, Nageln oder Schrauben
- lieferbar in Aluminium und Messing

Our Easy Bendable Profiles can be bent on-site by hand or by using our bending-machine

- for all diameters and curves
- perfect edges
- accurate separation of different floor coverings
- installation with adhesive, nails or screws
- available in aluminium and brass

■ Doppel-K Profile / Perforated edge trims (=Version **G**) ungestanzt / unpunched (=Version **U**)

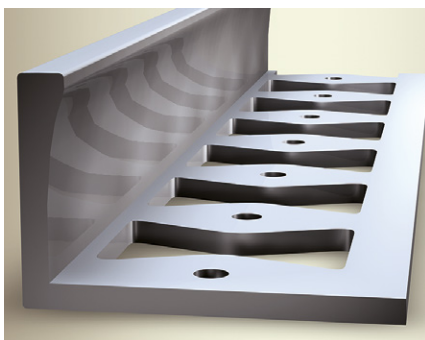

Ermöglichen exakte und gerade Abschlüsse vor anderen Bodenbelägen und anderen Erhöhungen:

- oder bei höheren, angrenzenden Schwellen, Kacheln, Fliesen, Terrassentüren und -fenstern
- schützen den Bodenbelag mit der geschlossenen Stanzung vor mechanischen Belastungen
- das Doppel-K-Lochbild ermöglicht auch eine Befestigung im Kleberbett
- können auch mit den einfach biegbaren Profilen kombiniert werden
- alle Profile auch ungestanzt lieferbar

For accurate transitions between different floor coverings, or other raisings:

- or higher adjacent sills, tiles, terrace doors and windows
- the profiles protect the flooring edges from mechanical charges
- the profiles with the perforated base can also be secured with the adhesive of the flooring
- easy to combine with the easily bendable perforated profiles
- all profiles can be supplied unpunched

■ Dehnfugenprofile / Expansion Joint Profiles (=Version **S**) und Bewegungsfugenprofile / Movement Profiles

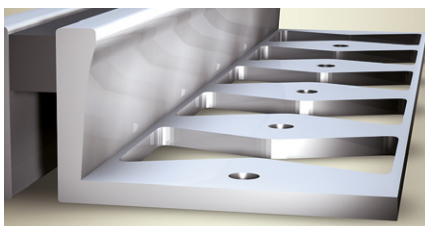

S10 grau S20 schwarz S30 beige S40 braun
S10 grey S20 black S30 beige S40 brown

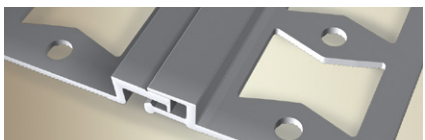

Dehnfugenprofile

- ermöglichen eine optimale Überbrückung von Estrich-Dehnfugen
- können bei einer starken mechanischen Belastung von keramischen Fliesenbelägen eingesetzt werden
- reduzieren die Übertragung von Trittschall
- EB-Version **S** mit reißfester Silikonfuge
- auf Anfrage ist die Silikonfuge auch in weiteren Farben erhältlich
- auch als zweiteiliges Bewegungsfugenprofil erhältlich (siehe Seite 76)

Expansion joint profiles

- are an ideal bridging of expansion joints in the sub floor
- the profiles with the perforated base can also be secured with the adhesive of the flooring
- improves sound insulation
- EB-Version **S** with resistant silicone joint
- on request, the silicone joint is also available in other colours
- also available as two-part Expansion Joint Profiles (see page 76)

■ Biegbare Einfass- und Abschlussprofile / Bendable Trims and Border Profiles (=Version **EB**)

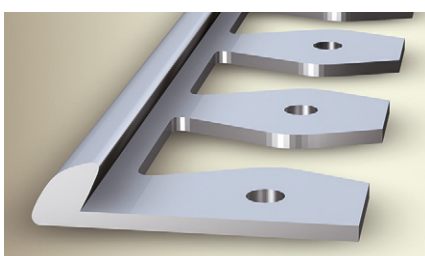

Biegbare Einfass- und Abschlussprofile von Küberit

Mit den offen gestanzten Profilen aus dem Sortiment *Küberit-Best* sind saubere, gebogene Abschlüsse vor anderen Bodenbelägen oder höheren, angrenzenden Schwellen und Übergängen zwischen verschiedenen Bodenbelägen möglich.

Küberit's pre-bendable edge trims

Open punched profiles, which are part of the *Küberit-Best* assortment, achieves decorative transitions between two floor coverings. They are suitable for floors bordering higher adjacent sills and allow an accurate separation of different floor coverings.

EB-Profile, Doppel-K Profile und Dehnfugenprofile / EB-Profiles, Perforated edge trims and Expansion Joint Profiles

Artikel
article

Farbe
colour

Länge
length

Version
version

299

EB = \varnothing min 40 cm

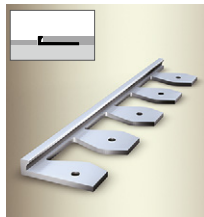
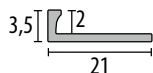

				2,5 m	SBS •	EB •	G •	U •
F15	F16						G •	U •

300

EB = \varnothing min 40 cm

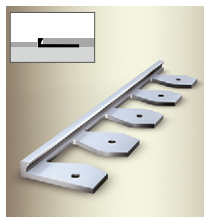
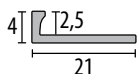

				2,5 m	SBS •	EB •	G •	U •

300 S

mit reißfester Silikonfuge in grau
with a grey flexible silicone joint

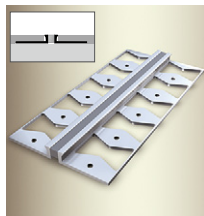
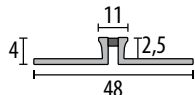

				2,5 m	SBS •	S •		

301

EB = \varnothing min 40 cm

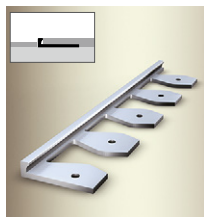
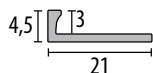

				2,5 m 3,0 m	SBS •	EB •	G •	U •
								* nur/only F0, F2, F4 ** nicht/not in U *** nur/only in G

301 S

mit reißfester Silikonfuge in grau,
schwarz, beige oder braun
with a grey, black, beige or
brown flexible silicone joint

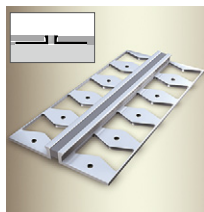
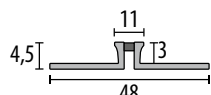

				2,5 m 3,0 m	SBS •	S •		
								* nur/only F4

302

EB = \varnothing min 40 cm

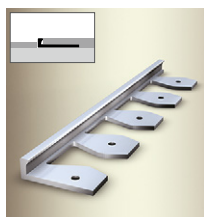
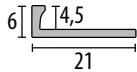

				2,5 m 3,0 m	SBS •	EB •	G •	U •
								* nur/only F0, F2, F4 ** nicht/not in U *** nur/only in G

302 S

mit reißfester Silikonfuge in grau,
schwarz, beige oder braun
with a grey, black, beige or
brown flexible silicone joint

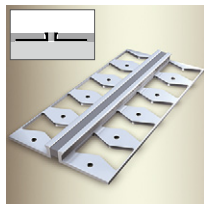
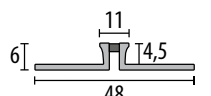

				2,5 m 3,0 m	SBS •	S •		
								* nur/only F4

Preise finden Sie ab Seite / Prices are indicated on page 194



Einfach biegbare EB-, Doppel-K-, Dehnfugen- und Bewegungsfugenprofile

Easy Bendable Profiles, Perforated edge trims, Expansion Joint Profiles and Movement Profiles

EB-Profile, Doppel-K Profile und Dehnfugenprofile / EB-Profiles, Perforated edge trims and Expansion Joint Profiles

Artikel
article

Farbe
colour

Länge
length

Version
version

307

EB = \varnothing min 40 cm

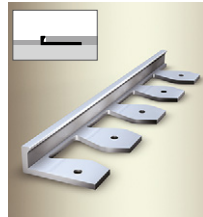
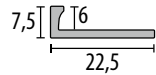

F0	F2	F3	F4
F5	F6	F9	
F7**	F8***		

2,5 m	SBS	EB	G	U
3,0 m	•	•	•	•
			•*	

* nur/only F0, F2, F4
** nicht/not in U
*** nur/only in G

307 S

mit reißfester Silikonfuge in grau,
schwarz, beige oder braun
with a grey, black, beige or
brown flexible silicone joint

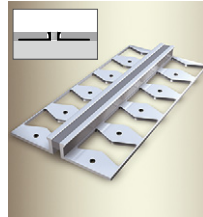
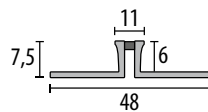

F4	F8	F6	F9
S10	S10	S40	S30
S20	S20		

2,5 m	SBS	S		
3,0 m	•	•		
	•	•*		

* nur/only F4

303

EB = \varnothing min 40 cm

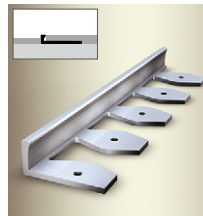
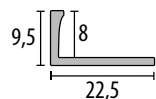

F0	F2	F3	F4
F5**	F6**	F9**	
F7**	F8***		

2,5 m	SBS	EB	G	U
3,0 m	•	•	•	•
			•*	



* nur/only F0, F2, F4
** nicht/not in U
*** nur/only in G

Preise finden Sie ab Seite / Prices are indicated on page 195

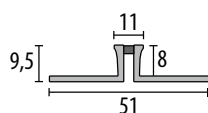
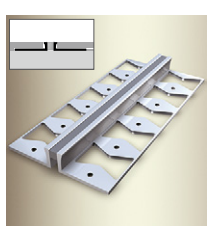
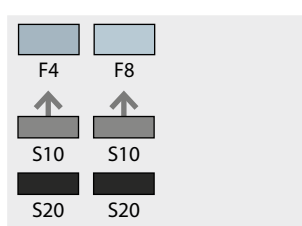
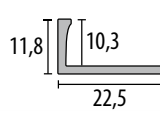
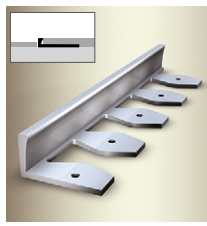
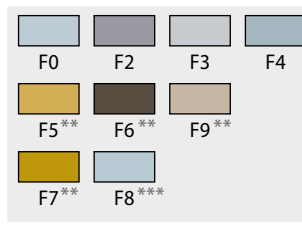
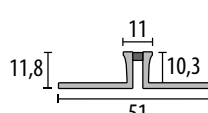
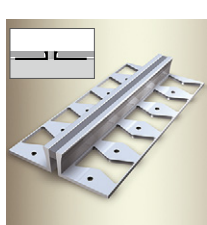

301 S

EB-Profile, Doppel-K Profile und Dehnfugenprofile / EB-Profiles, Perforated edge trims and Expansion Joint Profiles

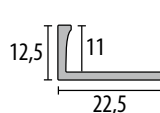
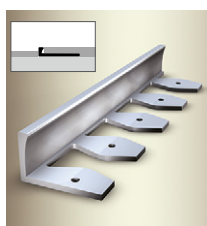
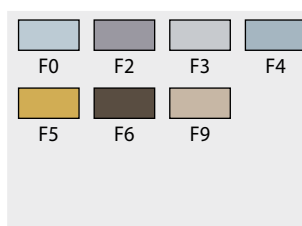
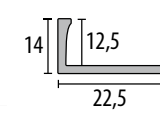
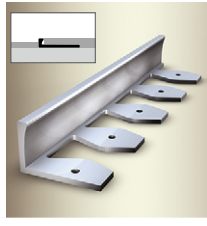
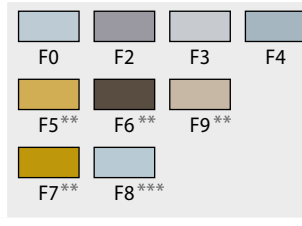
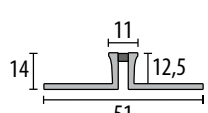
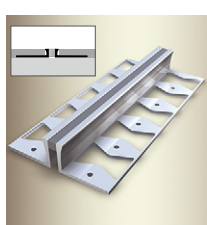
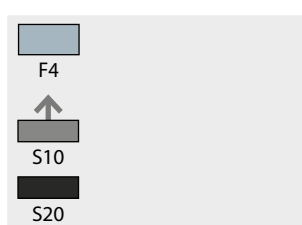
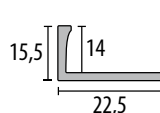
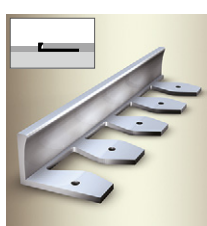
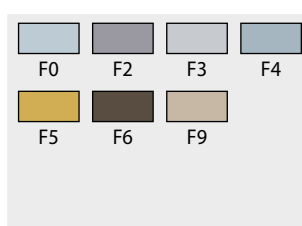
Artikel article	Farbe colour	Länge length	Version version								
303 S mit reißfester Silikonfuge in grau oder schwarz with a grey or black flexible silicone joint	 		2,5 m <table border="1"> <tr> <td>SBS</td> <td>S</td> <td></td> <td></td> </tr> <tr> <td>•</td> <td>•</td> <td></td> <td></td> </tr> </table>	SBS	S			•	•		
SBS	S										
•	•										
304 EB = Ø min 40 cm	 		2,5 m <table border="1"> <tr> <td>SBS</td> <td>EB</td> <td>G</td> <td>U</td> </tr> <tr> <td>•</td> <td>•</td> <td>•</td> <td>•</td> </tr> </table> <p>** nicht/not in U *** nur/only in G</p>	SBS	EB	G	U	•	•	•	•
SBS	EB	G	U								
•	•	•	•								
304 S mit reißfester Silikonfuge in grau oder schwarz with a grey or black flexible silicone joint	 		2,5 m <table border="1"> <tr> <td>SBS</td> <td>S</td> <td></td> <td></td> </tr> <tr> <td>•</td> <td>•</td> <td></td> <td></td> </tr> </table>	SBS	S			•	•		
SBS	S										
•	•										
308 EB = Ø min 40 cm	 		2,5 m <table border="1"> <tr> <td>SBS</td> <td>EB</td> <td>G</td> <td>U</td> </tr> <tr> <td>•</td> <td>•*</td> <td>•</td> <td>•**</td> </tr> </table> <p>* nicht/not in F3 ** nicht/not in F5, F6 & F7</p>	SBS	EB	G	U	•	•*	•	•**
SBS	EB	G	U								
•	•*	•	•**								
305 EB = Ø min 40 cm	 		2,5 m <table border="1"> <tr> <td>SBS</td> <td>EB</td> <td>G</td> <td>U</td> </tr> <tr> <td>•</td> <td>•*</td> <td>•</td> <td>•</td> </tr> </table> <p>* nicht/not in F3 ** nicht/not in U *** nur/only in G</p>	SBS	EB	G	U	•	•*	•	•
SBS	EB	G	U								
•	•*	•	•								
305 S mit reißfester Silikonfuge in grau oder schwarz with a grey or black flexible silicone joint	 		2,5 m <table border="1"> <tr> <td>SBS</td> <td>EB</td> <td>G</td> <td>U</td> </tr> <tr> <td>•</td> <td>•</td> <td>•</td> <td>•</td> </tr> </table>	SBS	EB	G	U	•	•	•	•
SBS	EB	G	U								
•	•	•	•								
311 EB = Ø min 40 cm	 		2,5 m <table border="1"> <tr> <td>SBS</td> <td>EB</td> <td>G</td> <td>U</td> </tr> <tr> <td>•</td> <td>•</td> <td>•</td> <td>•*</td> </tr> </table> <p>* nicht/not in F5, F6 & F9</p>	SBS	EB	G	U	•	•	•	•*
SBS	EB	G	U								
•	•	•	•*								

Preise finden Sie ab Seite / Prices are indicated on page 195

Einfach biegbare EB-, Doppel-K-, Dehnfugen- und Bewegungsfugenprofile

Easy Bendable Profiles, Perforated edge trims, Expansion Joint Profiles and Movement Profiles

EB-Profil, Doppel-K Profil und Dehnfugenprofile / EB-Profiles, Perforated edge trims and Expansion Joint Profiles

Artikel article		Farbe colour	Länge length	Version version																
306 EB = \varnothing min 40 cm			2,5 m	SBS • EB • G • U •																
		<table border="1"> <tr> <td>F0</td> <td>F2</td> <td>F3</td> <td>F4</td> </tr> <tr> <td>F5**</td> <td>F6**</td> <td>F9**</td> <td></td> </tr> <tr> <td>F7**</td> <td>F8***</td> <td></td> <td></td> </tr> </table>	F0	F2	F3	F4	F5**	F6**	F9**		F7**	F8***				** nicht/not in U *** nur/only in G				
F0	F2	F3	F4																	
F5**	F6**	F9**																		
F7**	F8***																			
306 S mit reißfester Silikonfuge in grau oder schwarz with a grey or black flexible silicone joint			2,5 m	SBS • EB • G • U •																
		<table border="1"> <tr> <td>F4</td> <td></td> <td></td> <td></td> </tr> <tr> <td>↑</td> <td></td> <td></td> <td></td> </tr> <tr> <td>S10</td> <td></td> <td></td> <td></td> </tr> <tr> <td>S20</td> <td></td> <td></td> <td></td> </tr> </table>	F4				↑				S10				S20					
F4																				
↑																				
S10																				
S20																				
312 EB = \varnothing min 45 cm			2,5 m	SBS • EB • G • U •*																
		<table border="1"> <tr> <td>F0</td> <td>F2</td> <td>F3</td> <td>F4</td> </tr> <tr> <td>F5</td> <td>F6</td> <td>F9</td> <td></td> </tr> </table>	F0	F2	F3	F4	F5	F6	F9			* nicht/not in F5, F6 & F9								
F0	F2	F3	F4																	
F5	F6	F9																		
313 EB = \varnothing min 45 cm			2,5 m	SBS • EB •* G • U •**																
		<table border="1"> <tr> <td>F0</td> <td>F2</td> <td>F3</td> <td>F4</td> </tr> <tr> <td>F5</td> <td>F6</td> <td>F9</td> <td></td> </tr> </table>	F0	F2	F3	F4	F5	F6	F9			* nicht/not in F3 ** nicht/not in F5, F6 & F9								
F0	F2	F3	F4																	
F5	F6	F9																		
309 EB = \varnothing min 45 cm			2,5 m	SBS • EB •* G • U •																
		<table border="1"> <tr> <td>F0</td> <td>F2</td> <td>F3</td> <td>F4</td> </tr> <tr> <td>F5**</td> <td>F6**</td> <td>F9**</td> <td></td> </tr> <tr> <td>F7**</td> <td>F8***</td> <td></td> <td></td> </tr> </table>	F0	F2	F3	F4	F5**	F6**	F9**		F7**	F8***				* nicht/not in F3 ** nicht/not in U *** nur/only in G				
F0	F2	F3	F4																	
F5**	F6**	F9**																		
F7**	F8***																			
338 G geschlossen gestanz closed punched			2,5 m	SBS • G •																
		<table border="1"> <tr> <td>F0</td> <td>F2</td> <td>F3</td> <td>F4</td> </tr> <tr> <td>F5</td> <td>F6</td> <td>F9</td> <td></td> </tr> </table>	F0	F2	F3	F4	F5	F6	F9											
F0	F2	F3	F4																	
F5	F6	F9																		
335 G geschlossen gestanz closed punched			2,5 m	SBS • G •																
		<table border="1"> <tr> <td>F0</td> <td>F2</td> <td>F3</td> <td>F4</td> </tr> <tr> <td>F5</td> <td>F6</td> <td>F9</td> <td></td> </tr> </table>	F0	F2	F3	F4	F5	F6	F9											
F0	F2	F3	F4																	
F5	F6	F9																		

Preise finden Sie ab Seite / Prices are indicated on page 196

■ Doppel-K Profile und Rampenprofil / Perforated edge trims and Ramp Profile

Artikel
article

Farbe
colour

Länge
length

Version
version

336 G

geschlossen gestanzt
closed punched

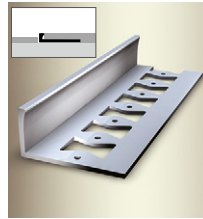
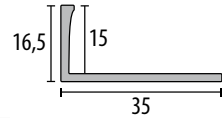

				2,5 m	SBS •	G •

Preise finden Sie ab Seite / Prices are indicated on page 197

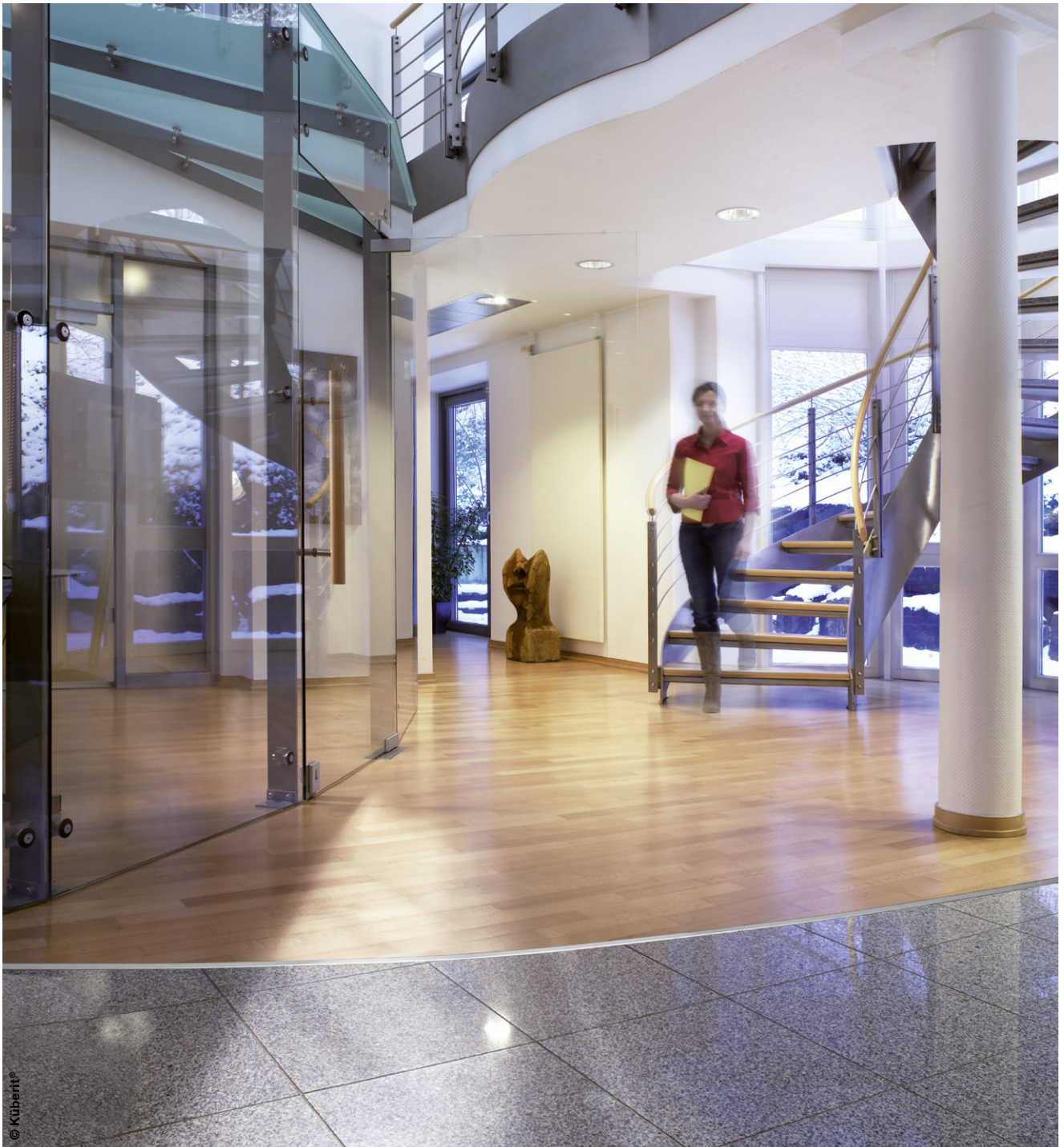

© Küberit®

■ Bewegungsfugenprofile / Expansion Joint Profiles (Motion-Star)

Artikel
article

Farbe
colour

Länge
length

Version
version

316
versenkt gebohrt
oder selbstklebend
countersunk drilled
or self-adhesive

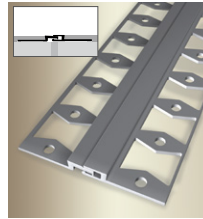
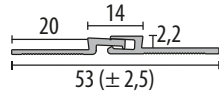

F2	F4								
				2,7 m	SBS •	V •			SK •

317
versenkt gebohrt,
geschlossen gestanzt
oder selbstklebend
countersunk drilled,
closed punched or
self-adhesive

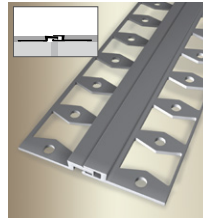
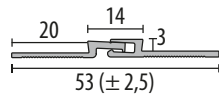

F2	F4	F6	F9						
				2,7 m	SBS •	V •	G •		SK •*

* nur/only F2 & F4

318
geschlossen gestanzt
oder selbstklebend
closed punched or
self-adhesive

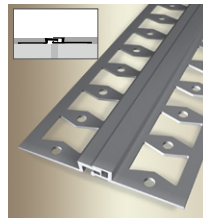
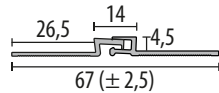

F2	F4	F6	F9						
				2,7 m	SBS •		G •		SK •*

* nur/only F2 & F4

319 G
geschlossen gestanzt
closed punched

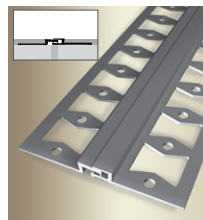
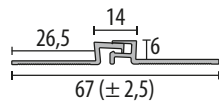

F2	F4	F6	F9						
				2,7 m	SBS •		G •		

323 G
geschlossen gestanzt
closed punched

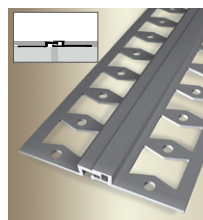
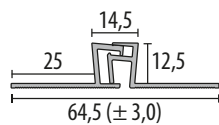

F2	F4								
				2,7 m	SBS •		G •		

324 G
geschlossen gestanzt
closed punched

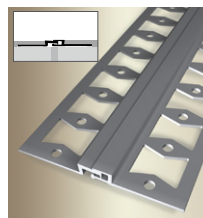
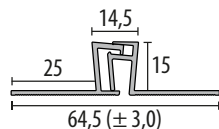

F2	F4								
				2,7 m	SBS •		G •		

Preise finden Sie ab Seite / Prices are indicated on page 197

■ Bewegungsfugenprofile / Expansion Joint Profiles



■ Biegbare Einfass- und Abschlussprofile / Easily Bendable Border Profiles

Artikel
article

Farbe
colour

Länge
length

Version
version

356 EB

EB = \varnothing min 40 cm

EB = \varnothing min 80 cm

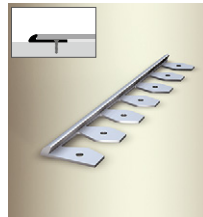
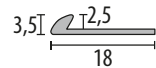

F4	2,5 m	SBS •	EB •
----	-------	----------	---------

357 EB

EB = \varnothing min 40 cm

EB = \varnothing min 80 cm

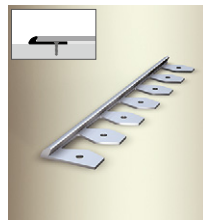
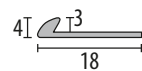

F4	2,5 m	SBS •	EB •
----	-------	----------	---------

359 EB

EB = \varnothing min 40 cm

EB = \varnothing min 80 cm

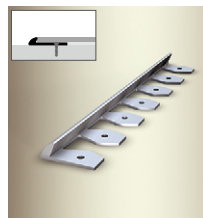
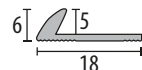

F4	2,5 m	SBS •	EB •
----	-------	----------	---------

361/3 EB

EB = \varnothing min 80 cm

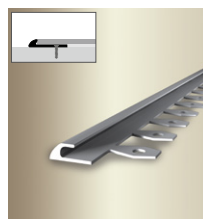
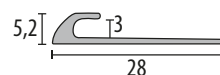

F4	2,5 m	SBS •	EB •
----	-------	----------	---------

Preise finden Sie ab Seite / Prices are indicated on page **197**

■ Biegbare Einfass- und Abschlussprofile / Easily Bendable Border Profiles

Artikel
article

Farbe
colour

Länge
length

Version
version

371 EB

EB = Ø min 250 cm

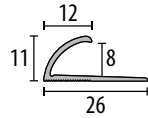

F4	2,7 m	SBS •	EB •
----	-------	----------	---------

363 EB

EB = Ø min 40 cm

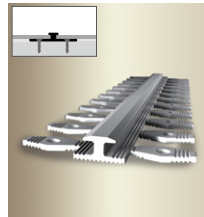
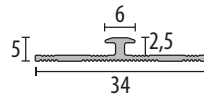

F4	2,7 m	SBS •	EB •
----	-------	----------	---------

365 EB

EB = Ø min 40 cm

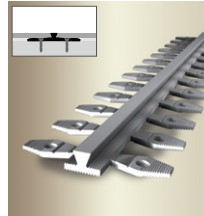
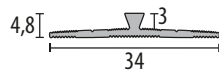

F4	3,0 m	SBS •	EB •
----	-------	----------	---------

366 EB

EB = Ø min 40 cm

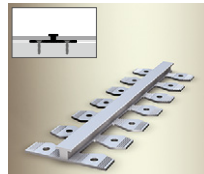
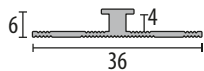

F4	2,7 m	SBS •	EB •
----	-------	----------	---------

368 EB

EB = Ø min 80 cm

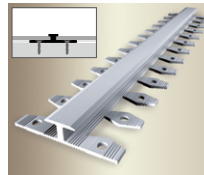
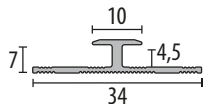

F4	2,7 m	SBS •	EB •
----	-------	----------	---------

345 EB

EB = Ø min 100 cm

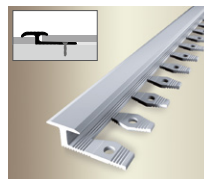
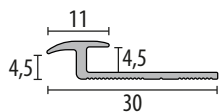

F4	3,0 m	SBS •	EB •
----	-------	----------	---------

297 EB

EB = Ø min 100 cm

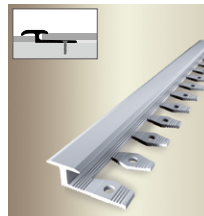
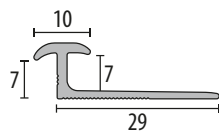

F4	2,7 m	SBS •	EB •
----	-------	----------	---------

801 EB

EB = Ø min 40 cm

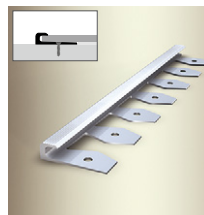
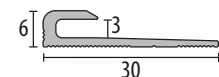

F4	2,5 m	SBS •	EB •
----	-------	----------	---------

Preise finden Sie ab Seite / Prices are indicated on page 197

■ Biegbare Einfass- und Abschlussprofile / Easily Bendable Border Profiles

Artikel
article

Farbe
colour

Länge
length

Version
version

802 EB

EB = \varnothing min 40 cm

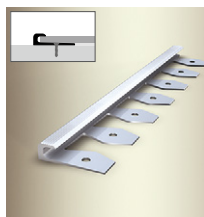
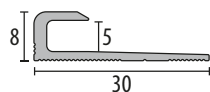

F4	2,5 m	SBS •	EB •
----	-------	----------	---------

803 EB

EB = \varnothing min 40 cm

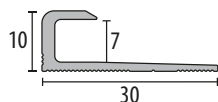

F4	2,5 m	SBS •	EB •
----	-------	----------	---------

804 EB

EB = \varnothing min 40 cm

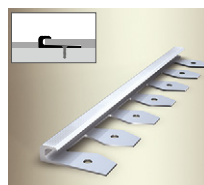
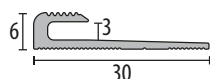

F4	2,5 m	SBS •	EB •
----	-------	----------	---------

806 EB

EB = \varnothing min 40 cm

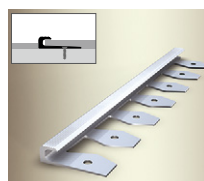
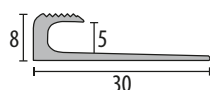

F4	2,5 m	SBS •	EB •
----	-------	----------	---------

805 EB

EB = \varnothing min 40 cm

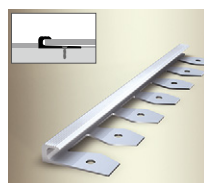
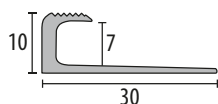

F4	2,5 m	SBS •	EB •
----	-------	----------	---------

210 EB

EB = \varnothing min 300 cm

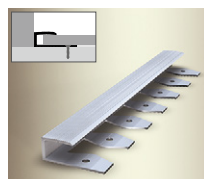
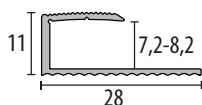

F4	2,7 m	SBS •	EB •
----	-------	----------	---------

212 EB

EB = \varnothing min 300 cm

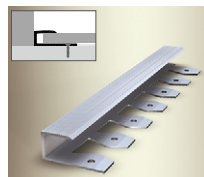
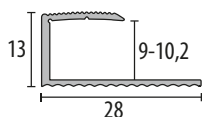

F4	2,7 m	SBS •	EB •
----	-------	----------	---------

213 EB

EB = \varnothing min 300 cm

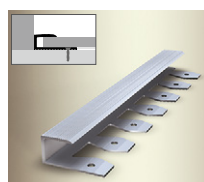
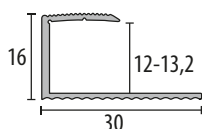

F4	2,7 m	SBS •	EB •
----	-------	----------	---------

Preise finden Sie ab Seite / Prices are indicated on page 197

■ Biegbare Treppenkantenprofile / Bendable Stair Nosings

Artikel
article

Farbe
colour

Länge
length

Version
version

809 EB

EB = \varnothing min 300 cm

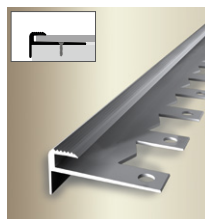
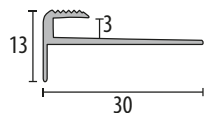

		5,0 m 2,5 m	SBS •	EB •
F2	F4			

807 EB

EB = \varnothing min 150 cm

EB = \varnothing min 300 cm

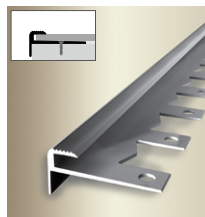
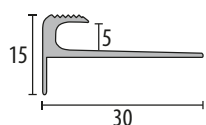

		5,0 m 2,5 m	SBS •	EB •
F2	F4			

808 EB

EB = \varnothing min 150 cm

EB = \varnothing min 250 cm

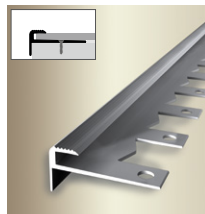
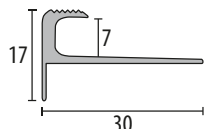

		5,0 m 2,5 m	SBS •	EB •
F2	F4			

810 EB

EB = \varnothing min 200 cm

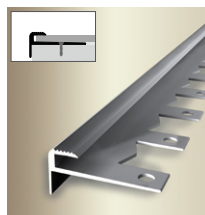
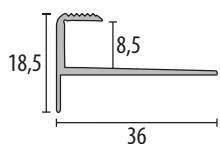

		5,0 m 2,5 m	SBS •	EB •
F2	F4			

811 EB

EB = \varnothing min 200 cm

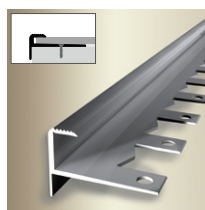
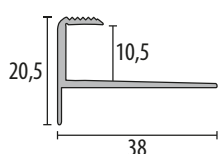

		5,0 m 2,5 m	SBS •	EB •
F2	F4			

812 EB

EB = \varnothing min 150 cm

EB = \varnothing min 200 cm

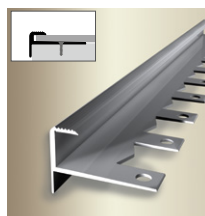
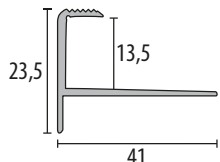

		5,0 m 2,5 m	SBS •	EB •
F2	F4			

813 EB

EB = \varnothing min 150 cm

EB = \varnothing min 200 cm

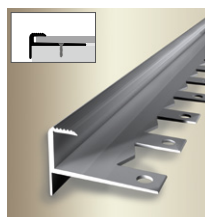
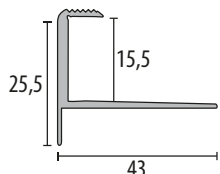

		5,0 m 2,5 m	SBS •	EB •
F2	F4			

Preise finden Sie ab Seite / Prices are indicated on page 197

■ Biegbare Treppenkantenprofile / Bendable Stair Nosings

Artikel
article

Farbe
colour

Länge
length

Version
version

852 EB

EB = \varnothing min 500 cm

EB = \varnothing min 300 cm

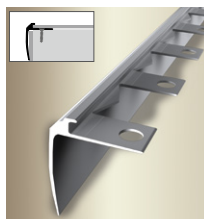
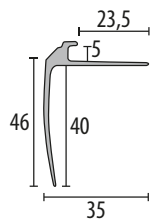

F2	F4	5,0 m	SBS	EB
		2,5 m	•	•
			•	•

859 EB

EB = \varnothing min 80 cm

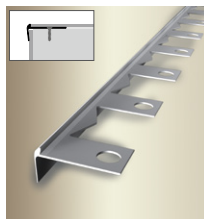
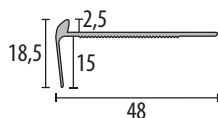

F2	F4	5,0 m	SBS	EB
		2,5 m	•	•
			•	•

860 EB

EB = \varnothing min 80 cm

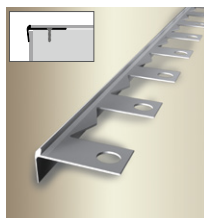
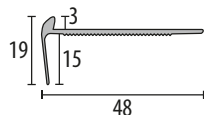

F2	F4	F7	5,0 m	SBS	EB
			2,5 m	•	•
				•	•

861 EB

EB = \varnothing min 80 cm

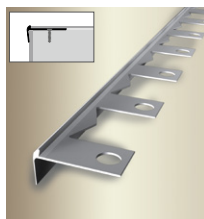
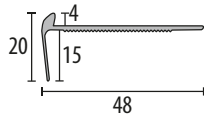

F2	F4	5,0 m	SBS	EB
		2,5 m	•	•
			•	•

863 EB

EB = \varnothing min 80 cm

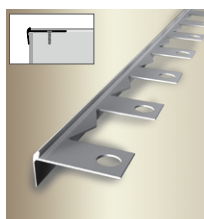
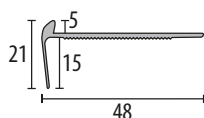

F2	F4	5,0 m	SBS	EB
		2,5 m	•	•
			•	•

864 EB

EB = \varnothing min 80 cm

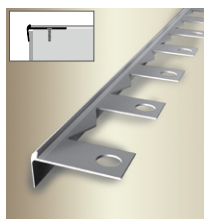
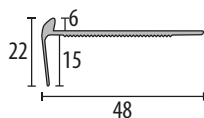

F2	F4	5,0 m	SBS	EB
		2,5 m	•	•
			•	•

862 EB

EB = \varnothing min 80 cm

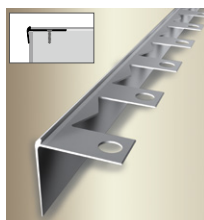
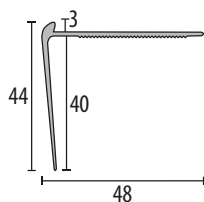

F2	F4	5,0 m	SBS	EB
		2,5 m	•	•
			•	•

Preise finden Sie ab Seite / Prices are indicated on page **197**

■ Biegbare Treppenkantenprofile / Bendable Stair Nosings

Artikel
article

Farbe
colour

Länge
length

Version
version

870 EB

EB = \varnothing min 80 cm

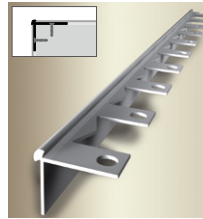
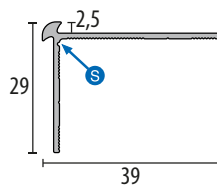

		5,0 m 2,5 m	SBS	EB
F2	F4		•	•

871 EB

EB = \varnothing min 80 cm

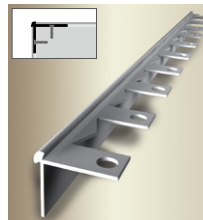
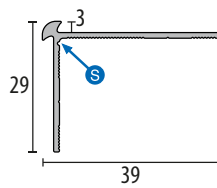

		5,0 m 2,5 m	SBS	EB
F2	F4		•	•

872 EB

EB = \varnothing min 80 cm

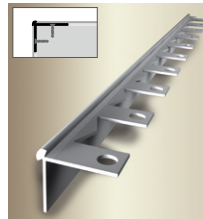
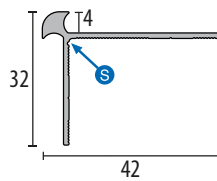

		5,0 m 2,5 m	SBS	EB
F2	F4		•	•

873 EB

EB = \varnothing min 100 cm

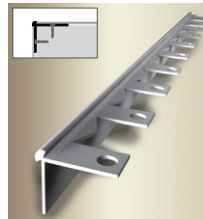
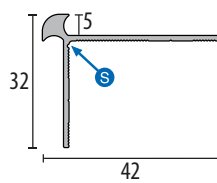

		5,0 m 2,5 m	SBS	EB
F2	F4		•	•

874 EB

EB = \varnothing min 150 cm

EB = \varnothing min 200 cm

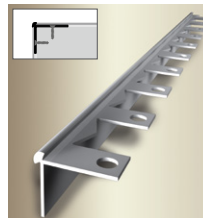
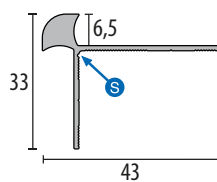

		5,0 m 2,5 m	SBS	EB
F2	F4		•	•

Preise finden Sie ab Seite / Prices are indicated on page 197

■ Biegbare T-Profil / Easy Bendable T Profiles

Artikel
article

290

Messing / Brass

EB = \varnothing min 40 cm

Aluminium / Aluminium

EB = \varnothing min 40 cm

Holzdekor / Wood Decor

EB = \varnothing min 40 cm

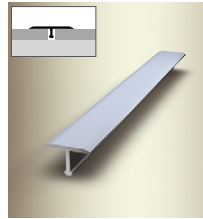
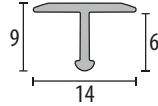

Edelstahl / Stainless Steel
nicht biegsam / unbendable

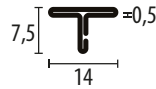

Farbe
colour

Länge
length

Version
version

F2G	F3	F4	F5	2,7 m	SBS	U	EB
F6	F7	F9			•	•	•
				Edelstahl / Stainless Steel			
H20	H22	H30	H31		2,5 m	•	•
H33	H34	H40	H61				
H62	H63	H64	H65				
H80	H81	H95					
F8	F8G	DIGITAL PRINT DECOR COATING by Küberit					

291

Aluminium / Aluminium

EB = \varnothing min 120 cm

Holzdekor / wood decor

EB = \varnothing min 120 cm

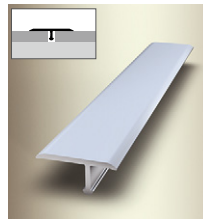
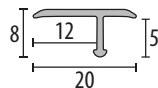

F2G	F3	F4	F5	2,7 m	SBS		EB
F6	F9				•		•
				Edelstahl / Stainless Steel			
H20	H22	H30	H31		2,5 m	•	•
H33	H34	H40	H61				
H62	H63	H64	H65				
H80	H81	H95					
F8	F8G	DIGITAL PRINT DECOR COATING by Küberit					

295

Aluminium / Aluminium

EB = \varnothing min 180 cm

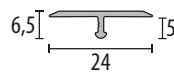

F2G	F3	F4	F5	2,7 m	SBS		EB
F6	F9				•		•
				Edelstahl / Stainless Steel			
H20	H22	H30	H31		2,5 m	•	•
H33	H34	H40	H61				
H62	H63	H64	H65				
H80	H81	H95					
F8	F8G	DIGITAL PRINT DECOR COATING by Küberit					

Preise finden Sie ab Seite / Prices are indicated on page 197



© Küberit

■ Biegbare T-Profil / Easy Bendable T Profiles

Artikel
article

293

Aluminium / Aluminium

EB = Ø min 400 cm

Holzdekor / wood decor

EB = Ø min 400 cm

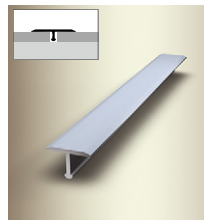
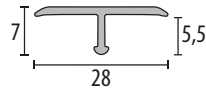

Farbe
colour

Länge
length

Version
version

				2,7 m	SBS	EB
F2G	F3	F4	F5		•	•
F6	F9					
H20	H22	H30	H31			
H33	H34	H40	H61			
H62	H63	H64	H65			
H80	H81	H95				



Preise finden Sie ab Seite / Prices are indicated on page 198

Zubehör / Accessories

Lamellendübel für T-Profile
Rib Dowels for T-profiles

Ø 6 mm,
14 Stück pro Blisterkarte
Ø 6 mm
14 pieces per blisterboard

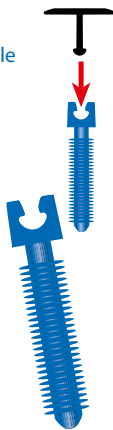

Preise finden Sie ab Seite /
Prices are indicated on page 198

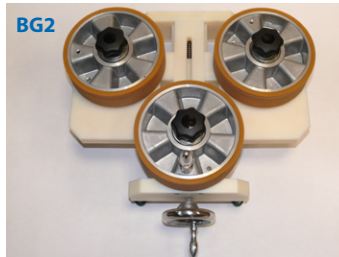

Biegemaschine für biegbare Treppenkantenprofile mit 3 großen Rollen - auch als Umbauset erhältlich / Bending machine for stair nosings with 3 large wheels. Also available as a set to change the rolls



Biegemaschinen (Preis auf Anfrage)
Bending Machines (Price on request)

Mit unserer robusten Küberit-Biegemaschine lassen sich schnell und einfach Radien und Bögen vor Ort professionell erstellen. In Kombination mit unseren speziellen EB-Profilen bieten wir Ihnen neue gestalterische Möglichkeiten. Lassen Sie Ihrer Fantasie freien Lauf. Gestalten Sie Ihre Anschlüsse für textile, elastische und keramische Bodenbeläge jetzt mit Rundungen nach Ihren Vorstellungen.

Create curves and set highlights quickly and easily onsite with our high-grade bending machine. With our special Easy Bendable Profiles, we offer you new creative possibilities. Be original and design your own connection for carpet, resilient and ceramic floor coverings according to your ideas.

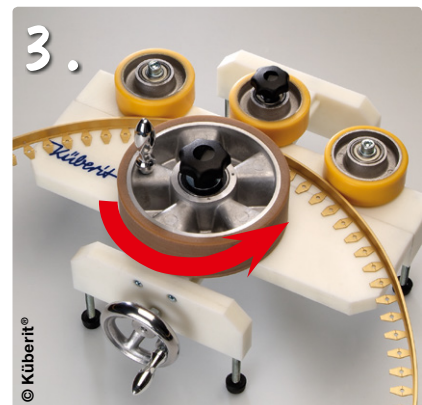
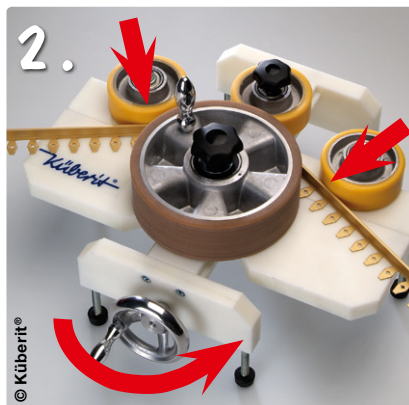
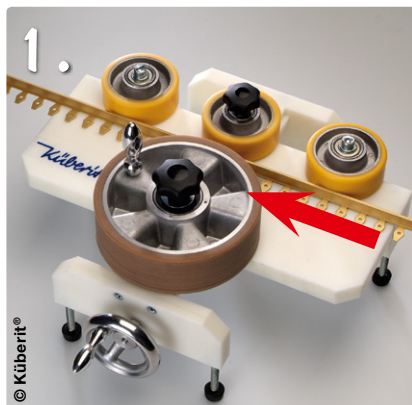

Preis auf Anfrage / Price upon request



© Küberit®

295



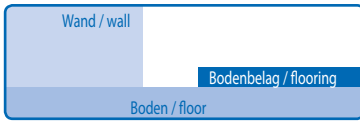

Wand-, Tapetenprofile und Eckschutzwinkel

Wallpaper Profiles and Corner Guards



Best-Profile

- **Wand-, Tapetenprofile und Eckschutzwinkel**
Wallpaper Profiles and Corner Guards









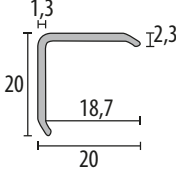
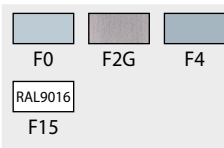
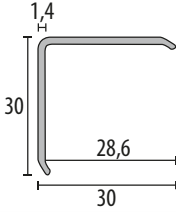
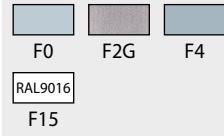
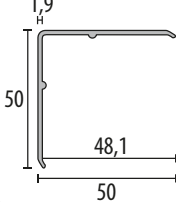

Für Maler und Raumausstatter bietet der Einsatz unserer **Küberit-Wandprofile** und **Tapetenprofile** ein enormes Potenzial zur Zeitersparnis beim Tapezieren, da eine einfache und schnelle Fertigstellung von zu tapezierenden Wandaußen- und -innenecken und eine elegante Verbindung von Übergängen möglich ist. Als dauerhafter Kantenschutz sind die Wandaußenecken auch ein hochwertiges und dekoratives Element für aufwendig gestaltete Wände mit edlen Wandbelägen. Durch die **Küberit-Wandprofile** wird zudem das Tapezieren auf Stoß erleichtert, da saubere Schnittkanten am strapazierfähigen Aluminiumprofil entlang problemlos vorgenommen werden können. Außerdem sind sie ein robuster Kantenschutz und lassen eine dekorative Verbindung von Übergängen zu. Durch den Einsatz von unseren **Küberit-Wandprofilen** erhalten Wandgestaltungen eine einzigartige Optik, die z. B. bei sehr aufwendigen Gestaltungen mit unterschiedlichen Tapetenmustern gewünscht wird.

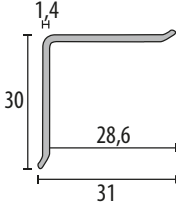
Küberit verfügt ebenfalls über ein umfangreiches Sortiment an Außen- und Innen-**Eckschutzwinkeln** aus Aluminium und Edelstahl, die vorwiegend im Objektbau wie z.B. in Hotels, Großküchen, Krankenhäusern, Seniorenresidenzen etc. zum Einsatz kommen und überall dort, wo Raumecken vor Beschädigungen durch Betten, Transportwagen oder Ähnlichem auch nachträglich geschützt werden sollen. Die **Eckschutzwinkel** dienen einem effektiven Aufprallschutz und der dekorativen Gestaltung.

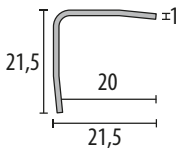
Our **Küberit Wallpaper Profiles** will help professional painters and room fitters save time installing wallcoverings. The wallcoverings can easily be installed on outside and inside corners and wallcovering lines or panels can be elegantly connected. The outside corner has a long lasting protection but is also a decorative element for elaborately designed walls with noble wallcoverings. **Küberit Wallpaper Profiles** make it much easier and faster to install wallcoverings from edge-to-edge since they can be easily cut at the edge of a solid aluminium profile ensuring a neat border. These profiles also serve as solid corner protection and decorative connection for wallpaper. With **Küberit Wallpaper Profiles** it is possible to create a unique design.

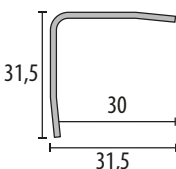
The **Küberit** assortment includes internal and external **Corner Guards** made of aluminium and stainless steel, which are predominantly used by hotels, canteen kitchens, hospitals and retirement communities and anywhere room corners need to be protected from damages caused by beds, transport carts or similar. The **Corner Guards** act as an effective impact protection but also have a decorative design. A combination of two different wallcoverings is no longer a problem.

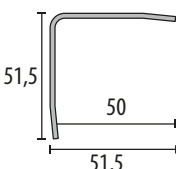
■ Eckschutzwinkel mit Schutzfolie / Corner Guards with Protective Film

Artikel article		Farbe colour	Länge length	Version version
271 <i>ungebohrt oder selbstklebend</i> <i>undrilled or self-adhesive</i>			2,5 m 5,0 m	U SK ¹ • • •*
<small>¹ SK dient als Montagehilfe! / SK only as an assembling aid! * nicht für/not for F15</small>				
273 <i>ungebohrt oder selbstklebend</i> <i>undrilled or self-adhesive</i>			2,5 m 5,0 m	U SK ¹ • • •*
<small>¹ SK dient als Montagehilfe! / SK only as an assembling aid! * nicht für/not for F15</small>				
275 <i>ungebohrt oder selbstklebend</i> <i>undrilled or self-adhesive</i>			2,5 m 5,0 m	U SK ¹ • • • •
<small>¹ SK dient als Montagehilfe! / SK only as an assembling aid!</small>				
283 <i>ungebohrt oder selbstklebend</i> <i>undrilled or self-adhesive</i>			2,5 m 5,0 m	U SK ¹ • • • •
<small>¹ SK dient als Montagehilfe! / SK only as an assembling aid!</small>				
272 U <i>ungebohrt, 3-fach gekantet</i> <i>undrilled, 3-side edged</i> V2A			2,5 m	U •
274 U <i>ungebohrt, 3-fach gekantet</i> <i>undrilled, 3-side edged</i> V2A			2,5 m	U •
276 U <i>ungebohrt, 3-fach gekantet</i> <i>undrilled, 3-side edged</i> V2A			2,5 m	U •

Preise finden Sie ab Seite / Prices are indicated on page 198

■ Eckschutzwinkel mit Schutzfolie / Corner Guards with Protective Film

Artikel
article

Farbe
colour

Länge
length

Version
version

542 U

ungebohrt, 1-fach gekantet
undrilled, 1-side edged
V2A

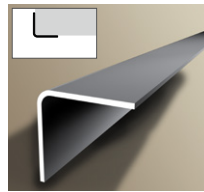
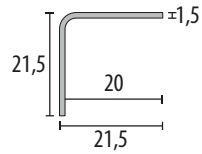

 F8G	2,5 m	U	•
---	-------	---	---

543 U

ungebohrt, 1-fach gekantet
undrilled, 1-side edged
V2A

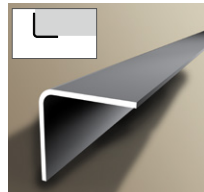
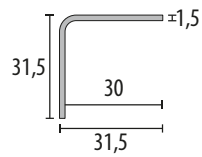

 F8G	2,5 m	U	•
---	-------	---	---

Preise finden Sie ab Seite / Prices are indicated on page 198



© Küberit®

■ Eckschutzwinkel mit Schutzfolie / Corner Guards with Protective Film

Artikel
article

Farbe
colour

Länge
length

Version
version

142

ungebohrt, selbstklebend
und als 45°-Krone
undrilled, self-adhesive
and as 45°-crown
1-fach gekantet, 1-side edged
V2A

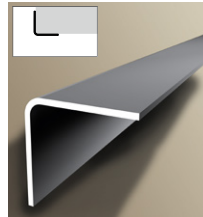
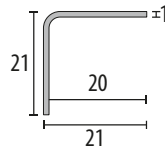

F8G	1,25 m	U	U-K	SK'	SK'-K
	1,5 m	•	•	•	•
	2,5 m	•	•	•	•
		•		•	

¹ SK dient als Montagehilfe! / SK only as an assembling aid!

143

ungebohrt, selbstklebend
und als 45°-Krone
undrilled, self-adhesive
and as 45°-crown
1-fach gekantet, 1-side edged
V2A

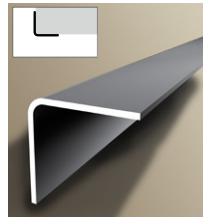
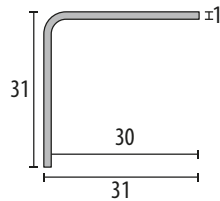

F8G	1,25 m	U	U-K	SK'	SK'-K
	1,5 m	•	•	•	•
	2,5 m	•	•	•	•
		•		•	

¹ SK dient als Montagehilfe! / SK only as an assembling aid!

172

ungebohrt, selbstklebend
und als 45°-Krone
undrilled, self-adhesive
and as 45°-crown
3-fach gekantet, 3-side edged
V2A

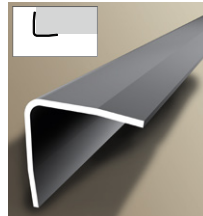
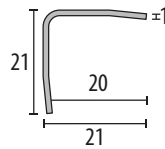

F8G	1,25 m	U	U-K	SK'	SK'-K
	1,5 m	•	•	•	•
	2,5 m	•	•	•	•
		•		•	

¹ SK dient als Montagehilfe! / SK only as an assembling aid!

174

ungebohrt, selbstklebend
und als 45°-Krone
undrilled, self-adhesive
and as 45°-crown
3-fach gekantet, 3-side edged
V2A

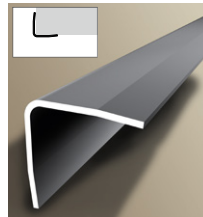
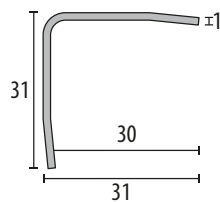

F8G	1,25 m	U	U-K	SK'	SK'-K
	1,5 m	•	•	•	•
	2,5 m	•	•	•	•
		•		•	

¹ SK dient als Montagehilfe! / SK only as an assembling aid!

Preise finden Sie ab Seite / Prices are indicated on page 199



U-K =
ungebohrt mit Krone
undrilled with crown

SK-K =
selbstklebend mit Krone
self-adhesive with crown

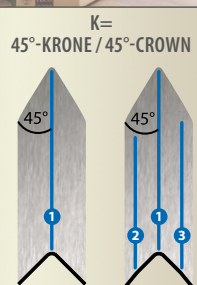

Wand- und Tapetenprofile / Wallpaper Profiles

Artikel
article

Farbe
colour

Länge
length

Version
version

299

ungebohrt oder
geschlossen gestanzt
undrilled or
close punched

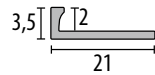

				2,5 m	SBS	U	G
F0	F2	F3	F4		•	•	•
F5	F6	F9					
F15	F16						

355

versenkt gebohrt
countersunk drilled

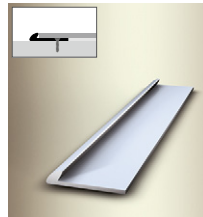
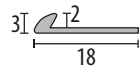

			2,5 m	SBS	V	RAL
F2	F4	F5		•	•	•
F15	F16					

365

versenkt gebohrt,
für CV- und PVC-Böden
countersunk drilled,
for CV and PVC floorings

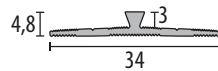

			3,0 m	SBS	V	RAL
F2	F4	F5		•	•	•
F15	F16					

Preise finden Sie ab Seite / Prices are indicated on page 199



© Küberit®

Wand- und Tapetenprofile mit Schutzfolie / Wallpaper Profiles with Protective Film

Artikel
article

Farbe
colour

Länge
length

Version
version

150

ungebohrt oder
geschlossen gestanzt
undrilled or
close punched

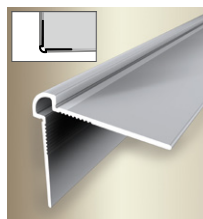
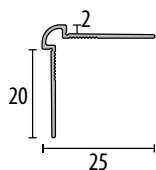

			2,7 m	SBS •	U •	G •
F2G	F4	F5				
F15	F16					

155

ungebohrt oder
geschlossen gestanzt
undrilled or
close punched

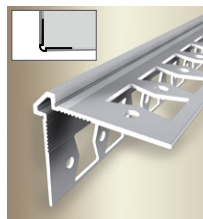
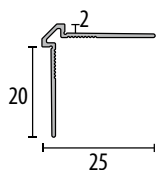

			2,7 m	SBS •	U •	G •
F2G	F4	F5				
F15	F16					

160

ungebohrt oder
geschlossen gestanzt
undrilled or
close punched

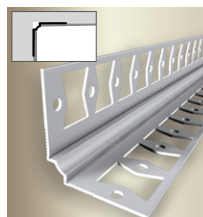
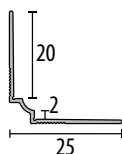

			2,7 m	SBS •	U •	G •
F2G	F4	F5				
F15	F16					

170

ungebohrt oder
geschlossen gestanzt
undrilled or
close punched

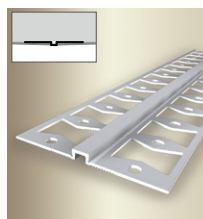
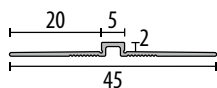

			2,7 m	SBS •	U •	G •
F2G	F4	F5				
F15	F16					

Preise finden Sie ab Seite / Prices are indicated on page 199



■ Wand- und Tapetenprofile / Wallpaper Profiles



© Küberit®

VIDEO



kueberit.com/qr/wand



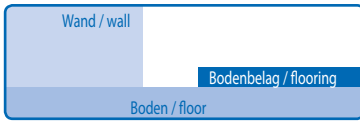

Aluminium-Sockelleisten »Deco Base Board«

Aluminium Skirtings »Deco Base-Board«



Best-Profile

- Aluminium-Sockelleisten »Deco Base Board«
Aluminium Skirtings »Deco Base-Board«

Fußbodenbeläge werden heute in unterschiedlichsten Designs angeboten. *Küberit* hat sich auf diese Vielfalt eingestellt und bietet ein umfangreiches Angebot an hochwertigen **Sockelleisten** aus Aluminium und Edelstahl für Parkett, Laminat, elastische Beläge oder Teppichböden. Das Lieferprogramm reicht von der einteiligen bis hin zur zweiteiligen Sockelleiste, hochwertig gefertigt und auf die Bedürfnisse der Endverbraucher abgestimmt.

Floor coverings are offered in many different designs. *Küberit* is prepared for this variety and offers a large assortment of high-quality aluminium and stainless steel **skirtings** for parquet, laminate, elastic floor coverings and wall-to-wall carpets. The high-quality range of one-part and two-part **skirtings** was developed according to the demands of end-users.



■ System-Sockelleisten 938, 935, 936 und 934 zum Clippen System Skirtings 938, 935, 936 and 934 to clip

- mit Verbinder, Ecken- und Endstücken bei den Typen 938, 935, 936 und 934
- leichte und zeitsparende Verlegung
- formschönes Design in edler Optik
- drei Kabelkanäle
- leichte Demontage
- lieferbar in Aluminium eloxiert silber und edelstahl mit fein geschliffener Oberfläche
- with connecting units, corners and end caps for types 938, 935, 936 and 934
- easy and time-saving installation
- beautiful and elegant design
- three cable channels
- easy to remove
- available in anodized aluminium, silver and stainless steel brushed

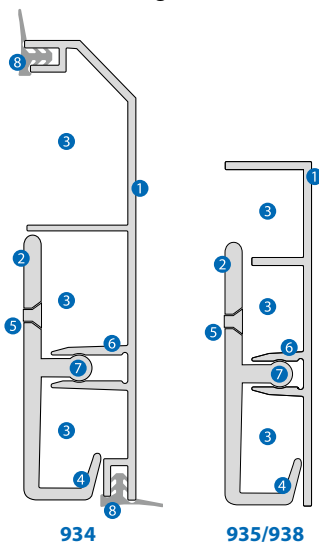

1. Hochwertige Sockelleiste / high-quality baseboard
2. Wandhalter aus Glasfaser / fixing bracket made of glass fibre
3. Kabelkanal / cable conduct
4. Spannfeder / tension spring
5. Befestigung (Verdübelung oder Verschraubung) / fastening (anchor or screw)
6. Clip-Steg / clip edge
7. Gegensteg mit Gelenk / limit-edge with joint
8. Dichtlippe / sealing lip

Verbinder, Ecken und Endstücke sind einzeln lieferbar /
Connectors, corners and end caps are available separately

■ Aluminium-Sockelleiste »Decolino« für Designbeläge (945 U)
Aluminium Skirtings »Decolino« for Design Floor Coverings (945 U)



- patentierte Aluminium-Sockelleiste mit 3 mm Einschub
- beidseitig einsetzbar
- zur Befestigung wird ein hochwertiges Klebeband angeboten
- patented aluminium skirtings board with 3 mm slot
- can be installed from either side
- a high-quality adhesive tape for the fixation is available



■ Sockelleiste 910, 911, 912 und 913 - selbstklebend und ungebohrt
Skirtings 910, 911, 912 and 913 - self-adhesive and undrilled

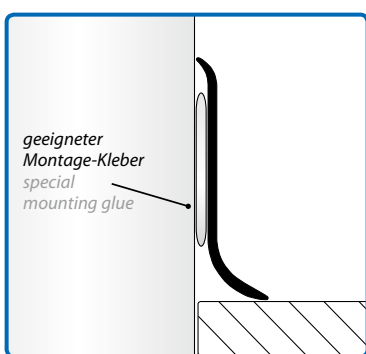

Die ungebohrten Sockelleisten werden mit einem geeigneten Montagekleber optimal befestigt. Auf Wunsch sind auch Abstandhalter lieferbar, die eine Kabelverlegung bis 8 mm Durchmesser ermöglichen.

The undrilled skirtings can be secured with an appropriate assembly adhesive. Distance pieces are available on request and cables with a diameter up to 8 mm can be covered.

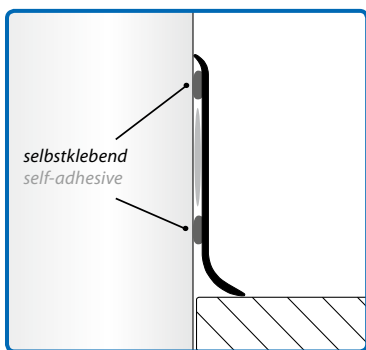

Die selbstklebenden Sockelleisten lassen sich sehr leicht verlegen: zuschneiden, Schutzfolie abziehen, andrücken, fertig! SK-Ausführung dient nur als Montagehilfe! The self-adhesive skirtings are easy to install: trim, pull off the protection foil, press on, finished! Adhesive serves only as an installation support and an additional appropriate adhesive needs to be applied.

■ Aluminium-Sockelleisten / Aluminium Skirtings

Artikel
article

Farbe
colour

Länge
length

Version
version

938

inkl. 7 Wandhalter,
Schrauben und Dübel
incl. 7 fixing bracket,
screws and anchors

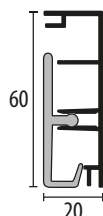

	2,5 m	SBS • U •	
--	-------	--------------------	--

938 D

inkl. Dichtlippen,
7 Wandhalter,
Schrauben und Dübel
incl. sealing lips,
7 fixing bracket,
screws and anchors

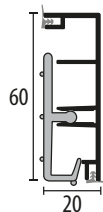

	2,5 m	SBS • U •	
--	-------	--------------------	--

Preise finden Sie auf Seite / Prices are indicated on page 199

Aluminium-Sockelleisten / Aluminium Skirtings

Artikel article

935

inkl. 7 Wandhalter,
Schrauben und Dübel
incl. 7 fixing brackets,
screws and anchors

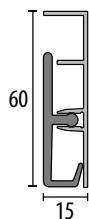

Farbe colour

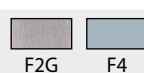

Länge length

2,5 m

Version version

SBS U
• •



936

inkl. 7 Wandhalter,
Schrauben und Dübel
incl. 7 fixing brackets,
screws and anchors

LED Zubehör / Accessories S. 55

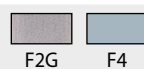
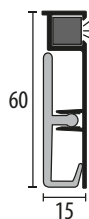

2,5 m

SBS U
• •



950

»Decostar«

inkl. Feder, Schrauben und Dübel
incl. feather, screws and anchors

⇔ 2 – 11 mm ⇕ 45 mm

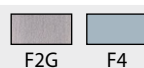
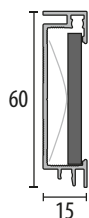

2,5 m

SBS V
• •

950 D

»Decostar«

inkl. Dichtlippen,
Feder, Schrauben und Dübel
incl. sealing lips, feather,
screws and anchors

⇔ 2 – 11 mm ⇕ 45 mm

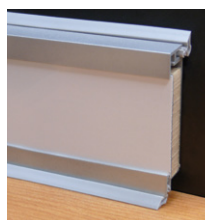
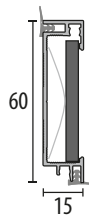

2,5 m

SBS V/D
• •

934

inkl. 7 Wandhalter,
Schrauben und Dübel
incl. 7 fixing brackets,
screws and anchors

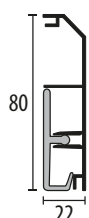

2,5 m

SBS U
• •



934 D

inkl. Dichtlippen,
7 Wandhalter,
Schrauben und Dübel
incl. sealing lips,
7 fixing bracket,
screws and anchors

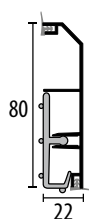

2,5 m

SBS U/D
• •



Preise finden Sie ab Seite / Prices are indicated on page 199

■ Aluminium-Sockelleisten / Aluminium Skirtings

Artikel
article

Farbe
colour

Länge
length

Version
version

945 U

»Decolino«
ungebohrt,
beidseitig montierbar
»Decolino«
undrilled, installation
possible from either side

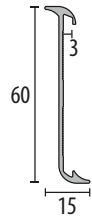

		2,5 m	SBS	U
			•	•



927 U

ungebohrt
undrilled

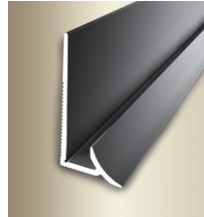
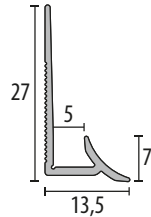

		2,5 m	SBS	U
			•	•

Preise finden Sie ab Seite / Prices are indicated on page 199

Zubehör / Accessories

Aluminium End- und Eckstücke
Aluminium end caps and corners

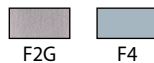

934 D² 935/936/938¹



Endstück, links und rechts
end cap, left and right

90° Außenecke
90° external corner

90° Innenecke
90° internal corner

Verbinder
connector

135° Außenecke
135° external corner

135° Innenecke
135° internal corner

938 D/950/950 D¹

¹ 135° Ecken nur für
934 D, 935 und 936!
135° Corners for
934 D, 935 und 936!

² Diese Formteile können nur beim Typ
934 D mit Dichtlippe eingesetzt werden!
* These accessories can only be used
for type 934 D with sealing lip!

945 U



Wandhalter 931
Fixing brackets 931

für Typ 938, 935, 936 und 934
for type 938, 935, 936 and 934



Kunststoff End- und Eckstücke in silber und edelstahloptik
Plastic end caps and corners in silver and stainless steel optic

912/913



Wandhalter 931 D
Fixing brackets 931 D

für Typ 934 D und 938 D
for type 934 D and 938 D



Kleband / Adhesive tape

zur Befestigung der Sockelleiste 945 U »Decolino«
for installing skirting 945 U »Decolino«

10 m Rolle/roll



Abstandhalter aus Kunststoff
Plastic distance piece

für Typ 910, 911, 912 und 913
for type 910, 911, 912 and 913

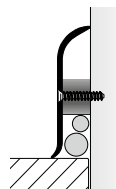

Preise finden Sie ab Seite / Prices are indicated on page 200

■ Aluminium-Sockelleisten / Aluminium Skirtings

Artikel
article

Farbe
colour

Länge
length

Version
version

910
ungebohrt oder selbstklebend,
beidseitig montierbar
undrilled or self-adhesive,
installation possible
from either side
EB (U) = Ø min 50 cm

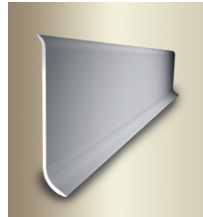
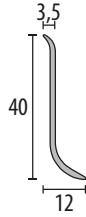

 F2G	 F4	2,5 m	SBS	U	SK
			•	•	•
					

911
ungebohrt oder selbstklebend,
beidseitig montierbar
undrilled or self-adhesive,
installation possible
from either side
EB (U) = Ø min 50 cm

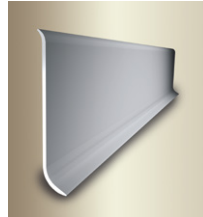
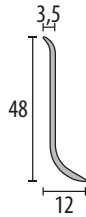

 F2G	 F4	2,5 m	SBS	U	SK
			•	•	•
					

912
ungebohrt oder selbstklebend,
beidseitig montierbar
undrilled or self-adhesive,
installation possible
from either side
EB (U) = Ø min 50 cm

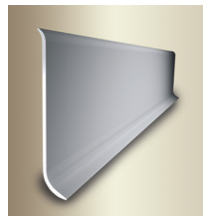
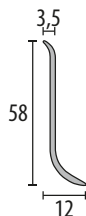

 F2G	 F4	2,5 m	SBS	U	SK
			•	•	•
					



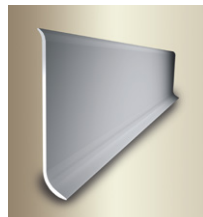
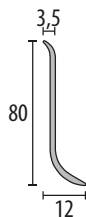

913
ungebohrt oder selbstklebend,
beidseitig montierbar
undrilled or self-adhesive,
installation possible
from either side
EB (U) = Ø min 50 cm

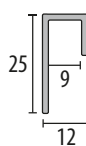

 F2G	 F4	2,5 m	SBS	U	SK
			•	•	•
					

901
versenkt gebohrt
countersunk drilled



 F2G	 F4	5,0 m	SBS	V	
		2,5 m	•	•	
					
 3,0					

Preise finden Sie ab Seite / Prices are indicated on page 199

■ Edelstahl-Sockelleisten / Stainless Steel Skirtings

916 U
ungebohrt
undrilled

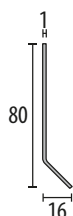

 F8G		2,5 m	SB	U	
			•	•	

917 U
ungebohrt
undrilled

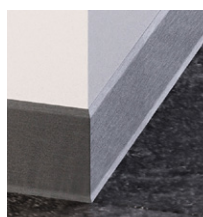
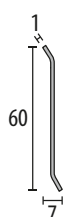

 F8G		2,5 m	SB	U	
			•	•	

Preise finden Sie ab Seite / Prices are indicated on page 199

■ Aluminium-Sockelleisten / Aluminium Skirtings

Zubehör / Accessories

AUßENECKE EXTERNAL CORNER



INNENECKE INTERNAL CORNER

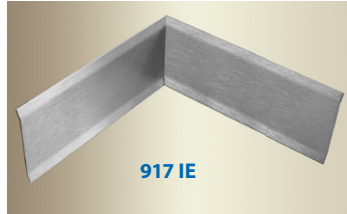

F8G	15	SB	U		
	x	•	•		
	15				
	cm				

Preise finden Sie ab Seite / Prices are indicated on page 199



© Küberit®

912



TORX!

PPS®-Champion Star

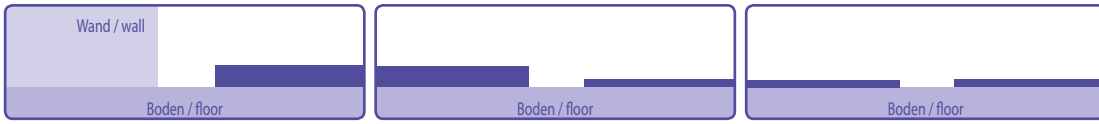

PPS[®]-Champion Star



PPS[®]-Champion **Star**

Das Küberit **PPS[®]-Champion Star** – das wohl schmalste Schraub-Profilsystem – wurde für die Verlegung von unterschiedlich starken LVT-Böden mit einer Bodenbelagsstärke von 4 bis 9,5 mm oder für hochwertige Teppichböden von 5 bis 12 mm entwickelt. Das technisch innovative Profilsystem steht in dezenter optischer Ausführung als Abschluss-, Übergangs- und Anpassungsprofil zur Verfügung und wird in den 5 bekannten Aluminium-Farbtönen angeboten.

The Küberit **PPS[®]-Champion Star** – probably the narrowest screw profile system – was developed for LVT floors with a thicknesses of 4 to 9.5 mm or for high grade carpeting of 5 to 12 mm. This technically innovative profile system with its discreet design is available as a border, connecting or adapting profile in the 5 anodized colours.

■ PPS®-Champion Star

Das wohl schmalste Schraub-Profilssystem für LVT-Designbeläge und Teppichböden

- für Designbeläge von 4 – 9,5 mm
- für Teppichböden bis zu 12 mm
- wohl schmalstes Schraub-Profilssystem weltweit
- Champion-Technologie mit Verschiebenut
- formschönes TOP-Profil mit geringer Aufbauhöhe
- Einsatz von hochwertigen TORX-Schrauben
- Verstärkung im gesenkten Bohrloch sorgt für eine optimale Befestigung
- das 40 mm breite BASIS-Profil ermöglicht eine seitlich versetzte Bohrung von der Estrichfuge oder eine größere Klebeauftragsfläche

erhältlich als:

ANPASSUNGSPROFIL (oder AUSGLEICHSPROFIL)
für alle Bodenbeläge an angrenzende, niedrigere Flächen oder Beläge

ABSCHLUSSPROFIL
für saubere Abschlüsse und Begrenzungen von Bodenbelägen vor höheren, angrenzenden Schwellen, Kacheln, Fliesen, Terrassentüren und -fenstern oder anderen Erhöhungen

ÜBERGANGSPROFIL (oder DEHNFUGENPROFIL)
für gleich hohe oder bis zu ± 3 mm unterschiedlich hohe Bodenbeläge

The possibly narrowest screw profile system for LVT floors and carpet floor coverings

- for LVT floors from 4 – 9.5 mm
- for carpet floors up to 12 mm
- possibly the narrowest screwable profile system worldwide
- Champion-technology with sliding grooves
- appealingly designed TOP profile with a flat buildup
- use of high quality TORX-screws
- reinforced countersunk bore-holes ensure optimum installation
- the 40 mm wide BASE profile allows a laterally offset drilling to the screed joint or a wider adhesive surface

available as:

ADAPTING PROFILE
(or LEVELING PROFILE / REDUCER PROFILE)
for all floor coverings bordering lower areas or floors

BORDER PROFILE
for neat borders of floor coverings in front of higher sills, tiles, terrace doors and windows or other raisings

CONNECTING PROFILE (or EXPANSION JOINT PROFILE)
for floor coverings of equal level or up to ± 3 mm difference in height



■ PPS®-Champion Star

Artikel
article

Farbe
colour

Länge
length

Version
version

376

für Designbeläge von
for LVT floor coverings from
⇄ 4–9,5 mm ◀▶ 8 mm

für Teppichböden von
for carpet floors from
⇄ 5–12 mm

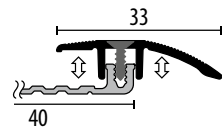

				0,9 m	SB	V		
F2	F4	F5	F6					
				1,0 m	•	•		
				2,7 m	•	•		
				3,0 m	•	•		
					2,9			

377

für Designbeläge von
for LVT floor coverings from
⇄ 4–9,5 mm ◀▶ 8 mm

für Teppichböden von
for carpet floors from
⇄ 5–12 mm

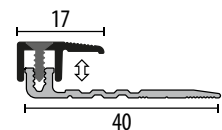

				0,9 m	SB	V		
F2	F4	F5	F6					
				1,0 m	•	•		
				2,7 m	•	•		
				3,0 m	•	•		
					2,9			

378

für Designbeläge von
for LVT floor coverings from
⇄ 4–9,5 mm ◀▶ 2x 8 mm

für Teppichböden von
for carpet floors from
⇄ 5–12 mm

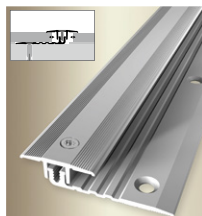
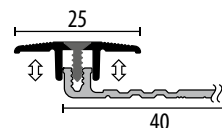

				0,9 m	SB	V		
F2	F4	F5	F6					
				1,0 m	•	•		
				2,7 m	•	•		
				3,0 m	•	•		
					2,9			

Preise finden Sie ab Seite / Prices are indicated on page 200



Zubehör / Accessories

PPS®-Lifter ⇄ 10–20 mm
aus glasfaserverstärktem Kunststoff (GFK),
zur Basisprofilerrhöhung
made of glass-fiber reinforced plastic (GFRP),
for lifting the BASE profile

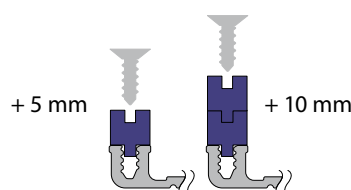

für / for
PPS®-Champion flex
PPS®-Champion / SK
PPS®-Champion smart
PPS®-Champion Star
PPS®-Allrounder
PPS®-AS
PPS®-Magic

Preise finden Sie auf Seite / Prices are indicated on page 203

■ PPS®-Champion Star Verlegeanleitung / Assembly Instruction

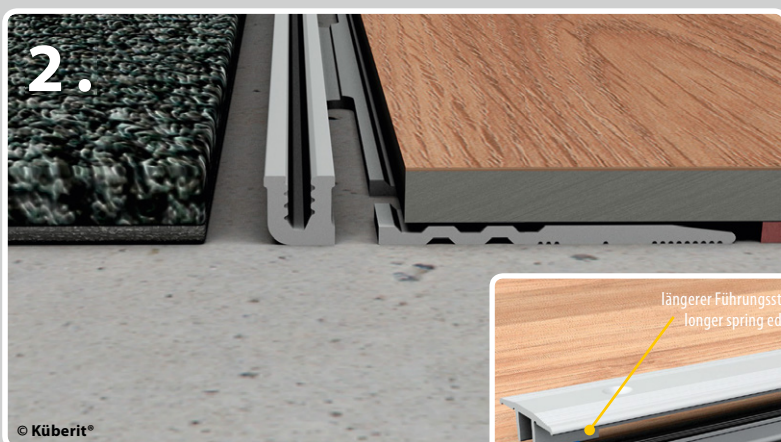
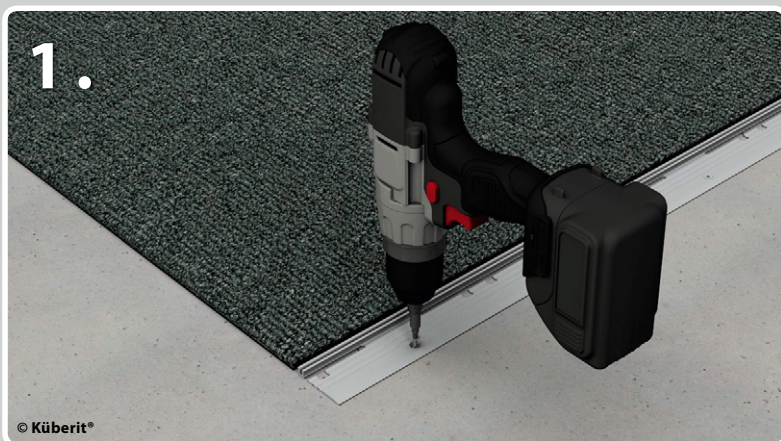

BASIS-Profil verdübeln und verschrauben (= Durchsteckmontage) bzw. bei Fußbodenheizung einen 2-Komponenten-Kleber verwenden.

Screw or anchor the **BASE profile** (= plug mounting). In case of underfloor heating, fasten the profile by using a two components adhesive.

Bodenbelag anpassen, dabei die vom Hersteller empfohlene **Dehnfuge** berücksichtigen!

Lay the floor covering and pay attention to the **expansion joint** as recommended by the flooring manufacturer!

Nur bei starken Bodenbelägen unter 5,5 mm auf die passgenaue Ausrichtung der längeren Schenkel vom **TOP-Profil** zur Verschiebenut des **BASIS-Profils** achten und **TOP-Profil** festschrauben.

For floor coverings of less than 5.5 mm thickness, make sure that the long side of the **TOP profile** is aligned with the sliding groove of the **BASE profile** and screw the **TOP profile**.

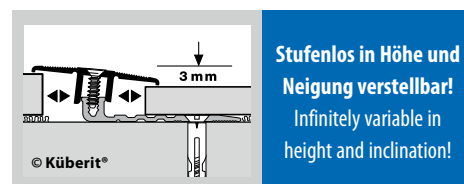

Höhendifferenzen mit wohldosierten Schlägen zwischen den Bohrlöchern anpassen. (Schlagklotz aus Hartholz und Filz)

Adjust height differences with well controlled hammer blows between the boreholes. (block of hardwood with felt)

Schrauben nachziehen!
Fertig ist die hochwertige Verlegung!

Afterwards retight all screws again!
The high-quality installation is finished!

VIDEO



kueberit.com/qr/chstar

■ PPS®-Champion Star



912, 378

© Kliberit®



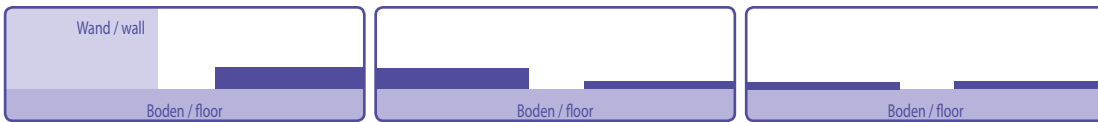

Design-Clip® / Design-Clip®XL



Design-Clip® XL

Für schwimmend verlegbare Design-Bodenbeläge bietet *Küberit* **Design-Clip®** an - ein zweiteiliges Clip-Profilsystem mit glatter Oberfläche und 6 mm Dehnfuge. Mit diesem Profilsystem erzielt der Profi-Verleger ein Höchstmaß an Zeitersparnis bei der Verlegung durch eine praktische und zugleich leicht händelbare Clip-Technik. Zudem erfüllt dies *Küberit* Clip-System auch bei hoher Beanspruchung ein Maximum an Stabilität durch den Kontersteg und die einzigartige 3-Punkt Verzahnung von Top- und Basisprofil. **Design-Clip®** eignet sich für die Verlegung von 4 – 7,5 mm starken Designböden oder 5 – 12 mm starken Teppichböden und ist lieferbar als Anpassungs-, Abschluss- und Übergangsprofil.

Ergänzt wurde das Sortiment mit dem Profilsystem **Design-Clip® XL** als optimale Verlegelösung mit größeren Dehnfugen bei schwimmend verlegten Böden. Zusätzlich zu den bekannten Vorteilen des Systems **Design-Clip®** bietet die XL-Variante 67% mehr Dehnfuge. Einsetzbar ist **Design-Clip® XL** für LVT-Designbeläge von 3,5 – 6,5 mm Höhe sowie für 4 – 11 mm starke Teppichböden.

Küberit developed **Design-Clip®** especially for floating Click Vinyl floorings – a 2-part profile system with a smooth surface that allows 6 mm expansion. Professional flooring installers can save time due to the practical and user-friendly click technology. Due to the counter edge and a 3-point indentation between the top and base profile, the *Küberit* Clip-System fulfills the highest mechanical demands. **Design-Clip®** is suitable for LVT floorings from 4 – 7.5 mm or for carpets from 5 – 12 mm and is available as adapting, border or connecting profile.

Introducing the new profile system **Design-Clip® XL** as the optimal solution for laying larger expansion joints on floating floors. In addition to the existing advantages of the original **Design-Clip®**, this new profile system has the capability of covering 67% more expansion joint. **Design-Clip® XL** can be used for LVT flooring of 3.5 – 6.5 mm in height as well as for carpet with a height of 4 – 11 mm.

■ Design-Clip®

Die optisch ansprechende Verlegelösung für LVT-Designbeläge und Teppichböden

- für LVT-Designbeläge von 4 – 7,5 mm
- für Teppichböden bis zu 12 mm
- bewährte Clip-Technik mit Kontersteg und 3-Punkt-Verzahnung
- einfache, zeitsparende und stabile Clip-Verbindung
- elegante glatte Oberflächen
- hochwertiger, individueller Digitaldruck möglich

The visually appealing installation solution for LVT floors and carpet flooring

- for LVT floors from 4 – 7.5 mm
- for carpet floors up to 12 mm
- approved clip-connection with counter edge and 3-point-interlock system
- easy, time-saving highly stable clip-connection
- elegant look due to a plain surface
- custom digital printing design available upon request

■ Design-Clip® XL

Die optimale Verlegelösung für größere Dehnfugen bei schwimmend verlegten Böden

- für LVT-Designbeläge von 3,5 – 6,5 mm
- für Teppichböden bis zu 11 mm
- mit bis zu 10 mm sind bei der XL-Variante 67% mehr Dehnfuge als beim Design-Clip® möglich

The optimal installation solution for floating floors with larger expansion joints

- for LVT floors from 3.5 – 6.5 mm
- for carpet flooring up to 11 mm
- compared to Design-Clip®, XL-Version allows 67% more expansion joint up to 10 mm

erhältlich als:

ANPASSUNGSPROFIL (oder AUSGLEICHSPROFIL)
für alle Bodenbeläge an angrenzende, niedrigere Flächen oder Beläge

ABSCHLUSSPROFIL
für saubere Abschlüsse und Begrenzungen von Bodenbelägen vor höheren, angrenzenden Schwellen, Kacheln, Fliesen, Terrassentüren und -fenstern oder anderen Erhöhungen

ÜBERGANGSPROFIL (oder DEHNFUGENPROFIL)
für gleich hohe oder bis zu ± 3 mm unterschiedlich hohe Bodenbeläge

available as:

ADAPTING PROFILE
(or LEVELING PROFILE / REDUCER PROFILE)
for all floor coverings bordering lower areas or floors

BORDER PROFILE
for neat borders of floor coverings in front of higher sills, tiles, terrace doors and windows or other raisings

CONNECTING PROFILE (or EXPANSION JOINT PROFILE)
for floor coverings of equal level or up to ± 3 mm difference in height



■ Design-Clip®

Artikel
article

Farbe
colour

Länge
length

Version
version

576

für Designbeläge von
for LVT floor coverings from
⇄ 4–7,5 mm ⇄ 6 mm

für Teppichböden von
for carpet floors from
⇄ 5–12 mm

glatte Oberfläche
smooth surface

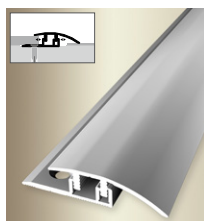
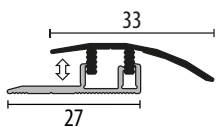

F2G	F4	F5	F6
F9			
H30	H33	H61	H62
H63	H64		

0,9 m	SB	U
1,0 m	•	•
2,7 m	•	•
3,0 m	•	•

577

für Designbeläge von
for LVT floor coverings from
⇄ 4–7,5 mm ⇄ 6 mm

für Teppichböden von
for carpet floors from
⇄ 5–12 mm

glatte Oberfläche
smooth surface

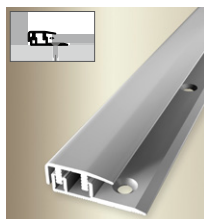
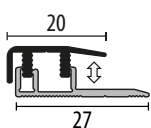

F2G	F4	F5	F6
F9			
H30	H33	H61	H62
H63	H64		

0,9 m	SB	U
1,0 m	•	•
2,7 m	•	•
3,0 m	•	•

578

für Designbeläge von
for LVT floor coverings from
⇄ 4–7,5 mm ⇄ 2x 6 mm

für Teppichböden von
for carpet floors from
⇄ 5–12 mm

glatte Oberfläche
smooth surface

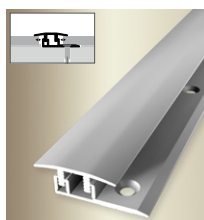
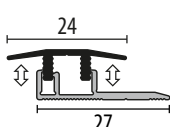

F2G	F4	F5	F6
F9			
H30	H33	H61	H62
H63	H64		

0,9 m	SB	U
1,0 m	•	•
2,7 m	•	•
3,0 m	•	•

Preise finden Sie ab Seite / Prices are indicated on page 201



■ Design-Clip® Verlegeanleitung / Assembly Instruction



BASIS-Profil verschrauben oder verdübeln (= Durchsteckmontage) bzw. bei Fußbodenheizung einen 2-Komponenten-Kleber verwenden.

Screw or anchor the **BASE profile** (= plug mounting). In case of underfloor heating, fasten the profile by using a two component adhesive.

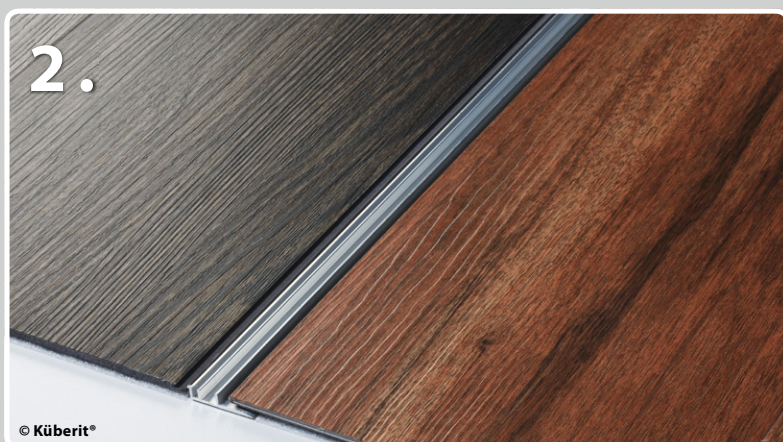

Bodenbelag anpassen, dabei die vom Hersteller empfohlene **Dehnfuge** berücksichtigen!

Lay the floor covering and pay attention to the **expansion joint** as recommended by the flooring manufacturer!

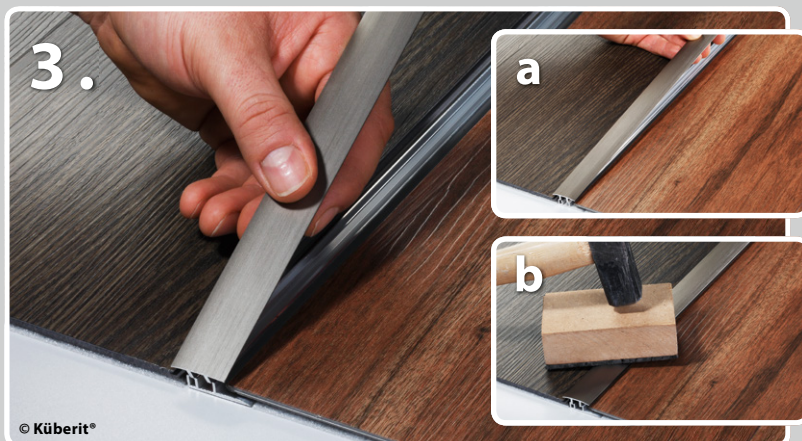

TOP-Profil vorsichtig auf das **BASIS-Profil** aufsetzen, eventuell noch in die richtige Position korrigieren.

Place the **TOP profile** carefully on the **BASE profile**, first bringing it into the correct position.

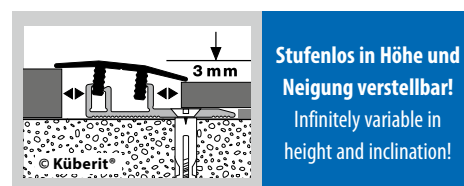

Höhendifferenzen mit wohldosierten Schlägen anpassen. (Schlagklotz aus Hartholz mit Filz). Fertig ist die hochwertige Verlegung!

Adjust height differences with well controlled hammer blows. (block of hardwood with felt). The high-quality installation is finished!

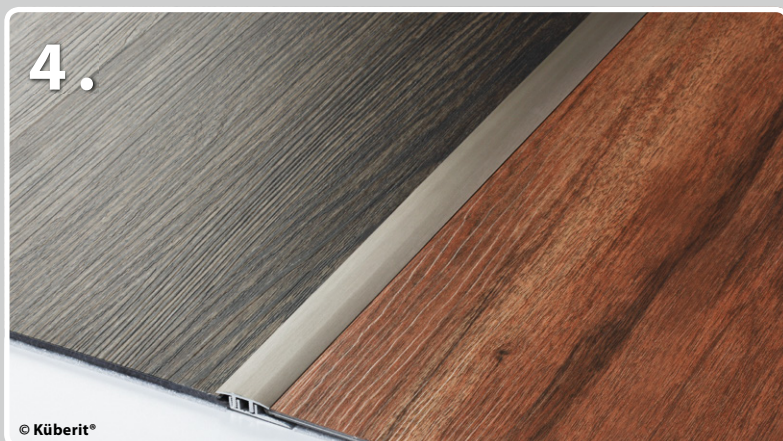

VIDEO



kueberit.com/qr/dclip

■ Design-Clip® XL breites TOP-Profil / Wide TOP Profile

Artikel
article

Farbe
colour

Länge
length

Version
version

576 XL

für Designbeläge von
for LVT floor coverings from
⇄ 3,5–6,5 mm ◀▶ 10 mm

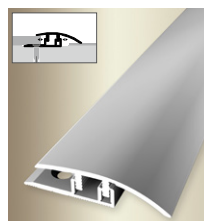
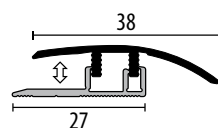

Farbe	Länge	Version
F2G	1,0 m	SB
F4	2,0 m	U
F6	3,0 m	
F9		

für Teppichböden von
for carpet floors from
⇄ 4–11 mm

577 XL

für Designbeläge von
for LVT floor coverings from
⇄ 3,5–6,5 mm ◀▶ 10 mm

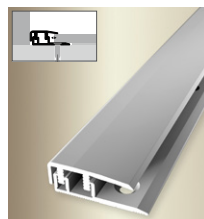
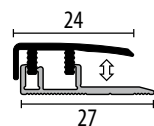

Farbe	Länge	Version
F2G	1,0 m	SB
F4	2,0 m	U
F6	3,0 m	
F9		

für Teppichböden von
for carpet floors from
⇄ 4–11 mm

578 XL

für Designbeläge von
for LVT floor coverings from
⇄ 3,5–6,5 mm ◀▶ 2x 10 mm

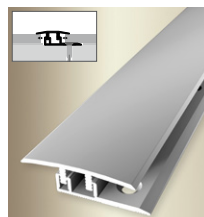
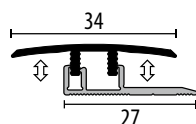

Farbe	Länge	Version
F2G	1,0 m	SB
F4	2,0 m	U
F6	3,0 m	
F9		

für Teppichböden von
for carpet floors from
⇄ 4–11 mm

Preise finden Sie ab Seite / Prices are indicated on page 202

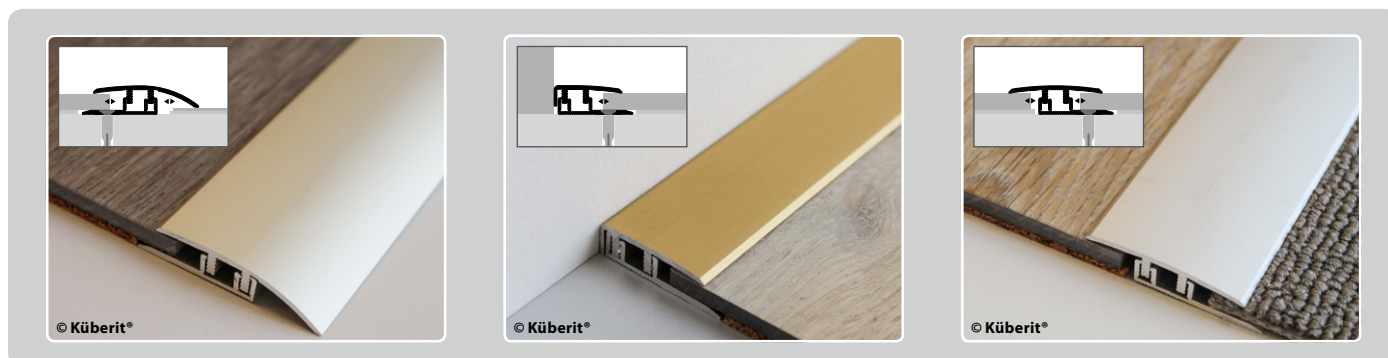

Das Profilsystem Design-Clip XL ist mit Holzdekoren nur in Verbindung mit einem Rahmenauftrag lieferbar!
Individuelle Dekore mit unserer Digitaldruck-Technik sind ebenfalls nur mit Rahmenauftrag möglich!

The profile system Design-Clip XL is available with wood decors only with a blanket order!
Individual decors made with our digital printing technology are possible!



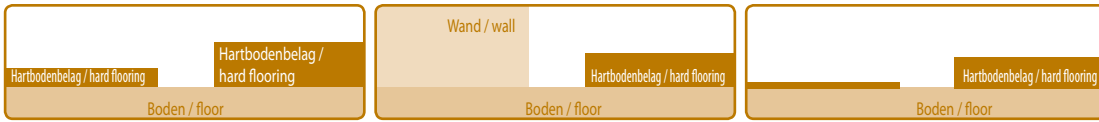

PPS[®]-Champion flex



PPS[®]-Champion **flex**

Das hochwertige Parkett- und Laminat-Profilsystem **PPS[®]-Champion flex** ist universell einsetzbar. Dieses System zeichnet sich durch ein einzigartiges, patentiertes Gelenk aus, das für eine optimale Neigungsverstellung des Abdeckprofils sorgt. Das dreiteilige Profilsystem gleicht bei unterschiedlichen Bodenbelagsarten automatisch und stufenlos Höhenunterschiede bis zu 12 mm aus! Die Schraubenköpfe schließen auch bei starker Neigung mit dem Trägerprofil plan ab und gewährleisten jederzeit eine optimale Positionierung. Bei gleich hohen Übergängen ist **PPS[®]-Champion flex** für alle Hartbodenbeläge von 7–17 mm verwendbar.

PPS[®]-Champion flex is a high-quality all-purpose profile system for parquet and laminate. The system is characterized by a new and unique joint that ensures an optimal inclination adjustment of the cover profile. The three-part profile system is infinitely variable and automatically levels differences in height up to 12 mm. Even in case of a high incline the screw head fits perfectly to the carrier profile and an ideal positioning is ensured at all times. In case of equally high hard floor coverings, **PPS[®]-Champion flex** is suitable for floors of 7–17 mm.

■ PPS®-Champion flex

Ein System für alle Hartböden.

- patentiertes Profilsystem mit einzigartigem flex-Gelenk
- automatisch in Höhe und Neigung anpassbar
- Übergangsprofil kann Höhenunterschiede von bis zu 12 mm ausgleichen
- 14 mm breite Dehnfugen möglich
- Einsatz von hochwertigen TORX-Schrauben
- Die Verstärkung im gesenkten Bohrloch sorgt für einen sicheren Sitz der TORX-Schrauben

erhältlich als:

ANPASSUNGSPROFIL (oder AUSGLEICHSPROFIL)

für alle Hartbodenbeläge an angrenzende, niedrigere Flächen oder Beläge

ABSCHLUSSPROFIL

für saubere Abschlüsse und Begrenzungen von Hartbodenbelägen vor höheren, angrenzenden Schwellen, Kacheln, Fliesen, Terrassentüren und -fenstern oder anderen Erhöhungen

ÜBERGANGSPROFIL (oder DEHNFUGENPROFIL)

für gleich hohe oder bis zu ± 12 mm unterschiedlich hohe Hartbodenbeläge

One system for all hard floorings.

- patented profile system with unique flex joint
- automatical adjustment in height and inclination
- Adapting profile can balance differences in height of up to 12 mm
- possibility of 14 mm expansion joints
- use of high-quality TORX-screws
- the reinforced drill hole provides a secure fit of the TORX-screws

available as:

ADAPTING PROFILE

(or LEVELING PROFILE / REDUCER PROFILE)

for all hard floor coverings bordering lower areas or floors

BORDER PROFILE

for neat borders of hard floor coverings in front of higher sills, tiles, terrace doors and windows or other raisings

CONNECTING PROFILE (or EXPANSION JOINT PROFILE)

for hard floor coverings of equal level or up to ± 12 mm difference in height

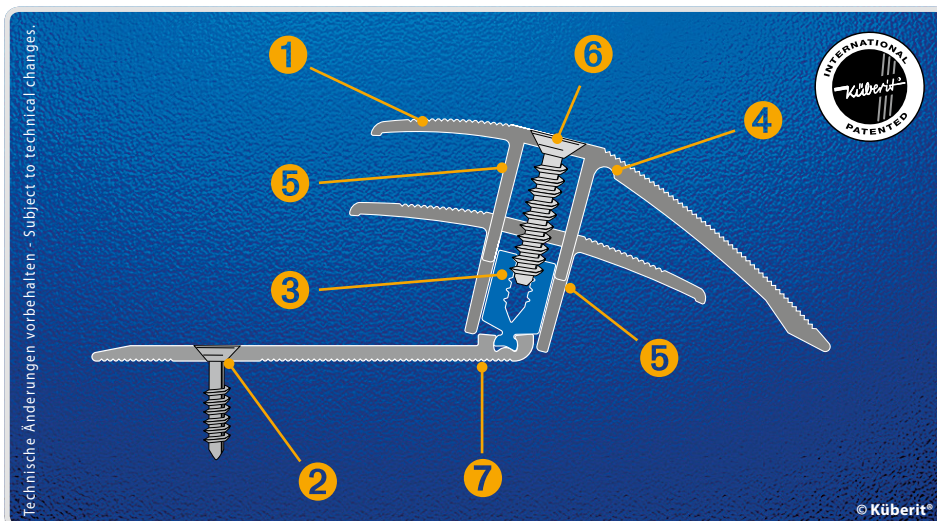

- 1 TOP-Profil
- 2 BASIS-Profil
Befestigung mit TORX-Schraube
(Verdübelung neben der Estrichfuge)
- 3 flex-Gelenk mit Schraubkanal
- 4 Sollbiegestelle
- 5 Führungsstege
- 6 TORX-Schraube
- 7 Kleberrillen (Verklebung bei Fußbodenheizung)

- 1 TOP profile
- 2 BASE profile
fastening with TORX screws
(anchor beside the subfloor joint)
- 3 flex joint with screw channel
- 4 predetermined bending point
- 5 spring edges
- 6 TORX screws
- 7 fluted for glueing (glue in case of floor heating)

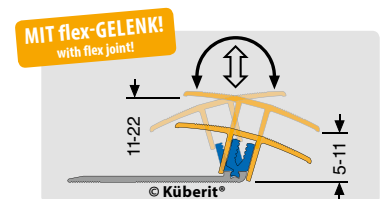
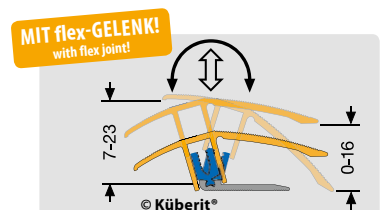

■ PPS®-Champion flex

Artikel
article

886

für Bodenbeläge von
for floor coverings from
⌀ 7–23 mm ◀ 14 mm

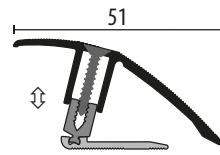

Farbe
colour

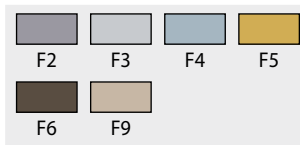

Länge
length

0,9 m
1,0 m
2,7 m
3,0 m

Version
version

SB	V
•	•
•	•
•	•
•	•



287 N

für Bodenbeläge von
for floor coverings from
⌀ 6,5–16 mm ◀ 19 mm

optional bis zu ⌀18 mm
optimal up to ⌀18 mm

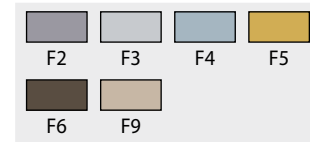
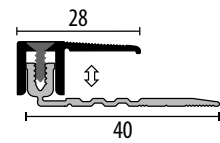

0,9 m
1,0 m
2,7 m
3,0 m

SB	V
•	•
•	•
•	•
•	•



888

für Bodenbeläge von
for floor coverings from
⌀ 7–17 mm ◀ 2x 14 mm

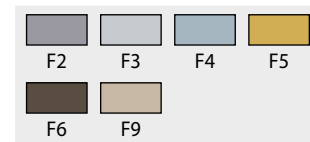
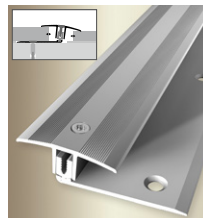
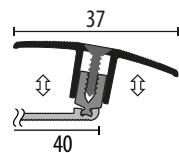

0,9 m
1,0 m
2,7 m
3,0 m

SB	V
•	•
•	•
•	•
•	•



Preise finden Sie ab Seite / Prices are indicated on page 202

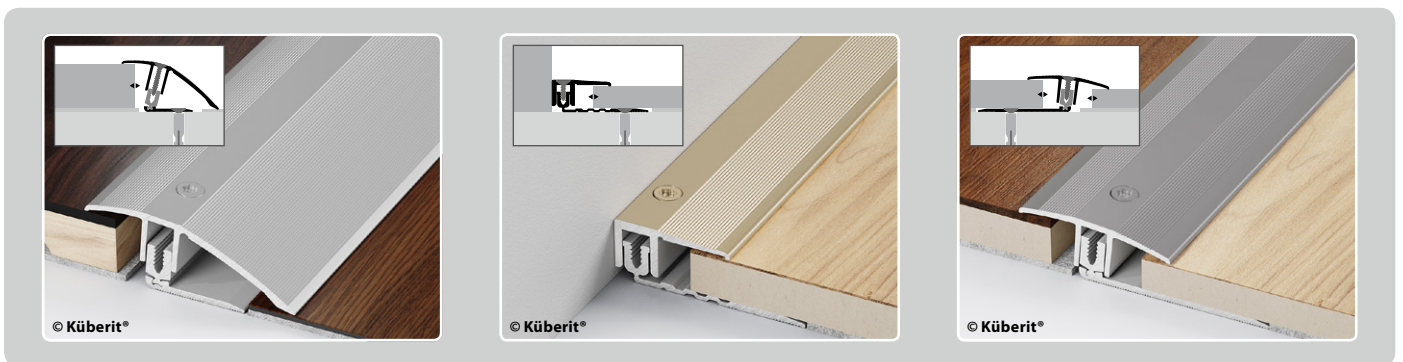

Zubehör / Accessories

PPS®-Lifter ⌀ 17–27 mm
aus glasfaserverstärktem Kunststoff (GFK),
zur Basisprofilerhöhung
made of glass-fiber reinforced plastic (GFRP),
for lifting the BASE profile

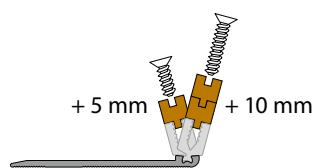

für / for
PPS®-Champion flex
PPS®-Champion / SK
PPS®-Champion smart
PPS®-Champion Star
PPS®-Allrounder
PPS®-AS
PPS®-Magic

Preise finden Sie auf Seite / Prices are indicated on page 203

■ PPS®-Champion flex Verlegeanleitung / Installation Instruction

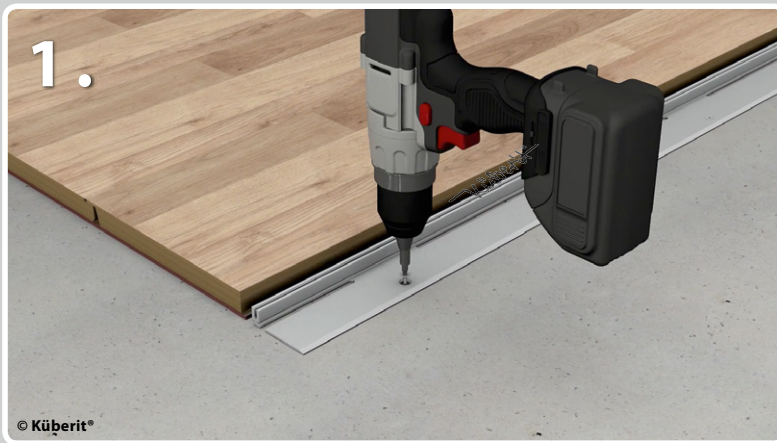

BASIS-Profil verschrauben oder verdübeln (= Durchsteckmontage) bzw. bei Fußbodenheizung einen 2-Komponenten-Kleber verwenden.

Screw or anchor **BASE profile** (= plug mounting). In case of floor heating, fasten the profile by using a two component adhesive.



Hartbodenbelag anpassen, dabei die vom Hersteller empfohlene **Dehnfuge** berücksichtigen!

Lay the hard floor covering and pay attention to the **expansion joint** as recommended by the flooring manufacturer!



Nur bei unter 8,5 mm starken Bodenbelägen auf die passgenaue Ausrichtung der längeren Schenkel vom **TOP-Profil** zur Verschiebenut des **BASIS-Profils** achten und **TOP-Profil** festschrauben.

For floor coverings of less than 8.5 mm thickness, make sure, that the long side of the **TOP profile** is aligned with the sliding groove of the **BASE profile** and screw the **TOP profile**.



Fertig ist die hochwertige Verlegung!

The high-quality installation is ready!

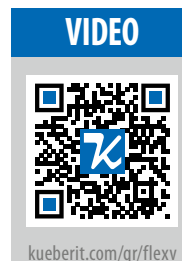
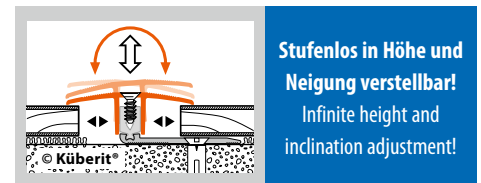

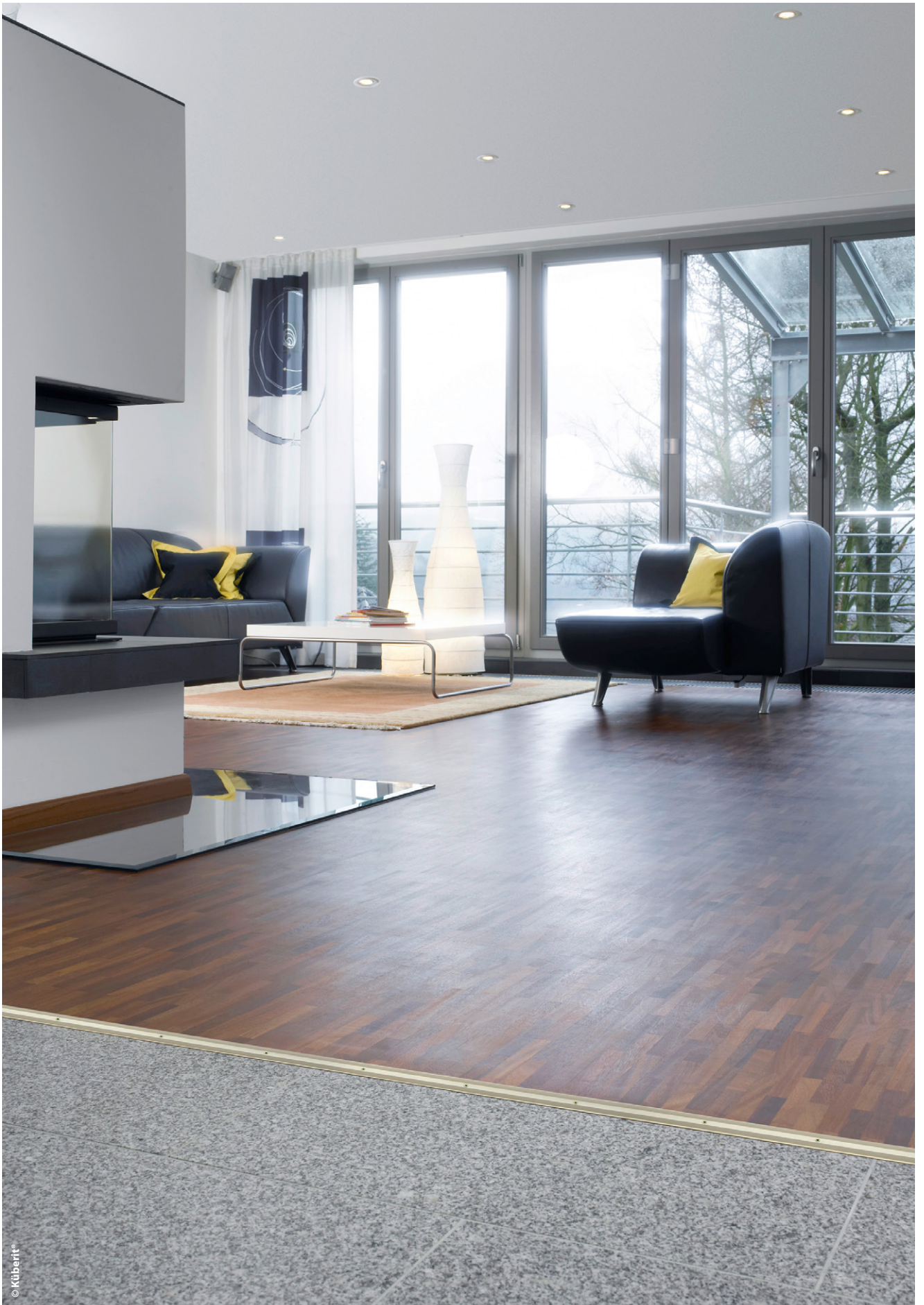

© Küberit®



TORX!

PPS®-Champion / smart / SK

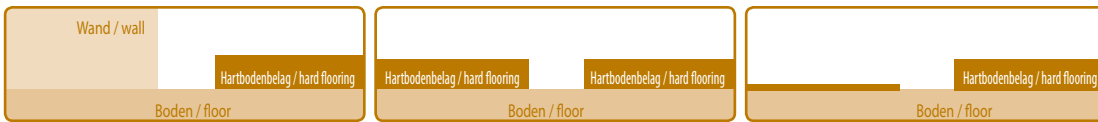

PPS[®]-Champion / smart / SK



PPS[®]-Champion

smart

PPS[®]-Champion

SK

PPS[®]-Champion



Das Küberit[®] PPS[®]-Champion System wurde für die Verlegung von unterschiedlich starken Parkett-, Laminat-, Furnier- und Korkböden mit einer Bodenbelagsstärke von 6,5 bis 16 mm entwickelt (optional erweiterbar bis 18 mm). Das technisch innovative Profilsystem steht in dezenter optischer Ausführung als Abschluss-, Übergangs- und Anpassungsprofil zur Verfügung.

Ergänzt wurde das innovative System um eine glatte Ausführung - PPS[®]-Champion smart - und eine selbstklebende Ausführung - PPS[®]-Champion SK - bei der das BASIS-Profil verklebt wird. Diese ist optimal geeignet für Fußbodenheizungen und man spart zudem Zeit bei der Montage, da das Verdübeln und Verschrauben des BASIS-Profils entfällt!

The Küberit[®] PPS[®]-Champion system was developed for parquet, laminate, veneer and cork floors with thicknesses of 6.5-16 mm (optional up to 18 mm). This technically innovative profile system with its discreet design is available as a border, connecting or adapting profile.

The innovative system was supplemented by a smooth version - PPS[®]-Champion smart - and a self-adhesive version - PPS[®]-Champion SK - in which the BASIS profile is bonded. Due to the adhesive on the wider BASE profile, this laying alternative is optimal for floor heatings. Further, this installation is time-saving as the BASE profile is not screwed to the floor.

■ PPS®-Champion / smart / SK

Die einzigartige Verlegelösung für Parkett, Laminat, Kork und mehrschichtige modulare Fußbodenbeläge

- PPS®-Champion, smart und selbstklebend mit neuem BASIS-Profil PPS® 4.0
- BASIS-Profil mit drei Verstellnuten und Sollbiegestelle zum Kippen
- das 40 mm breite BASIS-Profil ermöglicht eine seitlich versetzte Bohrung von der Estrichfuge oder eine größere Klebeauftragsfläche
- beim Übergangprofil können automatisch bis zu 5 mm unterschiedlich hohe Hartbodenbeläge verlegt werden
- durch einfache mechanische Anpassungen ist ein Höhenausgleich von bis zu 8 mm möglich
- Anwendungsbereich von 6,5 – 16 mm, optional bis 18 mm

erhältlich als:

ANPASSUNGSPROFIL (oder AUSGLEICHSPROFIL)
für alle Hartbodenbeläge an angrenzende, niedrigere Flächen oder Beläge

ABSCHLUSSPROFIL
für saubere Abschlüsse und Begrenzungen von Hartbodenbelägen vor höheren, angrenzenden Schwellen, Kacheln, Fliesen, Terrassentüren und -fenstern oder anderen Erhöhungen

ÜBERGANGSPROFIL (oder DEHNFUGENPROFIL)
für gleich hohe oder bis zu ± 3 mm unterschiedlich hohe Hartbodenbeläge

The unique installation solution for parquet, laminate, cork and multilayer modular flooring

- PPS®-Champion, smart and self-adhesive vision with new BASE profile PPS® 4.0
- BASE profile with three flex grooves and predetermined bending point to tilt
- the 40 mm wide BASE profile allows a laterally offset drilling to the screed joint or a wider adhesive surface
- with the connecting profile, wood floor coverings with a difference in height up to 5 mm can be installed
- through simple mechanical adjustments a height compensation of up to 8 mm is possible
- expanded application area of 6.5 – 16 mm, optional up to 18 mm

available as:

ADAPTING PROFILE
(or LEVELING PROFILE / REDUCER PROFILE)
for all hard floor coverings bordering lower areas or floors

BORDER PROFILE
for neat borders of hard floor coverings in front of higher sills, tiles, terrace doors and windows or other raisings

CONNECTING PROFILE (or EXPANSION JOINT PROFILE)
for hard floor coverings of equal level or up to ± 3 mm difference in height

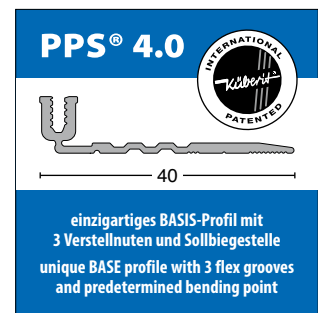

■ PPS®-Champion

Artikel
article

Farbe
colour

Länge
length

Version
version

286

für Bodenbeläge von
for floor coverings from
⌀ 6,5 – 16 mm ◀ 12 mm

optional bis zu ⌀ 18 mm
optinal up to ⌀ 18 mm

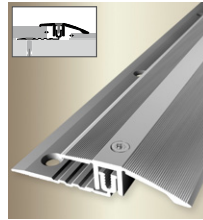
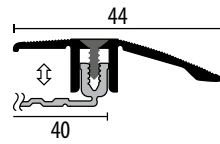

				0,9 m	SB	V
				1,0 m	•	•
				2,7 m	•	•
				3,0 m	•	•

	2,9					
--	-----	--	--	--	--	--

287

für Bodenbeläge von
for floor coverings from
⌀ 6,5 – 16 mm ◀ 12 mm

optional bis zu ⌀ 18 mm
optinal up to ⌀ 18 mm

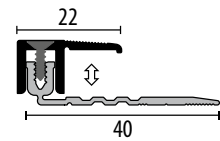

				0,9 m	SB	V
				1,0 m	•	•
				2,7 m	•	•
				3,0 m	•	•

	2,9					
--	-----	--	--	--	--	--

288

für Bodenbeläge von
for floor coverings from
⌀ 6,5 – 16 mm ◀ 2x 12 mm

optional bis zu ⌀ 18 mm
optinal up to ⌀ 18 mm

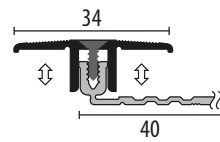

				0,9 m	SB	V
				1,0 m	•	•
				2,7 m	•	•
				3,0 m	•	•

	2,9					
--	-----	--	--	--	--	--

Preise finden Sie ab Seite / Prices are indicated on page 203

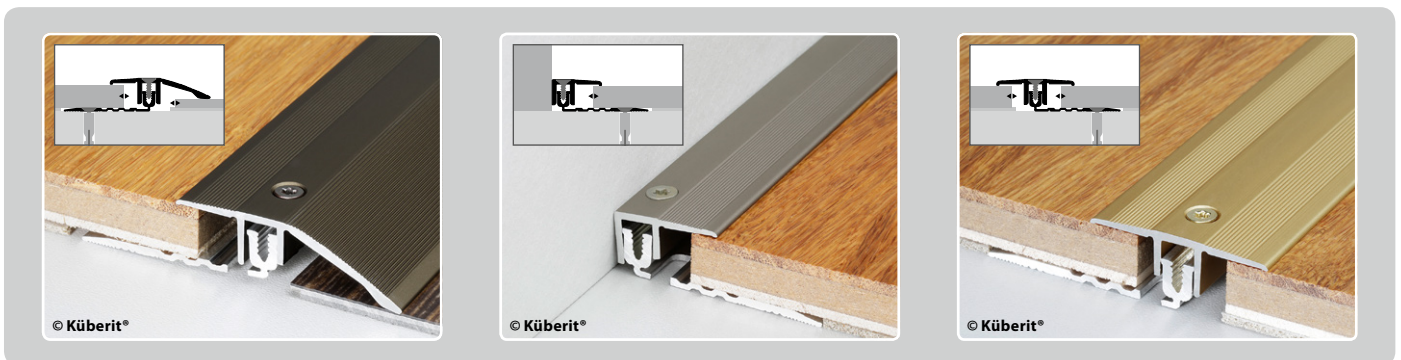

Zubehör / Accessories

PPS®-Lifter ⌀ 16–26 mm
aus glasfaserverstärktem Kunststoff (GFK),
zur Basisprofilerrhöhung
made of glass-fiber reinforced plastic (GFRP),
for lifting the BASE profile

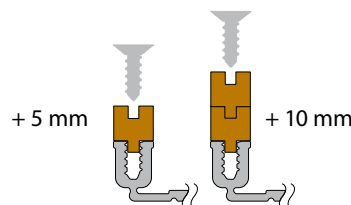

für / for
PPS®-Champion flex
PPS®-Champion / SK
PPS®-Champion smart
PPS®-Champion Star
PPS®-Allrounder
PPS®-AS
PPS®-Magic

Preise finden Sie auf Seite / Prices are indicated on page 203

Zubehör / Accessories

vorgefertigte PPS®-Kreuze und PPS®-Ecken / with prefabricated PPS® Crosses and PPS® Corners

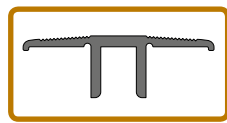
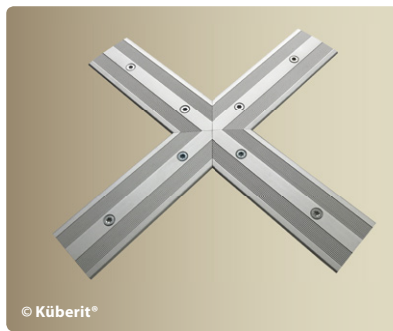

360°-Kreuz für Übergänge
360°-Cross for Connectings

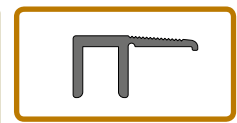
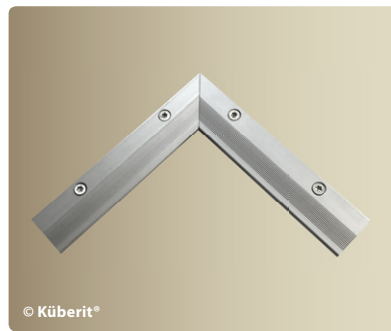

90°-Innenecke für Abschlüsse
90°-internal corner for Borders

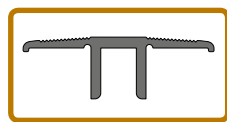
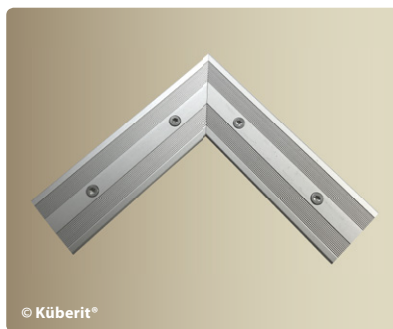

90°-Ecke für Übergänge
90°-Corner for Connecting

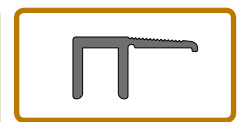

90°-Außenecke für Abschlüsse
90°-external corner for Borders

für / for
PPS®-Champion , PPS®-Allrounder, PPS®-Champion XXL, und PPS®-AS

Preise finden Sie ab Seite / Prices are indicated on page 203

■ PPS®-Champion smart · mit glatter Oberfläche / with plain surface

Artikel
article

Farbe
colour

Länge
length

Version
version

256
für Bodenbeläge von
for floor coverings from
⌀ 6,5 – 16 mm ◀ 12 mm
optional bis zu ⌀ 18 mm
optimal up to ⌀ 18 mm

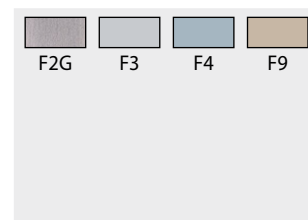
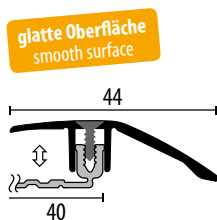

1,0 m	SB	V		
2,7 m	•	•		
3,0 m	•	•		
	2,9			

257
für Bodenbeläge von
for floor coverings from
⌀ 6,5 – 16 mm ◀ 12 mm
optional bis zu ⌀ 18 mm
optimal up to ⌀ 18 mm

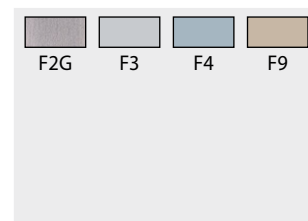
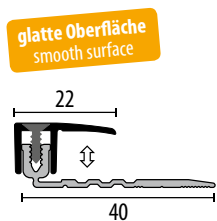

1,0 m	SB	V		
2,7 m	•	•		
3,0 m	•	•		
	2,9			

258
für Bodenbeläge von
for floor coverings from
⌀ 6,5 – 16 mm ◀ 2x 12 mm
optional bis zu ⌀ 18 mm
optimal up to ⌀ 18 mm

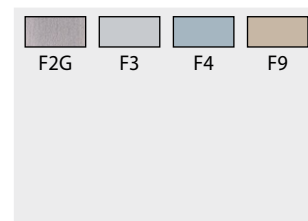
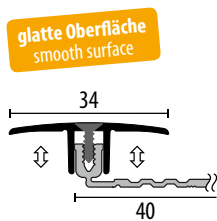

1,0 m	SB	V		
2,7 m	•	•		
3,0 m	•	•		
	2,9			

Preise finden Sie ab Seite / Prices are indicated on page 203

■ PPS®-Champion SK · die selbstklebende Ausführung / the self-adhesive version

Artikel
article

Farbe
colour

Länge
length

Version
version

286 SK

für Bodenbeläge von
for floor coverings from
↕ 6,5 – 16 mm ↔ 12 mm

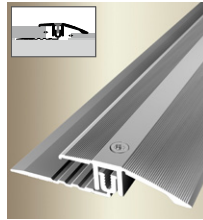
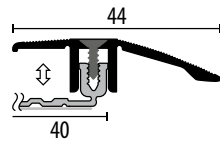

0,9 m
1,0 m
2,7 m
3,0 m



SB	SK
•	•
•	•
•	•
•	•

287 N/SK

für Bodenbeläge von
for floor coverings from
↕ 6,5 – 16 mm ↔ 12 mm

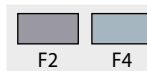
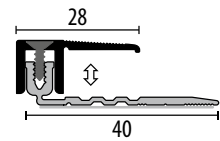

0,9 m
1,0 m
2,7 m
3,0 m



SB	SK
•	•
•	•
•	•
•	•

288 SK

für Bodenbeläge von
for floor coverings from
↕ 6,5 – 16 mm ↔ 2x 12 mm

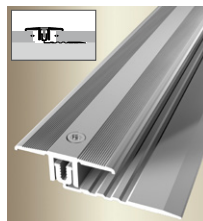
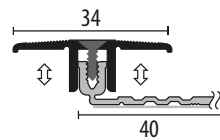

0,9 m
1,0 m
2,7 m
3,0 m



SB	SK
•	•
•	•
•	•
•	•

Preise finden Sie ab Seite / Prices are indicated on page 203



© Küberit®



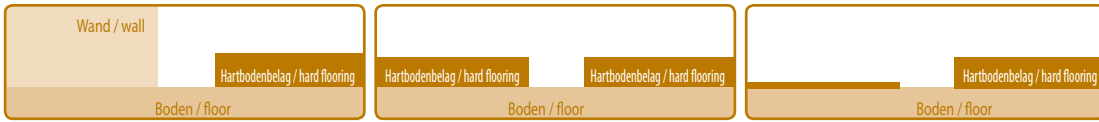

PPS[®]-Champion XXL / XXL S



PPS[®]-Champion **XXL**

PPS[®]-Champion **XXL S**

Das Profilsystem **PPS[®]-Champion XXL** wird schwerpunktmäßig bei der Verlegung von Parkett oder Massivholzdielen eingesetzt, um für den natürlichen Werkstoff Holz ausreichend Dehnfugen zu gewährleisten. Das System ist ausgelegt für Bodenbelagshöhen von 7–18 mm und zeichnet sich durch drei wesentliche Produktvorteile aus: Durch eine um +13 % größere Dehnfuge von jetzt 17,5 mm, der Verwendung von Torx-Schrauben sowie einer Verstärkung im gesenkten Bohrloch, die für einen sicheren Schraubensitz sorgt und während der Verschraubung des Profils einer eventuellen Schrägstellung der Schraube effektiv entgegenwirkt.

The profile system **PPS-Champion XXL** was mainly developed for the application of parquet and timber floor boards, to allow an effectual expansion joint for the natural material wood. The system was laid-out for floor covering heights of 7–18 mm and benefits from three advantages: The expansion joint was increased by 13 % to 17.5 mm. The utilisation of Torx screws and the reinforcement of the countersunk drill holes ensure a safe fit of the screws and counteracts the eventual inclination of the screws while bolting the profile.

■ PPS®-Champion XXL / PPS®-Champion XXL S

Die optimale, fachmännische und bewährte Verlegetechnik für Parkett, Starkparkett und Massivholzdielen

- für Parkett und Massivholzdielen von 7 – 18 mm
- bei der speziellen XXL S Version Höhen von 18 – 29 mm
- größere Dehnungsfuge von jetzt 17 bzw. 20 mm
- mit Torx-Schrauben

erhältlich als:

ANPASSUNGSPROFIL (oder AUSGLEICHSPROFIL)
für alle Hartbodenbeläge an angrenzende, niedrigere Flächen oder Beläge

ABSCHLUSSPROFIL
für saubere Abschlüsse und Begrenzungen von Hartbodenbelägen vor höheren, angrenzenden Schwellen, Kacheln, Fliesen, Terrassentüren und -fenstern oder anderen Erhöhungen

ÜBERGANGSPROFIL (oder DEHNFUGENPROFIL)
für gleich hohe oder bis zu ± 3 mm unterschiedlich hohe Hartbodenbeläge

Ideal and professional installation solution for parquet, solid parquet and timber floor boards

- for natural wood, parquet and timber floor boards from 7 – 18 mm
- for the special XXL S version heights from 18 – 29 mm
- larger expansion joint of now 17 or 20 mm
- with Torx screws

available as:

ADAPTING PROFILE (or LEVELING PROFILE / REDUCER PROFILE)
for all hard floor coverings bordering lower areas or floors

BORDER PROFILE
for neat borders of hard floor coverings in front of higher sills, tiles, terrace doors and windows or other raisings

CONNECTING PROFILE (or EXPANSION JOINT PROFILE)
for hard floor coverings of equal level or up to ± 3 mm difference in height

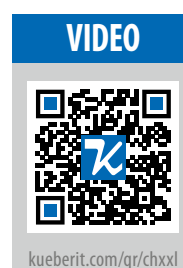
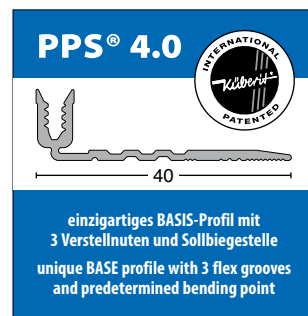

■ PPS®-Champion XXL

Artikel
article

386 XXL

für Bodenbeläge von
for floor coverings from
↕ 7 – 18 mm ↔ 17 mm

optional bis zu ↕ 20 mm
optimal up to ↕ 20 mm

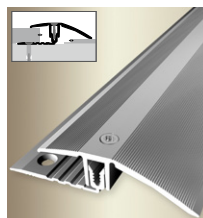
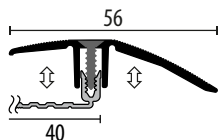

Farbe
colour

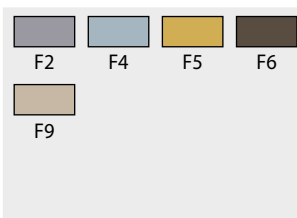

Länge
length

0,9 m
1,0 m
2,7 m
3,0 m

Version
version

SB	V
•	•
•	•
•	•
•	•

387 XXL

für Bodenbeläge von
for floor coverings from
↕ 7 – 18 mm ↔ 20 mm

optional bis zu ↕ 20 mm
optimal up to ↕ 20 mm

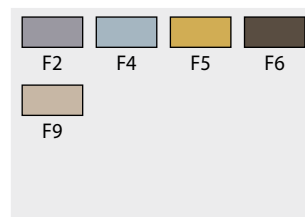
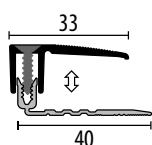

0,9 m
1,0 m
2,7 m
3,0 m

SB	V
•	•
•	•
•	•
•	•

388 XXL

für Bodenbeläge von
for floor coverings from
↕ 7 – 18 mm ↔ 2x 17 mm

optional bis zu ↕ 20 mm
optimal up to ↕ 20 mm

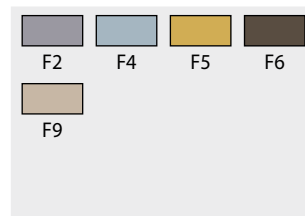
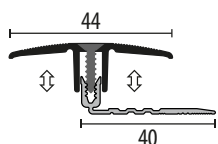

0,9 m
1,0 m
2,7 m
3,0 m

SB	V
•	•
•	•
•	•
•	•

Preise finden Sie ab Seite / Prices are indicated on page 204

Zubehör / Accessories

PPS®-Lifter XXL ↕ 18–32 mm XXL / ↕ 29–43 mm XXL S
aus glasfaserverstärktem Kunststoff (GFK),
zur Basisprofilerhöhung
made of glass-fiber reinforced plastic (GFRP),
for lifting the BASE profile

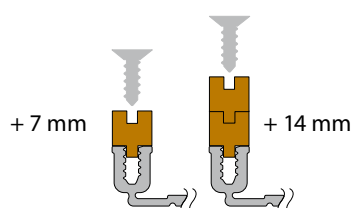

für / for
PPS®-Champion XXL
PPS®-Champion XXL S

Preise finden Sie auf Seite / Prices are indicated on page 203

Zubehör / Accessories

vorgefertigte PPS®-Kreuze und PPS®-Ecken / with prefabricated PPS® Crosses and PPS® Corners

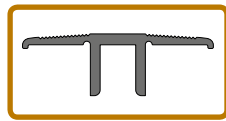
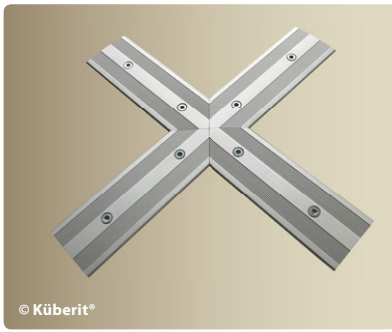

360°-Kreuz für Übergänge
360°-Cross for Connectings

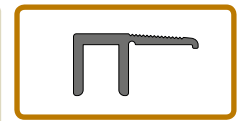
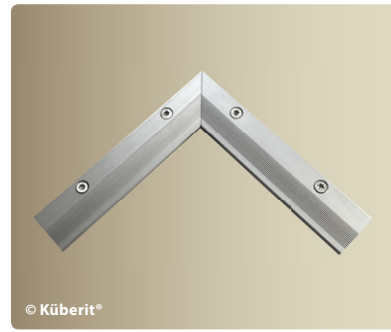

90°-Innenecke für Abschlüsse
90°-internal corner for Borders

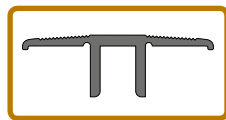
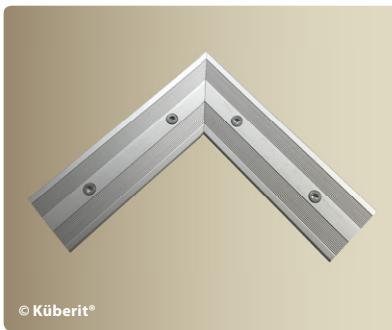

90°-Ecke für Übergänge
90°-Corner for Connecting

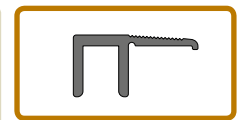

90°-Außenecke für Abschlüsse
90°-external corner for Borders

für / for
PPS®-Champion, PPS®-Allrounder, PPS®-Champion XXL, und PPS®-AS

Preise finden Sie ab Seite / Prices are indicated on page 204

■ PPS®-Champion XXL S

Artikel
article

Farbe
colour

Länge
length

Version
version

386 XXL S*

für Starkparkett von
for solid parquet from
⇄ 18–29 mm ⇄ 17 mm

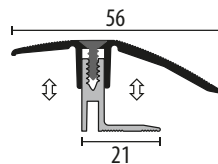

F2	F4	F9

0,9 m	SB	V		
2,7 m	•	•		
	•	•		
	3,5			

387 XXL S*

für Starkparkett von
for solid parquet from
⇄ 18–29 mm ⇄ 20 mm

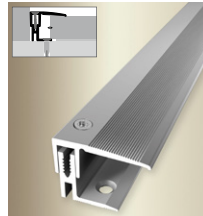
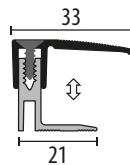

F2	F4	F9

0,9 m	SB	V		
2,7 m	•	•		
	•	•		
	3,5			

388 XXL S*

für Starkparkett von
for solid parquet from
⇄ 18–29 mm ⇄ 2x 17 mm

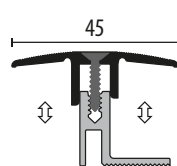

F2	F4	F9

0,9 m	SB	V		
2,7 m	•	•		
	•	•		
	3,5			

* Auslaufartikel - Discontinued line

Preise finden Sie ab Seite / Prices are indicated on page 204



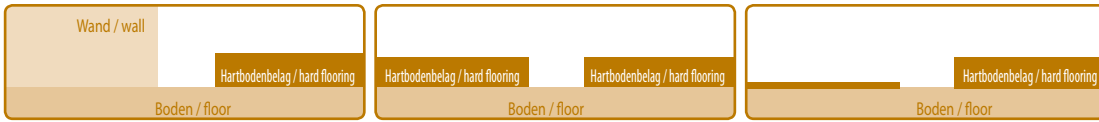

PPS®-Allrounder



PPS®-Allrounder

Dieses technisch innovative Küberit-Schraubsystem ist für den Fachmann die optimale Lösung, wenn es um die Verlegung von unterschiedlich starken Parkett-, Laminat- und Korkböden sowie mehrschichtigen modularen Fußbodenbelägen geht. Das *Küberit*® **PPS®-Allrounder** ist für Bodenbelagsstärken von 7 bis 15 mm, optional sogar bis 17 mm entwickelt worden. In dezent optischer Ausführung wird es als Abschluss-, Übergangs- und Anpassungsprofil in 5 Aluminium-Farbtönen angeboten.

This technically innovative Küberit fastening system is the optimal solution for the professional installer when it comes to the installation of parquet, laminate and cork floors of different heights and multi-layer modular floorings. The *Küberit*® **PPS®-Allrounder** has been developed for flooring heights from 7 to 15 mm, optionally even up to 17 mm. In a subtle design, it is offered as an border, connecting, and adapting profile in 5 aluminium colours.

■ PPS®-Allrounder

Die einzigartige Verlegelösung für Parkett, Laminat, Kork und mehrschichtige modulare Fußbodenbeläge

- mit neuem BASIS-Profil PPS® 4.0
- BASIS-Profil mit drei Verstellnuten und Sollbiegestelle zum Kippen
- das 40 mm breite BASIS-Profil ermöglicht eine seitlich versetzte Bohrung von der Estrichfuge oder eine größere Klebeauftragsfläche
- beim Übergangprofil können automatisch bis zu 5 mm unterschiedlich hohe Hartbodenbeläge verlegt werden
- durch einfache mechanische Anpassungen ist ein Höhenausgleich von bis zu 8 mm möglich
- Anwendungsbereich von 7 – 15 mm, optional bis 17 mm

erhältlich als:

ANPASSUNGSPROFIL (oder AUSGLEICHSPROFIL)
für alle Hartbodenbeläge an angrenzende, niedrigere Flächen oder Beläge

ABSCHLUSSPROFIL
für saubere Abschlüsse und Begrenzungen von Hartbodenbelägen vor höheren, angrenzenden Schwellen, Kacheln, Fliesen, Terrassentüren und -fenstern oder anderen Erhöhungen

ÜBERGANGSPROFIL (oder DEHNFUGENPROFIL)
für gleich hohe oder bis zu ± 3 mm unterschiedlich hohe Hartbodenbeläge

The unique installation solution for parquet, laminate, cork and multilayer modular flooring

- with new BASE profile PPS® 4.0
- BASE profile with three flex grooves and predetermined bending point to tilt
- the 40 mm wide BASE profile allows a laterally offset drilling to the screed joint or a wider adhesive surface
- with the connecting profile, wood floor coverings with a difference in height up to 5 mm can be installed
- through simple mechanical adjustments a height compensation of up to 8 mm is possible
- expanded application area of 7 – 15 mm, optional up to 17 mm

available as:

ADAPTING PROFILE (or LEVELING PROFILE / REDUCER PROFILE)
for all hard floor coverings bordering lower areas or floors

BORDER PROFILE
for neat borders of hard floor coverings in front of higher sills, tiles, terrace doors and windows or other raisings

CONNECTING PROFILE (or EXPANSION JOINT PROFILE)
for hard floor coverings of equal level or up to ± 3 mm difference in height

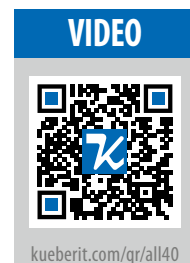
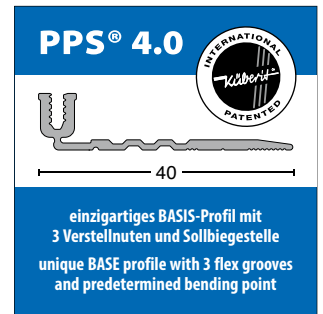

Zubehör / Accessories

vorgefertigte PPS®-Kreuze und PPS®-Ecken / with prefabricated PPS® Crosses and PPS® Corners

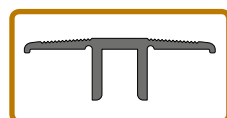
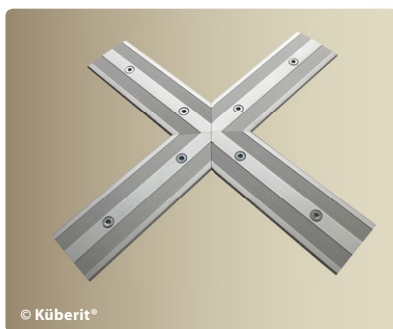

360°-Kreuz für Übergänge
360°-Cross for Connectings

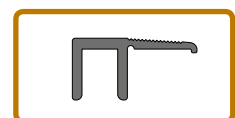
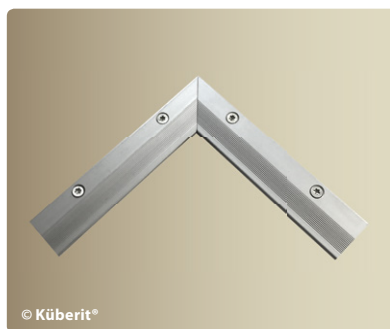

90°-Innenecke für Abschlüsse
90°-internal corner for Borders

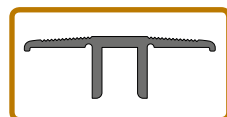
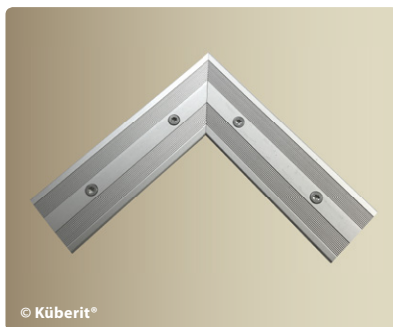

90°-Ecke für Übergänge
90°-Corner for Connecting

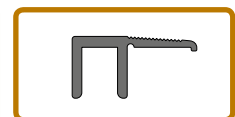

90°-Außenecke für Abschlüsse
90°-external corner for Borders

für / for
PPS®-Champion, PPS®-Allrounder, PPS®-Champion XXL, und PPS®-AS

Preise finden Sie ab Seite / Prices are indicated on page 205

■ PPS®-Allrounder

Artikel
article

Farbe
colour

Länge
length

Version
version

486

für Bodenbeläge von
for floor coverings from
⌀ 7–15 mm ◀ 12 mm

optional bis zu ⌀17 mm
optinal up to ⌀17 mm

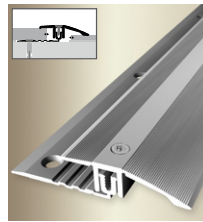
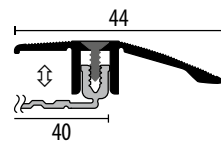

				0,9 m 1,0 m 2,7 m 3,0 m	SB • • • •	V • • • •		

487

für Bodenbeläge von
for floor coverings from
⌀ 7–15 mm ◀ 12 mm

optional bis zu ⌀17 mm
optinal up to ⌀17 mm

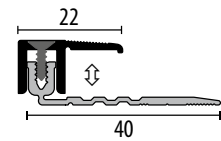

				0,9 m 1,0 m 2,7 m 3,0 m	SB • • • •	V • • • •		

488

für Bodenbeläge von
for floor coverings from
⌀ 7–15 mm ◀ 2x 12 mm

optional bis zu ⌀17 mm
optinal up to ⌀17 mm

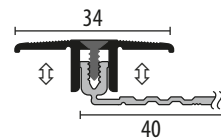

				0,9 m 1,0 m 2,7 m 3,0 m	SB • • • •	V • • • •		

Preise finden Sie ab Seite / Prices are indicated on page 205

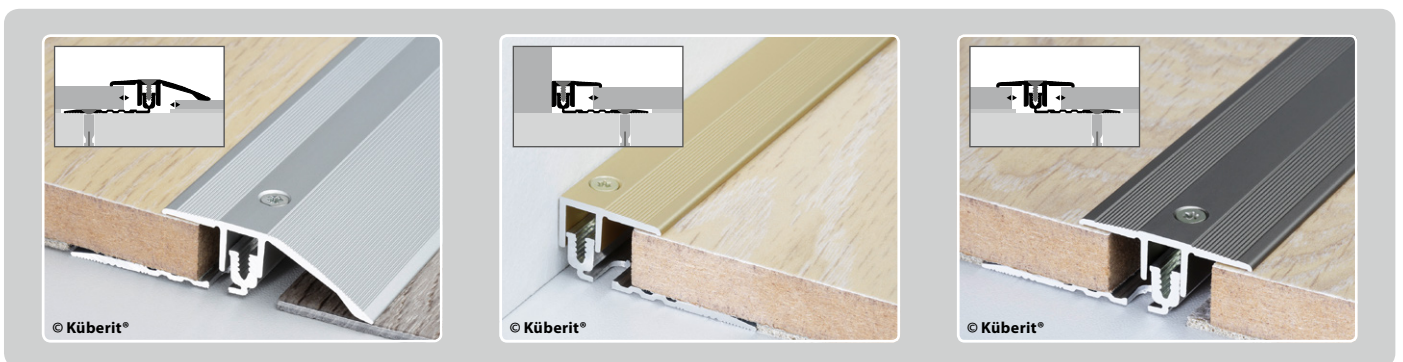

Zubehör / Accessories

PPS®-Lifter ⌀ 15–25 mm
aus glasfaserverstärktem Kunststoff (GFK),
zur Basisprofilerrhöhung
made of glass-fiber reinforced plastic (GFRP),
for lifting the BASE profile

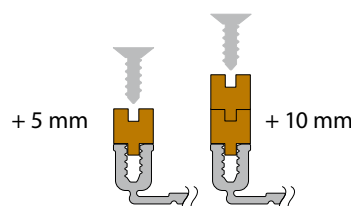

für / for
PPS®-Champion flex
PPS®-Champion / SK
PPS®-Champion smart
PPS®-Champion Star
PPS®-Allrounder
PPS®-AS
PPS®-Magic

Preise finden Sie auf Seite / Prices are indicated on page 203



TORX!

PPS®-AS

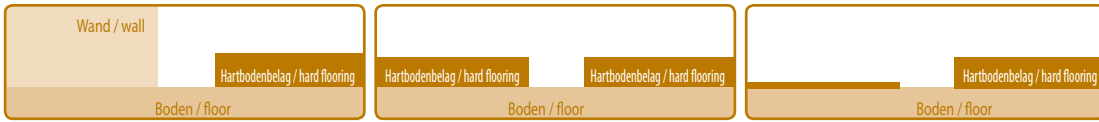

PPS®-AS



PPS®-AS

Speziell für Laminatböden sowie schwimmend verlegte Designböden ist **PPS®-AS** geeignet. Das zweiteilige Profilsystem ist einsetzbar bei Bodenbelagshöhen von 5 – 11,5 mm und verfügt über eine ausreichend große Dehnfuge. Der Einsatz von Torx-Schrauben – wie bei allen Küberit-Profilsystemen – sowie eine Verstärkung im Bohrloch sorgen für einen sicheren Schraubensitz und wirken während der Verschraubung einer eventuellen Schrägstellung nachhaltig entgegen.

The **PPS®-AS** was designed in particular for floating installed laminate and Click LVT floorings. The 2-part profiles system is suitable for floorings from 5 – 11.5 mm and has expansion gap increased to the forerunning profile system. The use of torx screws – like all Küberit profile systems – as well as a reinforcement of the drilling holes ensure a safe fit of the screws and avoid a potential inclination of the screws.

■ PPS®-AS

Das Schraub-Profilssystem für LVT-Designbeläge und Teppichböden

- für Designböden von 5 – 11,5 mm
- für Teppichböden bis zu 14 mm
- formschönes TOP-Profil mit geringer Aufbauhöhe
- Einsatz von hochwertigen TORX-Schrauben
- Verstärkung im gesenkten Bohrloch sorgt für eine optimale Befestigung
- das 40 mm breite BASIS-Profil ermöglicht eine seitlich versetzte Bohrung von der Estrichfuge oder eine größere Klebefläche

erhältlich als:

ANPASSUNGSPROFIL (oder AUSGLEICHSPROFIL)
für alle Hartbodenbeläge an angrenzende, niedrigere Flächen oder Beläge

ABSCHLUSSPROFIL
für saubere Abschlüsse und Begrenzungen von Hartbodenbelägen vor höheren, angrenzenden Schwellen, Kacheln, Fliesen, Terrassentüren und -fenstern oder anderen Erhöhungen

ÜBERGANGSPROFIL (oder DEHNFUGENPROFIL)
für gleich hohe oder bis zu ± 3 mm unterschiedlich hohe Hartbodenbeläge

The screw profile system for LVT floors and carpet floor coverings

- for LVT floors from 5 – 11.5 mm
- for carpet floors up to 14 mm
- appealingly designed TOP profile with a flat buildup
- use of high quality TORX-screws
- reinforced countersunk bore-holes ensure optimum installation
- the 40 mm wide BASE profile allows a laterally offset drilling to the screed joint or a wider adhesive surface

available as:

ADAPTING PROFILE
(or LEVELING PROFILE / REDUCER PROFILE)
for all hard floor coverings bordering lower areas or floors

BORDER PROFILE
for neat borders of hard floor coverings in front of higher sills, tiles, terrace doors and windows or other raisings

CONNECTING PROFILE (or EXPANSION JOINT PROFILE)
for hard floor coverings of equal level or up to ± 3 mm difference in height

Zubehör / Accessories

PPS®-Lifter \updownarrow 11,5–21,5 mm
aus glasfaserverstärktem Kunststoff (GFK), zur Basisprofilerhöhung
made of glass-fiber reinforced plastic (GFRP), for lifting the BASE profile

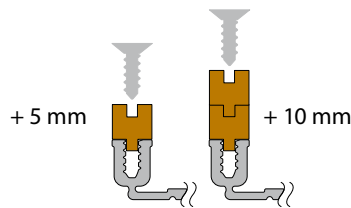

für / for
PPS®-Champion flex
PPS®-Champion / SK
PPS®-Champion smart
PPS®-Champion Star
PPS®-Allrounder
PPS®-AS
PPS®-Magic

Preise finden Sie auf Seite / Prices are indicated on page 203



■ PPS®-AS

Artikel
article

Farbe
colour

Länge
length

Version
version

386 AS

für Bodenbeläge von
for floor coverings from
⌀ 5 – 11,5 mm ◀ 12 mm

optional bis zu ⌀ 13,5 mm
optinal up to ⌀ 13,5 mm

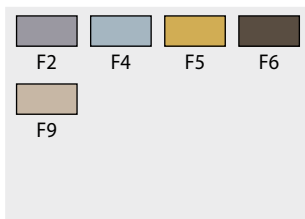
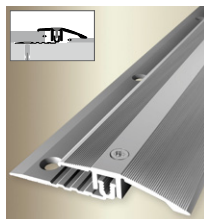
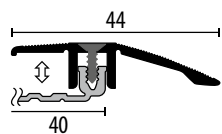

0,9 m	SB	V		
1,0 m	•	•		
2,7 m	•	•		
3,0 m	•	•		
	2,9			

387 AS

für Bodenbeläge von
for floor coverings from
⌀ 5 – 11,5 mm ◀ 12 mm

optional bis zu ⌀ 13,5 mm
optinal up to ⌀ 13,5 mm

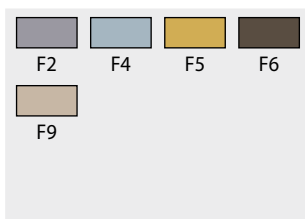
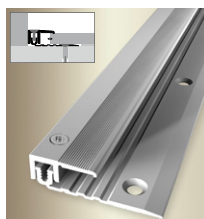
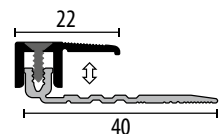



0,9 m	SB	V		
1,0 m	•	•		
2,7 m	•	•		
3,0 m	•	•		
	2,9			

388 AS

für Bodenbeläge von
for floor coverings from
⌀ 5 – 11,5 mm ◀ 2x 12 mm

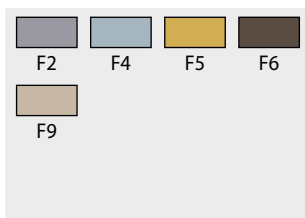
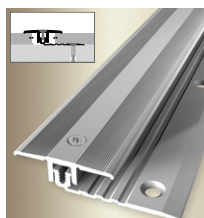
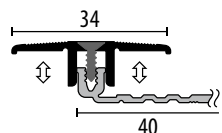
optional bis zu ⌀ 13,5 mm
optinal up to ⌀ 13,5 mm



0,9 m	SB	V		
1,0 m	•	•		
2,7 m	•	•		
3,0 m	•	•		
	2,9			

Preise finden Sie ab Seite / Prices are indicated on page 205

Zubehör / Accessories

vorgefertigte PPS®-Kreuze und PPS®-Ecken / with prefabricated PPS® Crosses and PPS® Corners

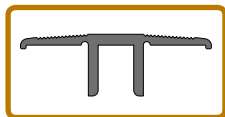
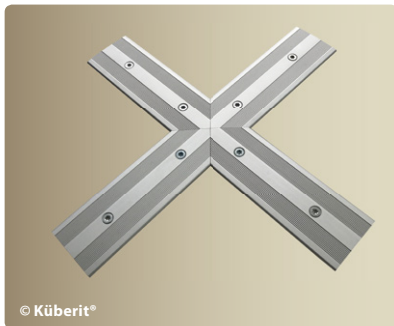

360°-Kreuz für Übergänge
360°-Cross for Connectings

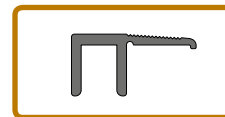
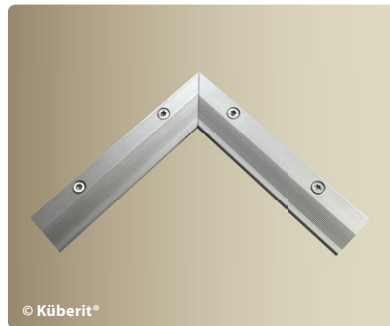

90°-Innenecke für Abschlüsse
90°-internal corner for Borders

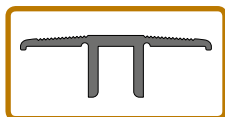
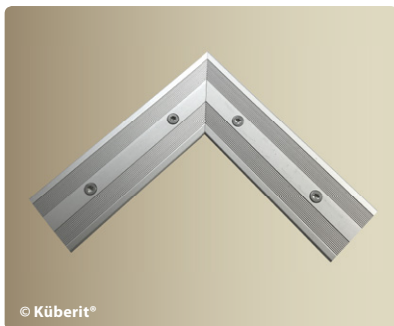

90°-Ecke für Übergänge
90°-Corner for Connecting

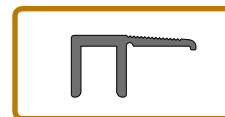

90°-Außenecke für Abschlüsse
90°-external corner for Borders

für / for
PPS®-Champion, PPS®-Allrounder, PPS®-Champion XXL, und PPS®-AS

Preise finden Sie ab Seite / Prices are indicated on page 205



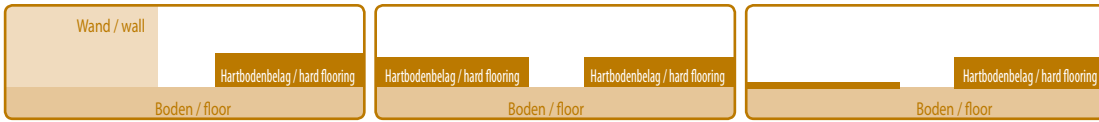

PPS[®]-Magic



PPS[®]-Magic

PPS[®]-Magic ist ein einzigartiges Klapp-Profilsystem mit Spannfeder für Parkett, Laminat und Kork. Die Besonderheit unseres Systems ist, dass die Verschraubung unsichtbar bleibt und die technischen Vorteile einer Schraubverbindung mit den optischen Vorteilen eines Clip-Profils vereint werden. Zudem kann das System als Kabelkanal verwendet werden, in dem mehrere kleine Kabel (z. B. für Telefon, Lautsprecher usw.) oder ein normales Kabel mit 3 Adern „versteckt“ werden können. Der bewusst flache Aufbau verhindert dabei optimal Stolperfallen.

PPS[®]-Magic ist anpassbar für alle Hartbodenbeläge von 7–16 mm und ist in Aluminium eloxiert silber und edelstahl optik sowie in den Längen 0,9 und 2,7 m lieferbar.

PPS[®]-Magic is a unique profile system for parquet, laminate and cork. It is available with a tension spring to open the TOP profile and hide the screws. A special feature is the combination of the technical advantages of a screw-down system with optical advantages of a clip profile. Furthermore the system may be used as cable channel e.g. for telephone or speaker cables. The flat construction avoids stumbling over it. **PPS[®]-Magic** is adaptable for all hard floor coverings from 7 – 16 mm and available in silver and stainless steel optic in lengths of 0.9 and 2.7 m.



■ PPS®-Magic

erhältlich als:

ANPASSUNGSPROFIL (oder AUSGLEICHSPROFIL)

für alle Hartbodenbeläge an angrenzende, niedrigere Flächen oder Beläge

ABSCHLUSSPROFIL

für saubere Abschlüsse und Begrenzungen von Hartbodenbelägen vor höheren, angrenzenden Schwellen, Kacheln, Fliesen, Terrassentüren und -fenstern oder anderen Erhöhungen

ÜBERGANGSPROFIL (oder DEHNFUGENPROFIL)

für gleich hohe oder bis zu ± 2 mm unterschiedlich hohe Hartbodenbeläge

available as:

ADAPTING PROFILE

(or LEVELING PROFILE / REDUCER PROFILE)

for all hard floor coverings bordering lower areas or floors

BORDER PROFILE

for neat borders of hard floor coverings in front of higher sills, tiles, terrace doors and windows or other raisings

CONNECTING PROFILE (or EXPANSION JOINT PROFILE)

for hard floor coverings of equal level or up to ± 2 mm difference in height

Artikel
article

552

für Bodenbeläge von
for floor coverings from

7–16 mm \leftrightarrow 12 mm

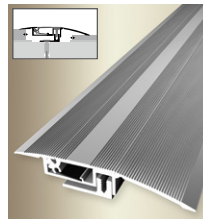
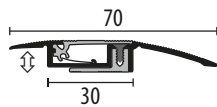

Farbe
colour



Länge
length

0,9 m
2,7 m



Version
version

SB
•
•

V
•
•

550

für Bodenbeläge von
for floor coverings from

7–16 mm \leftrightarrow 12 mm

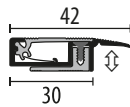

0,9 m
2,7 m



SB
•
•

V
•
•

551

für Bodenbeläge von
for floor coverings from

7–16 mm \leftrightarrow 2x 12 mm

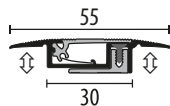

0,9 m
2,7 m



SB
•
•

V
•
•

Preise finden Sie ab Seite / Prices are indicated on page 206

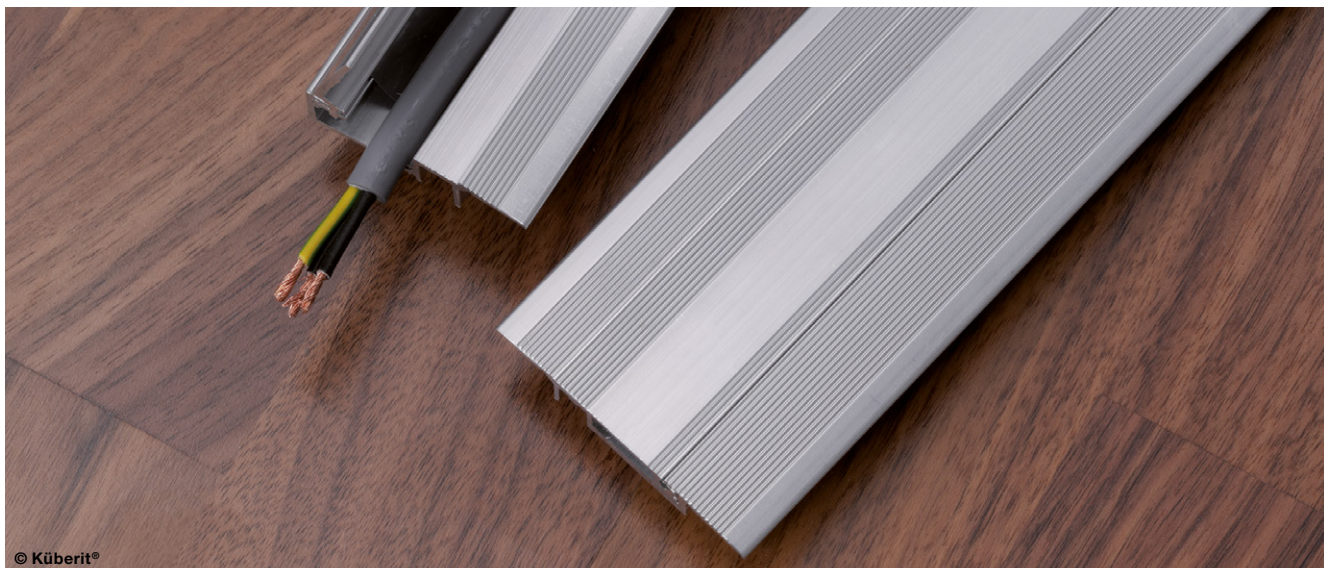



© Küberit®

Zubehör / Accessories

PPS®-Lifter ⌀ 16–26 mm
 aus glasfaserverstärktem Kunststoff (GFK),
 zur Basisprofilerrhöhung
 made of glass-fiber reinforced plastic (GFRP),
 for lifting the BASE profile

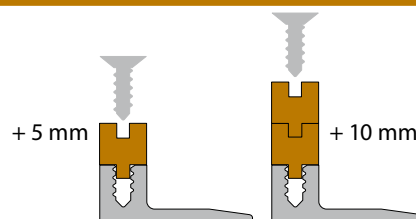

für / for
 PPS®-Champion flex
 PPS®-Champion / SK
 PPS®-Champion smart
 PPS®-Champion Star
 PPS®-Allrounder
 PPS®-AS
 PPS®-Magic

Preise finden Sie auf Seite / Prices are indicated on page 203



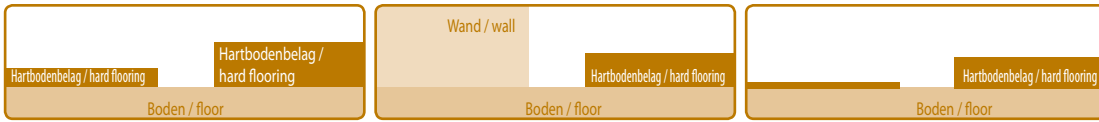

FCS®-718



FCS®-718



Unter der Produktbezeichnung **FCS®-718** hat Küberit das flexible Aluminium Clipsystem mit zwei Schwenkebenen im TOP-Profil entwickelt. Mit diesem innovativen System können Höhenunterschiede von bis zu 10 mm automatisch und stufenlos ausgeglichen werden. Dieses dreiteilige Profilsystem ist bei gleich hohen Übergängen von 7 bis 18 mm anpassbar und neben den gängigen Eloxalfarben auch mit Holzdekoren im Digitaldruck erhältlich.

By the product name **FCS®-718** Küberit developed the aluminium flexible Clip System with two swivel levels in the TOP profile which allows to automatically and infinitely level differences in height up to 10 mm. This three-part profile system is suitable for transitions of equal levels for all hard floor coverings from 7 up to 18 mm and available in aluminium anodized colours and digital printed and coated wood decors.

■ FCS®-718

Bewährte FCS®-718 Verlegelösung:

- weltweit technisch einzigartig
- Clipsystem mit 2 Schwenkebenen
- zeitsparender Einbau
- universell anpassbar für alle Hartbodenbeläge von 7 – 18 mm durch nur ein Profil
- geringere Lagerkosten
- elegante und hochwertige Oberflächen

Verbessertes FCS®-718 Profilsystem durch neue Kunststoffadapter:

- leichteres Einschieben durch geringere Maßtoleranzen
- zudem sichere Arretierung
- höhere Treffsicherheit beim Aufsetzen des TOP-Profils, insbesondere zwischen Türzargen
- angemessener Kraftaufwand
- sicheres Einrasten aufgrund der feineren Zahnung und höhere Haftkraft bei der Verbindung von TOP- zu BASIS-Profil
- lösen des TOP-Profils durch Einsatz eines Spachtels möglich
- mit dem Übergangprofil ist ein Ausgleich von Höhenunterschieden von bis zu 10 mm möglich

Proven FCS®-718 installation solution:

- worldwide technically unique
- Clip system with 2 swivel levels
- timesaving installation
- adjustable to all hard floor coverings from 7 – 18 mm with only one profile
- lower storage costs
- elegant and high-quality surfaces

Improved FCS®-718 profile system through new plastic adapters:

- easy insertion of the plastic adapter
- secure locking
- higher accuracy on the setting of the TOP profile, especially between doorframes
- little effort required
- secure snap in because of the finer toothing and higher holding force on the connection of the TOP and the BASE profile
- removal of the TOP profile with a spatula
- with the connecting profile the compensation of height differences of up to 10 mm is possible

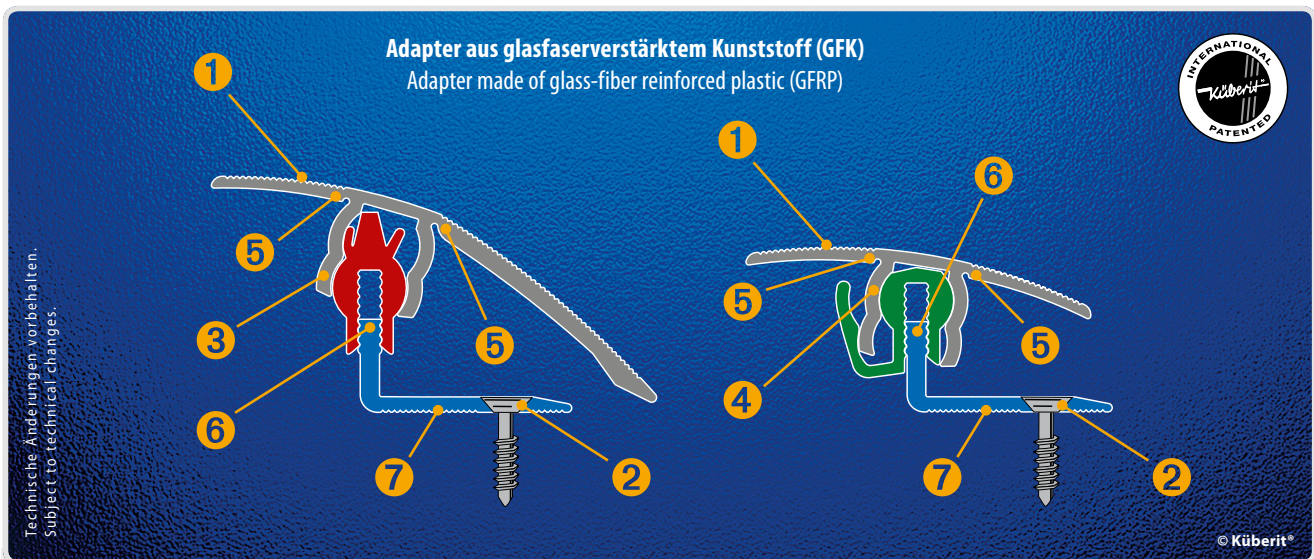

FCS®-718

- ❶ TOP-Profil
- ❷ BASIS-Profil
Befestigung mit TORX-Schraube
(Verdübelung neben der Estrichfuge)
- ❸ Schwenkebene 1
für rote oder graue Adapter bei Bodenbelägen über 13 mm
- ❹ Schwenkebene 2
für grüne oder graue Adapter bei Bodenbelägen unter 13 mm
- ❺ Sollbiegestelle
- ❻ Führungssteg mit Sicherheitsrastung
- ❼ Kleberrillen (Verklebung bei Fußbodenheizung)

FCS®-718

- ❶ TOP profile
- ❷ BASE profile
fastening with TORX screws
(anchor alongside the subfloor joint)
- ❸ swivel level 1
use red or grey adapter for floor coverings over 13 mm
- ❹ swivel level 2
use green or grey adapter for floor coverings under 13 mm
- ❺ predetermined bending point
- ❻ guide rail with safety raster
- ❼ fluted for glueing (glue in case of underfloor heating)

■ FCS®-718

Artikel
article

786

für Bodenbeläge von
for floor coverings from
⇄ 3–23 mm ⇄ 13 mm

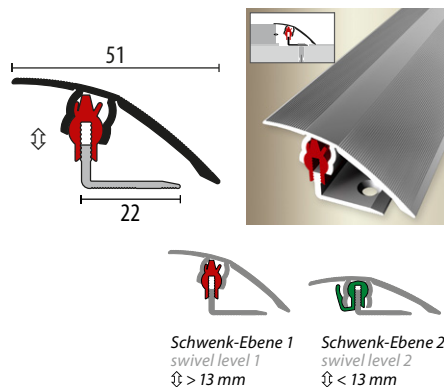

Farbe
colour

Länge
length

Version
version

				0,9 m 2,7 m	SB	U	H
					•	•	•

DIGITAL
PRINT DECOR COATING
by Küberit

787

für Bodenbeläge von
for floor coverings from
⇄ 7–18 mm ⇄ 16 mm

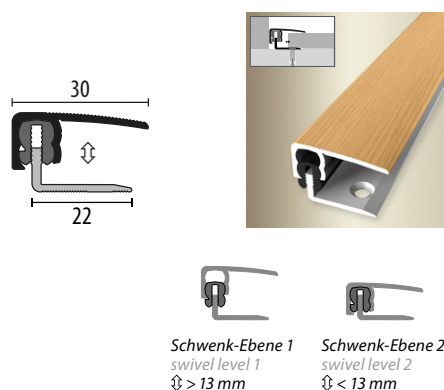

				0,9 m 2,7 m	SB	U	H
					•	•	•

DIGITAL
PRINT DECOR COATING
by Küberit

788

für Bodenbeläge von
for floor coverings from
⇄ 7–18 mm ⇄ 2x 13 mm

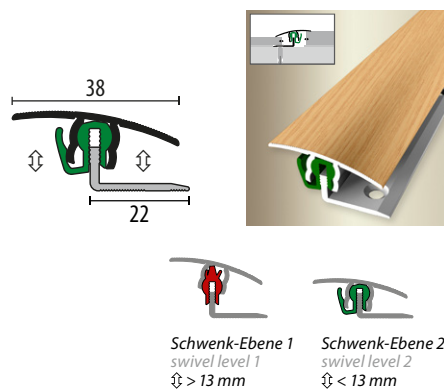

				0,9 m 2,7 m	SB	U	H
					•	•	•

DIGITAL
PRINT DECOR COATING
by Küberit

Preise finden Sie ab Seite / Prices are indicated on page 206



■ FCS®-718 Verlegeanleitung / Assembly Instruction



BASIS-Profil verdübeln und verschrauben (= Durchsteckmontage) bzw. bei Fußbodenheizung einen 2-Komponenten-Kleber verwenden.

Screw or anchor the **BASE profile** (= plug mounting). In case of underfloor heating, fasten the profile by using a two component adhesive.

Hartbodenbelag anpassen, dabei die vom Hersteller empfohlene **Dehnfuge** berücksichtigen!

Lay the hard floor covering and pay attention to the **expansion joint** as recommended by the flooring manufacturer!

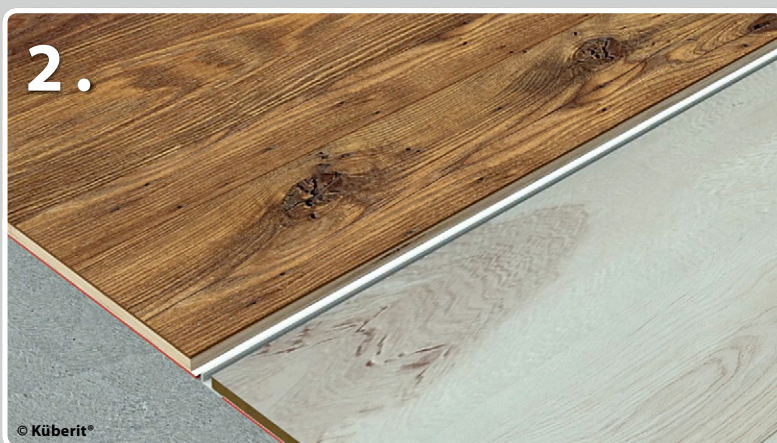

Adapter – je nach Bodenbelagsstärke – in Schwenkebene 1 oder 2 des **TOP-Profils** einschieben.

Depending on the height of the floor covering insert the adapter into swivel level 1 or 2 of the **TOP profile**.

Anwendungsbereich:

- grüner Adapter = 7 – 13 mm (Einschieben in die obere Ebene)
- roter Adapter = 13 – 18 mm (Einschieben in die untere Ebene)
- grauer Adapter = 7 – 18 mm (nur für Abschlussprofil 787)

Area of application:

- green adapter = 7 – 13 mm (insertion in the upper level)
- red adapter = 13 – 18 mm (insertion in the lower level)
- grey adapter = 7 – 18 mm (only for border profile 787)

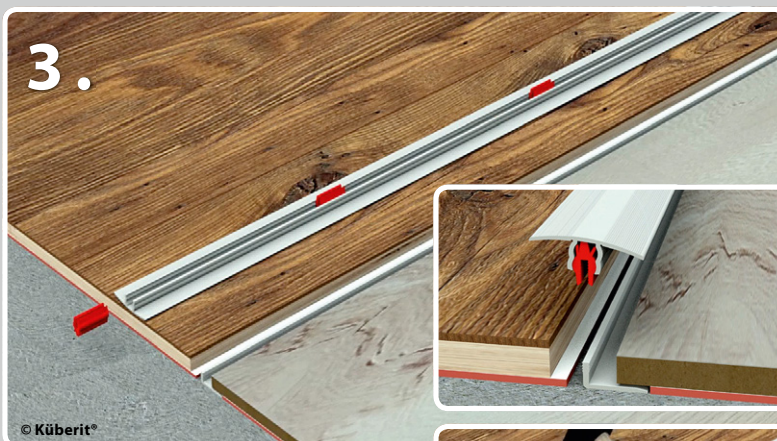
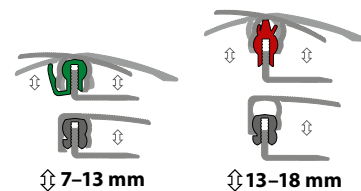

Höhendifferenzen mit wohldosierten Schlägen anpassen (Schlagklotz aus Hartholz mit Filz). Fertig ist die hochwertige Verlegung!

Adjust height differences with well controlled hammer blows (block of hardwood with felt). The high-quality installation is finished!



VIDEO

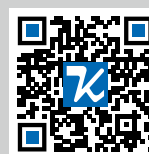

kueberit.com/qr/fcs

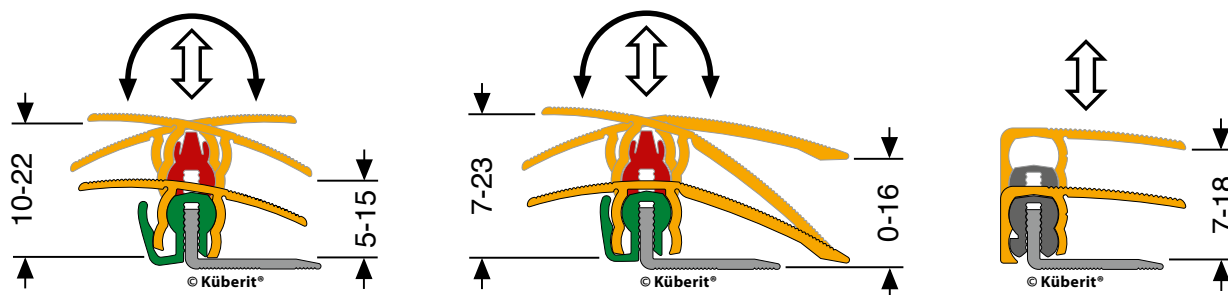

© Küberit®



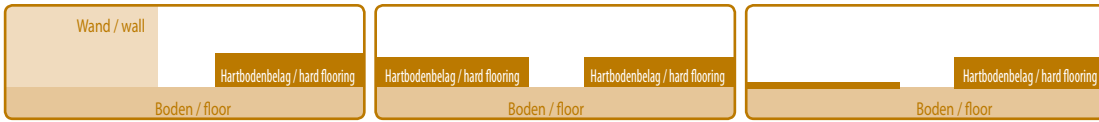

Euro-Clip®

Euro-Clip® XL

Euro-Clip® Plus



Euro-Clip® **Euro-Clip®^{XL}** **Euro-Clip®^{Plus}**



Mit **Euro-Clip®** entwickelte *Küberit* ein zweiteiliges Profilsystem für alle Hartbodenbeläge zum Clippen. Durch seine einzigartige Clip-Technik sowie die hochwertigen Ummantelungsmöglichkeiten ist **Euro-Clip®** ein optisch sehr attraktives und zugleich absolut sicheres Profilsystem für alle Hartbodenbeläge.

With **Euro-Clip®**, *Küberit* developed a two-part-system to clip for all hard floor coverings. Due to the unique clip technique and the high class wrapping possibilities, **Euro-Clip®** is a highly attractive and at the same time a safe profile system which can be used for all hard floor coverings.

Euro-Clip® – Durch seine einzigartige Clip-Technik sowie die hochwertigen Ummantlungsmöglichkeiten ist Euro-Clip® ein optisch sehr attraktives und zugleich absolut sicheres Profilsystem.

- Profilsystem zum Clippen
- einfache, leichte und zeitsparende Verlegung
- technisch einzigartige stabile Verbindung

erhältlich als:

ANPASSUNGSPROFIL (oder AUSGLEICHSPROFIL)
für alle Hartbodenbeläge an angrenzende, niedrigere Flächen oder Beläge

ABSCHLUSSPROFIL
für saubere Abschlüsse und Begrenzungen von Hartbodenbelägen vor höheren, angrenzenden Schwellen, Kacheln, Fliesen, Terrassentüren und -fenstern oder anderen Erhöhungen

ÜBERGANGSPROFIL (oder DEHNFUGENPROFIL)
für gleich hohe oder bis zu ± 2 mm unterschiedlich hohe Hartbodenbeläge

Euro-Clip® – Due to the unique clip technique and the high class coating possibilities, Euro-Clip® is a highly attractive and at the same time a safe profile system.

- Profile Clip-System
- simple, easy and timesaving installation
- unique technical solution and strong connection

available as:

ADAPTING PROFILE
(or LEVELING PROFILE / REDUCER PROFILE)
for all hard floor coverings bordering lower areas or floors

BORDER PROFILE
for neat borders of hard floor coverings in front of higher sills, tiles, terrace doors and windows or other raisings

CONNECTING PROFILE (or EXPANSION JOINT PROFILE)
for hard floor coverings of equal level or up to ± 2 mm difference in height

VIDEO



kueberit.com/qr/eclip

Zubehör / Accessories

Clip-Lifter 15

weiß, für Höhen von 11 – 15 mm
white, for thicknesses from
11 – 15 mm

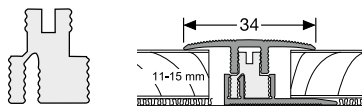

Clip-Lifter 20

grau, für Höhen von 16 – 20 mm
grey, for thicknesses from
16 – 20 mm

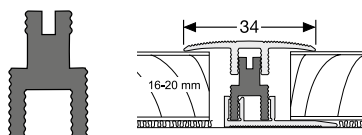

aus glasfaserverstärktem Kunststoff (GFK),
zur Basisprofilerhöhung
für 586L / 587L / 588L

made of glass-fiber reinforced plastic (GFRP),
for lifting the BASE profile
of 586L / 587L / 588L



© Küberit®



© Küberit®

Preise finden Sie ab Seite / Prices are indicated on page 208

■ Euro-Clip® Laminat / laminate

Artikel
article

Farbe
colour

Länge
length

Version
version

586 L

für Bodenbeläge von
for floor coverings from
⇄ 6 – 10 mm ⇄ 10 mm

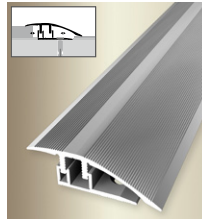
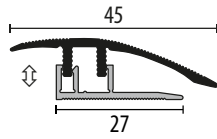

F2	F4	F5	F6	0,9 m 1,0 m 2,7 m 3,0 m	SB	U	H
F9					•	•	•
H20	H22	H30	H31		•	•	•
H33	H40	H61	H62		•	•	•
H63	H64	H80	H81				
H95							

587 L

für Bodenbeläge von
for floor coverings from
⇄ 6 – 10 mm ⇄ 10 mm

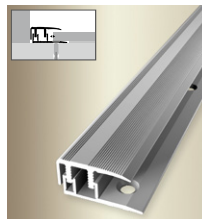
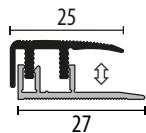

F2	F4	F5	F6	0,9 m 1,0 m 2,7 m 3,0 m	SB	U	H
F9					•	•	•
H20	H22	H30	H31		•	•	•
H33	H40	H61	H62		•	•	•
H63	H64	H80	H81				
H95							

588 L

für Bodenbeläge von
for floor coverings from
⇄ 6 – 10 mm ⇄ 2x 10 mm

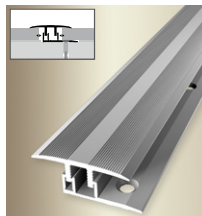
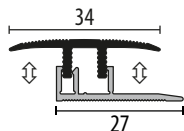

F2	F4	F5	F6	0,9 m 1,0 m 2,7 m 3,0 m	SB	U	H
F9					•	•	•
H20	H22	H30	H31		•	•	•
H33	H40	H61	H62		•	•	•
H63	H64	H80	H81				
H95							

Befestigung des BASIS-Profiles mit Torx-Schrauben
fastening of the BASE profile with Torx screws

Preise finden Sie ab Seite / Prices are indicated on page 206

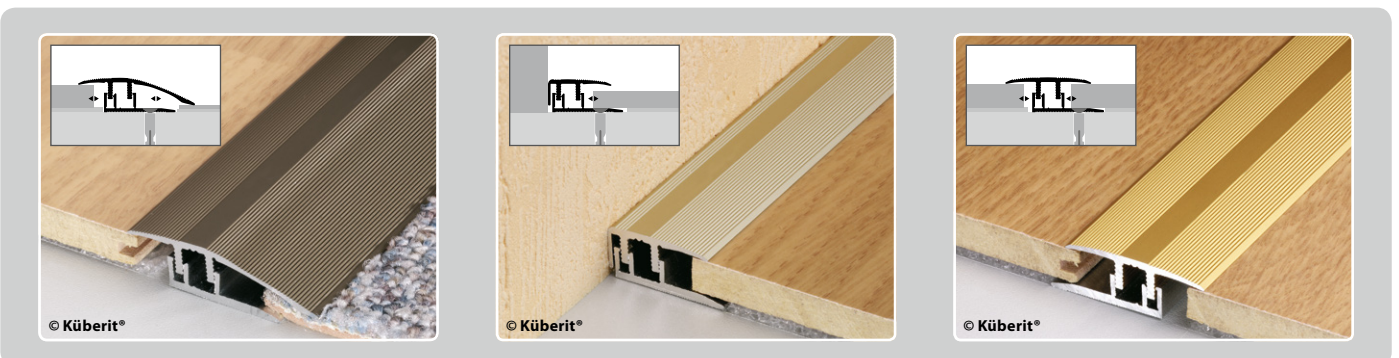

■ Euro-Clip® XL

Artikel
article

586 XL

für Bodenbeläge von
for floor coverings from
⇄ 8 – 12 mm ⇄ 10 mm

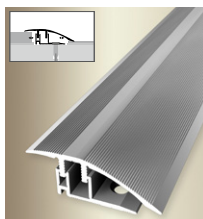
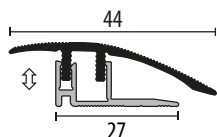

Farbe
colour

Länge
length

Version
version

F2	F4	F9		0,9 m	SB	U	H
H30	H33	H61	H62	1,0 m	•	•	•
H63	H64	H81		2,7 m	•	•	•
				3,0 m	•	•	•

DIGITAL PRINT DECOR COATING by Kübert

587 XL

für Bodenbeläge von
for floor coverings from
⇄ 8 – 12 mm ⇄ 10 mm

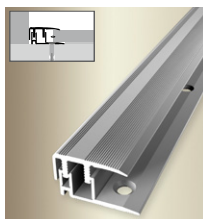
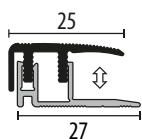

F2	F4	F9		0,9 m	SB	U	H
H30	H33	H61	H62	1,0 m	•	•	•
H63	H64	H81		2,7 m	•	•	•
				3,0 m	•	•	•

DIGITAL PRINT DECOR COATING by Kübert

588 XL

für Bodenbeläge von
for floor coverings from
⇄ 8 – 12 mm ⇄ 2x 10 mm

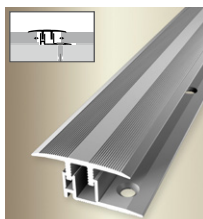
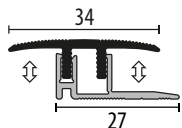

F2	F4	F9		0,9 m	SB	U	H
H30	H33	H61	H62	1,0 m	•	•	•
H63	H64	H81		2,7 m	•	•	•
				3,0 m	•	•	•

DIGITAL PRINT DECOR COATING by Kübert

Preise finden Sie ab Seite / Prices are indicated on page 207

■ Euro-Clip® Plus

Artikel
article

568

für Bodenbeläge von
for floor coverings from
⇄ 8 – 14 mm ⇄ 2x10 mm

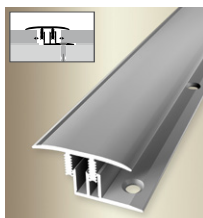
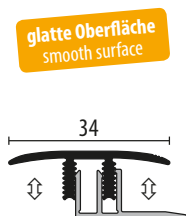

Farbe
colour

Länge
length

Version
version

F2G	F4	F6	F9	0,9 m	SB	U	
				1,0 m	•	•	
				2,7 m	•	•	
				3,0 m	•	•	

Preise finden Sie ab Seite / Prices are indicated on page 208



© Küberit®



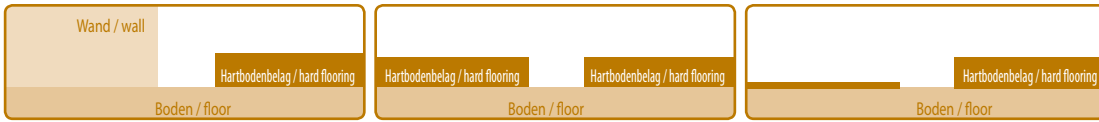

Mono-Clip



Mono-Clip

Mit dem zweiteiligen Profil-System **Mono-Clip** steht dem Verarbeiter ein System für Laminat-, Parkett- und Starkparkett zur Verfügung, das durch seinen sehr schmalen Aufbau zierlich erscheint und gleichzeitig eine Dehnfuge von 13 mm ermöglicht. Die neue, kraftschlüssige Clip-Technik macht den Einbau komfortabler, schneller und sicherer als andere Systeme. **Mono-Clip** ist für alle Hartbodenbeläge von 7 bis 22 mm geeignet und besticht durch seine edle Optik - glatte Oberfläche und keine sichtbaren Schrauben.

With the two-part profile system **Mono-Clip**, the professional installer has a system for laminate, parquet and thick parquet at his disposal. Even with its narrow structure and slender appearance, it allows an expansion joint of 13 mm. The new, friction-locked clip technology makes installation more convenient, faster and safer than other systems. **Mono-Clip** is suitable for all hard floor coverings from 7 to 22 mm and impresses with its elegant appearance - smooth surface and no visible screws.



■ Mono-Clip

Artikel
article

556

für Bodenbeläge von
for floor coverings from
↕ 7 – 12 mm ↔ 13 mm

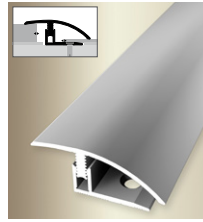
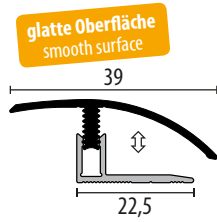

Farbe
colour

Länge
length

Version
version

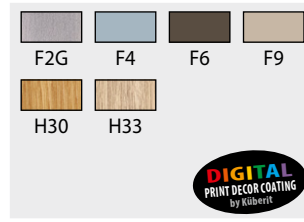

1,0 m	SB	U	H
2,0 m	•	•	•
3,0 m	•	•	•

557

für Bodenbeläge von
for floor coverings from
↕ 7 – 12 mm ↔ 13 mm

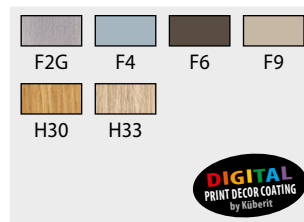
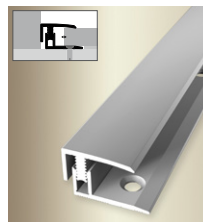
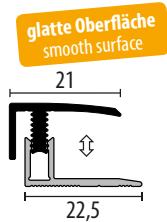

1,0 m	SB	U	H
2,0 m	•	•	•
3,0 m	•	•	•

558

für Bodenbeläge von
for floor coverings from
↕ 7 – 12 mm ↔ 13 mm

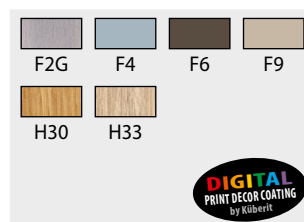
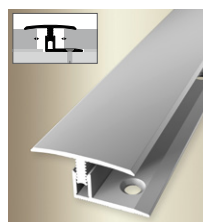
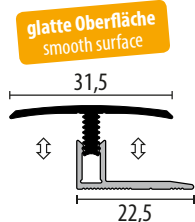

1,0 m	SB	U	H
2,0 m	•	•	•
3,0 m	•	•	•

Preise finden Sie ab Seite / Prices are indicated on page 209

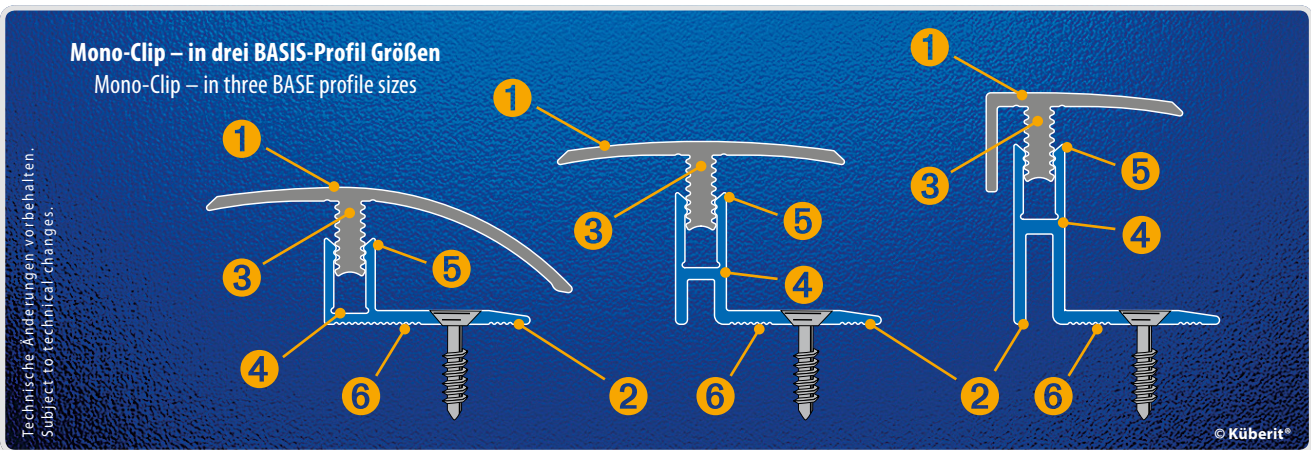

Technische Änderungen vorbehalten.
Subject to technical changes.

© Küberit®

Mono-Clip

- 1 TOP-Profil
- 2 BASIS-Profil (**drei Größen**)
Befestigung mit TORX-Schraube
(Verdübelung neben der Estrichfuge)
- 3 Führungssteg mit Sicherheitsrastung
- 4 Sollbiegestelle
- 5 Kontersteg mit 2-Punkt-Verzahnung
- 6 Kleberrillen (Verklebung bei Fußbodenheizung)

Mono-Clip

- 1 TOP profile
- 2 BASE profile (**three sizes**)
fastening with TORX screws
(anchor alongside the subfloor joint)
- 3 positive-engagement guide strip
- 4 predetermined bending point
- 5 counter edge with 2-point-interlock system
- 6 fluted for glueing (glue in case of underfloor heating)



Digitaldruck möglich - bitte sprechen Sie uns an Digital printing possible - please contact us

■ Mono-Clip

Artikel
article

559

für Bodenbeläge von
for floor coverings from
⇄ 12–17 mm ◀▶ 13 mm

glatte Oberfläche
smooth surface

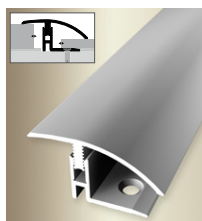
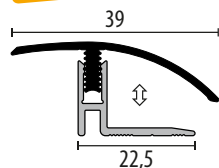

Farbe
colour

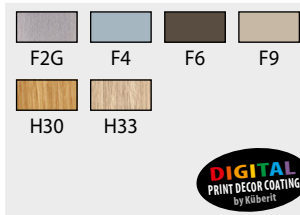

Länge
length

1,0 m
2,0 m
3,0 m

Version
version

SB	U	H
•	•	•
•	•	•
•	•	•

560

für Bodenbeläge von
for floor coverings from
⇄ 12–17 mm ◀▶ 13 mm

glatte Oberfläche
smooth surface

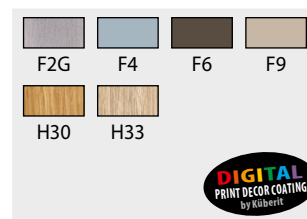
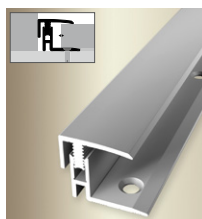
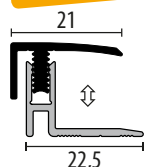

1,0 m
2,0 m
3,0 m

SB	U	H
•	•	•
•	•	•
•	•	•

561

für Bodenbeläge von
for floor coverings from
⇄ 12–17 mm ◀▶ 2x 13 mm

glatte Oberfläche
smooth surface

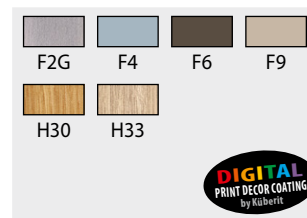
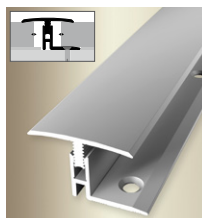
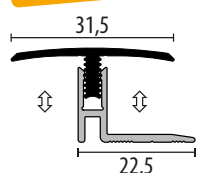

1,0 m
2,0 m
3,0 m

SB	U	H
•	•	•
•	•	•
•	•	•

562

für Bodenbeläge von
for floor coverings from
⇄ 17–22 mm ◀▶ 13 mm

glatte Oberfläche
smooth surface

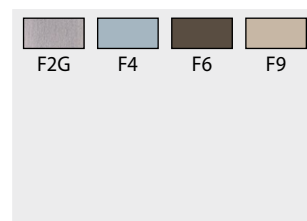
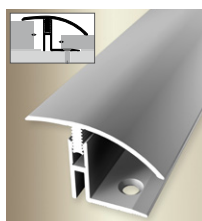
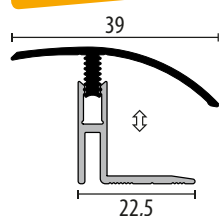

1,0 m
2,0 m
3,0 m

SB	U
•	•
•	•
•	•

563

für Bodenbeläge von
for floor coverings from
⇄ 17–22 mm ◀▶ 13 mm

glatte Oberfläche
smooth surface

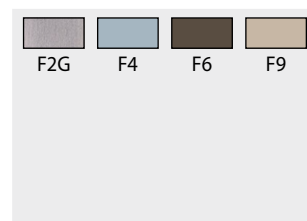
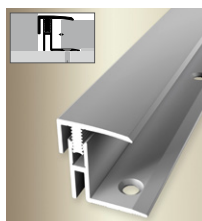
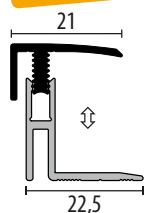

1,0 m
2,0 m
3,0 m

SB	U
•	•
•	•
•	•

564

für Bodenbeläge von
for floor coverings from
⇄ 17–22 mm ◀▶ 2x 13 mm

glatte Oberfläche
smooth surface

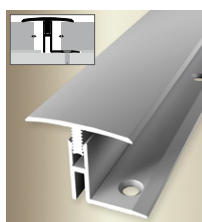
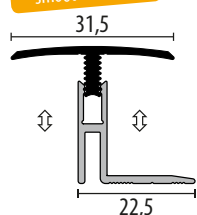

1,0 m
2,0 m
3,0 m

SB	U
•	•
•	•
•	•

Preise finden Sie ab Seite / Prices are indicated on page 209



TORX!

Euro-Step® Champion / Euro-Step® Star

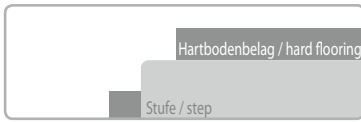

Euro-Step® Champion



Euro-Step® Star



Champion
Euro-Step®

Star
Euro-Step®

Für die Renovierung alter Holzstufen mit Parkett, Laminat oder LVT-Böden bietet *Küberit* das Treppenkantenprofilensystem **Euro-Step® Champion** und **Euro-Step® Star**. Bei einer variablen Einbauhöhe ist das System sowohl für den Laminat-, Parkett- als auch für den LVT-Bereich einsetzbar und kann zudem bei geraden und gewendelten Treppen- und Podestverläufen eingebaut werden. Für offene Treppen steht ein passender Blendwinkel zur Verfügung.

For the renovation of worn-out stairs with parquet, laminate and LVT flooring, *Küberit* offers the stair nosing profile system **Euro-Step® Champion** and **Euro-Step® Star**. With a variable installation height, the system is suitable for laminate, parquet as well as for LVT flooring. Besides a straight installation, the system can also be used for spiral staircases and podiums. For open stairs a matching facing edge is also available.



■ Euro-Step® Champion



320

für Bodenbeläge von
for floor coverings from
↕ 7 – 16 mm ↔ 12 mm

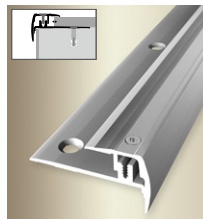
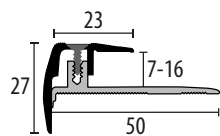

F2	F4	F5	F6			
F9						
				1,0 m	SB	V
				2,7 m	•	•
				3,0 m	•	•
				2,9		

Preise finden Sie ab Seite / Prices are indicated on page 210

Nur bei 7 – 9 mm starken Bodenbelägen auf die passgenaue Ausrichtung der längeren Schenkel vom TOP-Profil zur Verschiebenut des BASIS-Profils achten. Verschrauben - fertig!

For floor coverings of 7 – 9 mm thickness, make sure, that the long side of the TOP profile is in the exact position to the sliding grooves of the BASE profile. Screw it down – finished!

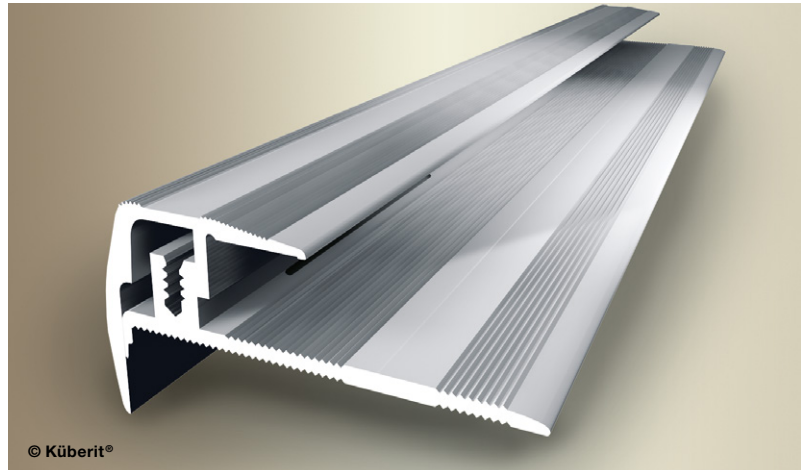

■ Montage-Winkel für Treppenkantensysteme / Mounting angle for stair nosing systems

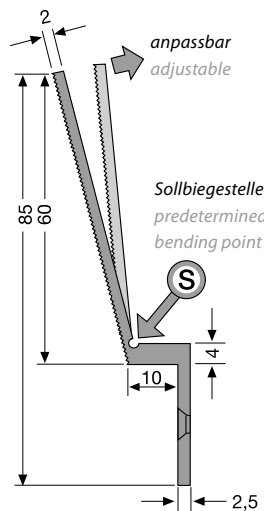

Schräg-Winkel 402

Aluminium, naturfarbig
 Härte ca. 75 N / mm²
 mit umlaufenden Kleberillen,
 mit versenkten Bohrungen,
 Holzschrauben mit Kreuzschlitz
 Ø 3,5 x 20 mm liegen bei,
 Längen: 0,9 m / 1,0 m / 2,7 m / 3,0 m

Angled Edge 402

aluminium, natural colour
 hardness approx. 75 N / mm²
 fluted for glueing,
 countersunk drilled,
 with pozidriv wood screws 3,5 Ø x 20 mm
 available lengths:
 0,9 m / 1,0 m / 2,7 m / 3,0 m

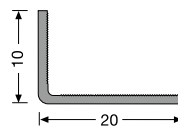
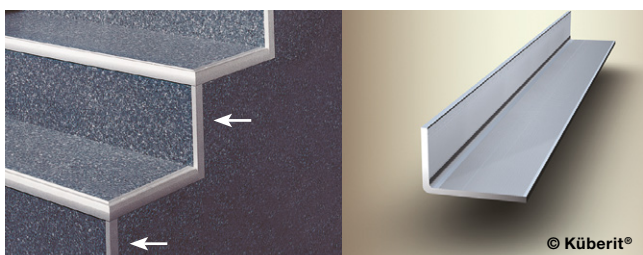

Blend-Winkel 401

ungebohrt,
 Rillen innen zum Verkleben,
 erhältliche Längen:
 1,0 m (nur Holzdekore) / 3,0 m

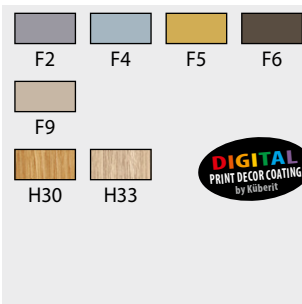

Facing Edge 401

undrilled,
 fluted inside for glueing
 available lengths:
 1,0 m (only wood decors) / 3,0 m

EB = Ø min 70 cm

Preise finden Sie ab Seite / Prices are indicated on page 210

■ Verlegeanleitung / Installation Instructions



Montagekleber auf die Setzstufe auftragen und den zugeschnittenen Bodenbelag anbringen.

Apply the glue on the riser, then put the floor covering on the riser.



BASE-Profil zuschneiden, mit der Anschlagkante an den Bodenbelag schieben, die Bohrlöcher markieren, bohren, dübeln und dann verschrauben. Kleber auftragen und den Bodenbelag verkleben. Dehnfuge berücksichtigen!

Trim the **BASE profile** to the required length, adjust the **BASE profile** with the limit-edge against the floor covering position on the riser and drill, anchor and install it. Trim the floor covering and glue it on the tread. Mind the expansion joint!



TOP-Profil zuschneiden, dabei auf die passgenaue Ausrichtung der längeren Schenkel vom **TOP-Profil** zur Verschiebenut des **BASE-Profils** achten. **TOP-Profil** verschrauben.

Trim the **TOP profile** to the required length and pay attention that the longer legs below the **TOP profile** fit into the punching of the **BASE profile**. Please also pay attention to a visually uniform drilling pattern on each step.



Fertig ist die sichere Stufenkante.

A safe stair edge is ready.

VIDEO



kueberit.com/qr/estst

■ Euro-Step® Star

Artikel article

325

für LVT-Designbeläge von
for LVT floor coverings from
↕ 4–9 mm ↔ 8 mm

für Teppichböden von
for carpet floors from
↕ 5–12 mm

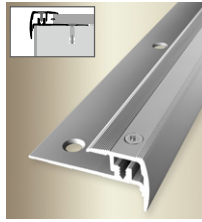
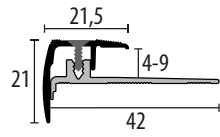

Farbe colour

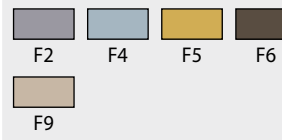

Länge length

1,0 m
2,7 m
3,0 m

Version version

SB
•
•
•

V
•
•
•



Preise finden Sie ab Seite / Prices are indicated on page 210

Blendwinkel auf Seite 167
Facing Edge on page 167





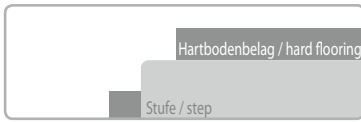

Step-Clip Champion



Champion Step-Clip®

Das Treppenkantenprofilssystem **Step-Clip Champion** ist aufgrund der Champion-Technologie mit Verschiebenut für Materialstärken von 7 – 14 mm anpassbar. Während das BASIS-Profil fest mit dem Untergrund verschraubt wird, wird das TOP-Profil mit glatter Oberfläche schnell und bequem auf den Laminat-, Kork- oder Parkettboden aufgeclippt.

Mit dem Treppenkantenprofilssystem können optisch ansprechende Treppenrenovierungen mit Parkett oder Laminat bei Bodenbelagsstärken von 7 – 14 mm durch zwei Profile ohne Schrauben realisiert werden.

The stair nosing profile system **Step-Clip Champion** can be used for materials with a thickness of 7 – 14 mm. With the patented champion-technology you achieve a unique adjustment. The BASE profile is screwed to the subfloor and the TOP profile with a smooth surface can be clipped on the laminate-, cork-, or parquet-floor quickly and easily.

With the examined stair nosing profile system you will always achieve a decorative look for the stairs. It is suitable for stair renovation of parquet and laminate from 7 – 14 mm by two profiles without any screws.



■ Step-Clip Champion

- schraubenloses Verlegen durch einfaches Clipsystem
- Sicherheit an der Stufenkante
- leicht verlegbar
- einfache, zeitsparende Verlegung
- universell anpassbar für Materialstärken von 7 – 14 mm
- problemlos einsetzbar auch bei gewendelten Treppen und für Podeste
- dekorative, gediegene, zeitlose Gesamtwirkung der Treppen
- Montage-Winkel und Schrägwinkel verfügbar
- Blendwinkel auch mit Holzdekor ummantelt erhältlich
- Befestigung des BASIS-Profiles mit Torx-Schrauben
- screwless installation due to the easy clip system
- safe and stable staircase
- easy to install
- simple, timesaving installation
- universally adjustable to floors of 7 – 14 mm thickness
- can be used for spiral staircases and podiums
- decorative and timeless, solid look of the stairs
- mounting edge and angled edge available
- facing angles also available with wood decors
- fastening of the BASE profile with Torx screws

Artikel article

510

für Bodenbeläge von
for floor coverings from

↕ 7 – 14 mm ↔ 14 mm

glatte Oberfläche
smooth surface

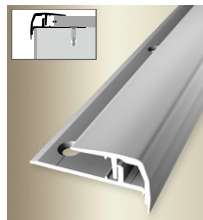
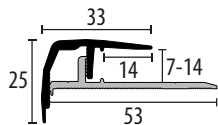

Farbe colour



Länge length

1,0 m
3,0 m

Version version

SB	U	H
•	•	•
•	•	•



Preise finden Sie ab Seite / Prices are indicated on page 210

Blendwinkel auf Seite 161
Facing Edge on page 161

Befestigung des BASIS-Profiles mit Torx-Schrauben
fastening of the BASE profile with Torx screws

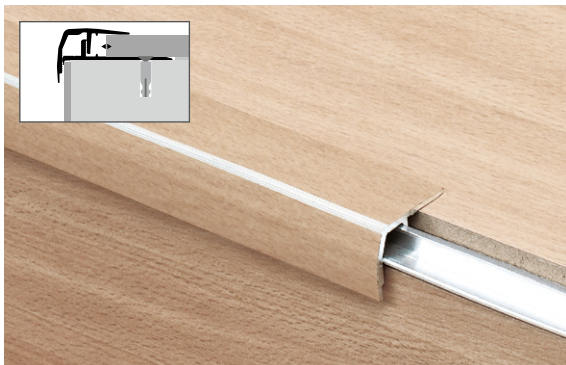



VIDEO



kueberit.com/qr/stcch



Preisliste / Price list

Alle SBS-verpackten Profile sind komplett mit Schrauben und Dübel erhältlich.

Sie haben die Möglichkeit, unsere Schraubbeutel mit jeweils 6 Schrauben und Dübeln in den passenden Farben zusätzlich als Einzelartikel zu bekommen.

Für eine Kurzlänge (0,9 oder 1,0 m) wird ein Schraubbeutel benötigt,

für eine Langlänge das Vielfache davon (z. B. 2,7 m Länge = 3 Beutel oder 5,0 m Länge = 5 Beutel).

Den richtigen Schraubendurchmesser (3,0 oder 3,5 mm) entnehmen Sie bitte dem Hinweis bei der Produktabbildung.

All SBS-packed profiles are available complete with screws and dowels.

Hardware packages with 6 matching screws and anchors may be purchased separately.

For shorter lengths (0,9 or 1,0 m) one hardware package is required.

For longer lengths, multiple hardware packages are needed (i.e. 2,7 m = 3 hardware packages or 5 m = 5 hardware packages).

For the correct screw diameter (3,0 or 3,5 mm) please see the instructions by the product illustration.

Schraubbeutel / Screw hardware packages

3,0 mm x 25 mm:

303 27 048 – F4 / F3 – 0,20 EUR/Bt.

303 27 058 – F5 – 0,20 EUR/Bt.

303 27 068 – F6 – 0,20 EUR/Bt.

303 27 098 – F9 / F2 – 0,20 EUR/Bt.

Schraubbeutel / Screw hardware packages

3,5 mm x 30 mm:

303 27 148 – F4 / F3 – 0,25 EUR/Bt.

303 27 158 – F5 – 0,25 EUR/Bt.

303 27 168 – F6 – 0,25 EUR/Bt.

303 27 198 – F9 / F2 – 0,25 EUR/Bt.

Bei den aufgeführten Preisen handelt es sich um Stückpreise exkl. sowie inkl. der gesetzlichen Mehrwertsteuer.

Alle Preise sind unverbindliche Preisempfehlungen des Herstellers.

Bitte beachten Sie, dass die Profile in 0,9 und 1,0 m Länge auf den folgenden Seiten ggf. nur in vollen Verpackungseinheiten erhältlich sind.

Fragen Sie hierzu Ihren Küberit-Fachhändler.

All prices are quoted per piece. The prices are non-binding manufacturer recommendations and are quoted inclusive and exclusive of VAT.

Please note that the profiles with a length of 0.9 m and 1.0 m shown on the next pages are only available as packaged units.

For further information please contact us.



Übergangsprofile Aluminium
Aluminium Connecting Profiles

Artikel	Farben	Länge	Version	Preis/Stück	unit price	Bestell-Nr.
article	colour	length	version	exkl. MwSt.	inkl. MwSt.	order no.
				excl. VAT	incl. VAT	
458	F3	5,0 m	U	€ 32,50	€ 38,70	211 58 037
		2,7 m	U	€ 17,60	€ 20,95	211 58 035
		1,0 m	U	€ 7,00	€ 8,35	211 58 031
	F4	5,0 m	U	€ 32,50	€ 38,70	211 58 047
		2,7 m	U	€ 17,60	€ 20,95	211 58 045
	F5	1,0 m	U	€ 7,00	€ 8,35	211 58 041
		5,0 m	U	€ 35,00	€ 41,65	211 58 057
	F9	2,7 m	U	€ 18,90	€ 22,50	211 58 055
		1,0 m	U	€ 7,60	€ 9,05	211 58 051
	F6	5,0 m	U	€ 35,00	€ 41,65	211 58 067
		2,7 m	U	€ 18,90	€ 22,50	211 58 065
	F2G	1,0 m	U	€ 7,60	€ 9,05	211 58 061
		5,0 m	U	€ 40,00	€ 47,60	211 58 027
	F3	2,7 m	U	€ 21,60	€ 25,70	211 58 025
		1,0 m	U	€ 8,70	€ 10,35	211 58 021
	F4	5,0 m	M	€ 34,50	€ 41,05	312 58 037
		2,7 m	M	€ 18,60	€ 22,15	312 58 035
	F5	1,0 m	M	€ 7,40	€ 8,80	312 58 031
		0,9 m	M	€ 6,60	€ 7,85	312 58 030
	F6	5,0 m	M	€ 34,50	€ 41,05	312 58 047
		2,7 m	M	€ 18,60	€ 22,15	312 58 045
	F9	1,0 m	M	€ 7,40	€ 8,80	312 58 041
		0,9 m	M	€ 6,60	€ 7,85	312 58 040
	F5	5,0 m	M	€ 37,00	€ 44,05	312 58 057
		2,7 m	M	€ 20,00	€ 23,80	312 58 055
	F9	1,0 m	M	€ 8,00	€ 9,50	312 58 051
		0,9 m	M	€ 7,20	€ 8,55	312 58 050
	F6	5,0 m	M	€ 34,50	€ 41,05	312 58 097
		2,7 m	M	€ 18,60	€ 22,15	312 58 095
	F9	1,0 m	M	€ 7,40	€ 8,80	312 58 091
		0,9 m	M	€ 6,60	€ 7,85	312 58 090
	F6	5,0 m	M	€ 37,00	€ 44,05	312 58 067
		2,7 m	M	€ 20,00	€ 23,80	312 58 065
	F2G	1,0 m	M	€ 8,00	€ 9,50	312 58 061
		0,9 m	M	€ 7,20	€ 8,55	312 58 060
	F2G	5,0 m	M	€ 42,00	€ 50,00	312 58 027
		2,7 m	M	€ 22,70	€ 27,00	312 58 025
	F3	1,0 m	M	€ 9,10	€ 10,85	312 58 021
		0,9 m	M	€ 7,80	€ 9,30	312 58 020
	442	F3	3,0 m	M	€ 26,10	€ 31,05
1,0 m			M	€ 8,90	€ 10,60	312 442 003 1
F4	3,0 m	M	€ 26,10	€ 31,05	312 442 004 8	
	1,0 m	M	€ 8,90	€ 10,60	312 442 004 1	
F4G	3,0 m	M	€ 31,50	€ 37,50	312 442 804 8	
F9	1,0 m	M	€ 10,70	€ 12,75	312 442 804 1	
	3,0 m	M	€ 26,10	€ 31,05	312 442 009 8	
F2G	1,0 m	M	€ 8,90	€ 10,60	312 442 009 1	
	3,0 m	M	€ 31,50	€ 37,50	312 442 002 8	
F1G	1,0 m	M	€ 10,70	€ 12,75	312 442 002 1	
	3,0 m	M	€ 33,60	€ 40,00	312 442 801 8	
F3	1,0 m	M	€ 11,40	€ 13,55	312 442 801 1	
	3,0 m	SK	€ 28,80	€ 34,25	215 442 003 8	
F4	1,0 m	SK	€ 9,80	€ 11,65	215 442 003 1	
	3,0 m	SK	€ 28,80	€ 34,25	215 442 004 8	
F4G	1,0 m	SK	€ 9,80	€ 11,65	215 442 004 1	
	3,0 m	SK	€ 33,60	€ 40,00	215 442 804 8	
F9	1,0 m	SK	€ 11,40	€ 13,55	215 442 804 1	
	3,0 m	SK	€ 28,80	€ 34,25	215 442 009 8	
		1,0 m	SK	€ 9,80	€ 11,65	215 442 009 1

Artikel	Farben	Länge	Version	Preis/Stück	unit price	Bestell-Nr.
article	colour	length	version	exkl. MwSt.	inkl. MwSt.	order no.
				excl. VAT	incl. VAT	
F2G		3,0 m	SK	€ 33,60	€ 40,00	215 442 002 8
		1,0 m	SK	€ 11,40	€ 13,55	215 442 002 1
F1G		3,0 m	SK	€ 35,70	€ 42,50	215 442 801 8
		1,0 m	SK	€ 12,20	€ 14,50	215 442 801 1
RAL9016		3,0 m	SK	€ 34,20	€ 40,70	215 442 715 8
		1,0 m	SK	€ 11,60	€ 13,80	215 442 715 1
RAL9005		3,0 m	SK	€ 34,20	€ 40,70	215 442 701 8
		1,0 m	SK	€ 11,60	€ 13,80	215 442 701 1
459	F3	5,0 m	M	€ 42,00	€ 50,00	312 59 037
		2,7 m	M	€ 22,70	€ 27,00	312 59 035
		1,0 m	M	€ 8,70	€ 10,35	312 59 031
	F4	0,9 m	M	€ 8,00	€ 9,50	312 59 030
		5,0 m	M	€ 42,00	€ 50,00	312 59 047
		2,7 m	M	€ 22,70	€ 27,00	312 59 045
	F4G	1,0 m	M	€ 8,70	€ 10,35	312 59 041
		0,9 m	M	€ 8,00	€ 9,50	312 59 040
	F5	3,0 m	M	€ 31,20	€ 37,15	312 459 804 8
		1,0 m	M	€ 10,90	€ 12,95	312 459 804 1
	F9	5,0 m	M	€ 45,50	€ 54,15	312 59 057
		2,7 m	M	€ 24,60	€ 29,25	312 59 055
F6	1,0 m	M	€ 9,80	€ 11,65	312 59 051	
	0,9 m	M	€ 8,90	€ 10,60	312 59 050	
F9	5,0 m	M	€ 42,00	€ 50,00	312 59 097	
	2,7 m	M	€ 22,70	€ 27,00	312 59 095	
F6	1,0 m	M	€ 8,70	€ 10,35	312 59 091	
	0,9 m	M	€ 8,00	€ 9,50	312 59 090	
F2G	5,0 m	M	€ 45,50	€ 54,15	312 59 067	
	2,7 m	M	€ 24,60	€ 29,25	312 59 065	
F5	1,0 m	M	€ 9,80	€ 11,65	312 59 061	
	0,9 m	M	€ 8,90	€ 10,60	312 59 060	
F1G	5,0 m	M	€ 52,00	€ 61,90	312 59 027	
	2,7 m	M	€ 28,10	€ 33,45	312 59 025	
F3	1,0 m	M	€ 10,90	€ 12,95	312 59 021	
	0,9 m	M	€ 10,10	€ 12,00	312 59 020	
F4G	3,0 m	M	€ 33,30	€ 39,65	312 459 801 8	
	1,0 m	M	€ 11,60	€ 13,80	312 459 801 1	
F3	5,0 m	SK	€ 45,00	€ 53,55	215 59 037	
	2,7 m	SK	€ 24,30	€ 28,90	215 59 035	
F4	1,0 m	SK	€ 9,80	€ 11,65	215 59 031	
	0,9 m	SK	€ 8,70	€ 10,35	215 59 030	
F4G	5,0 m	SK	€ 45,00	€ 53,55	215 59 047	
	2,7 m	SK	€ 24,30	€ 28,90	215 59 045	
F5	1,0 m	SK	€ 9,80	€ 11,65	215 59 041	
	0,9 m	SK	€ 8,70	€ 10,35	215 59 040	
F6	3,0 m	SK	€ 33,90	€ 40,35	215 459 804 8	
	1,0 m	SK	€ 11,70	€ 13,90	215 459 804 1	
F5	5,0 m	SK	€ 50,50	€ 60,10	215 59 057	
	2,7 m	SK	€ 27,30	€ 32,50	215 59 055	
F9	1,0 m	SK	€ 10,80	€ 12,85	215 59 051	
	0,9 m	SK	€ 9,80	€ 11,65	215 59 050	
F6	5,0 m	SK	€ 45,00	€ 53,55	215 59 097	
	2,7 m	SK	€ 24,30	€ 28,90	215 59 095	
F9	1,0 m	SK	€ 9,80	€ 11,65	215 59 091	
	0,9 m	SK	€ 8,70	€ 10,35	215 59 090	
F6	5,0 m	SK	€ 50,50	€ 60,10	215 59 067	
	2,7 m	SK	€ 27,30	€ 32,50	215 59 065	
F2G	1,0 m	SK	€ 10,80	€ 12,85	215 59 061	
	0,9 m	SK	€ 9,80	€ 11,65	215 59 060	
F2G	5,0 m	SK	€ 56,50	€ 67,25	215 59 027	
	2,7 m	SK	€ 30,50	€ 36,30	215 59 025	
F1G	1,0 m	SK	€ 11,70	€ 13,90	215 59 021	
	0,9 m	SK	€ 10,80	€ 12,85	215 59 020	
F15 RAL9016	3,0 m	SK	€ 36,00	€ 42,85	215 459 801 8	
	1,0 m	SK	€ 12,50	€ 14,90	215 459 801 1	
F16 RAL9005	2,7 m	SK	€ 29,70	€ 35,35	215 459 715 5	
	0,9 m	SK	€ 10,70	€ 12,75	215 459 715 0	
H20		2,7 m	SK	€ 32,70	€ 38,90	215 59 205
H22		0,9 m	SK	€ 11,20	€ 13,35	215 59 200
		2,7 m	SK	€ 32,70	€ 38,90	215 59 225
H30		0,9 m	SK	€ 11,20	€ 13,35	215 59 220
		2,7 m	SK	€ 32,70	€ 38,90	215 59 305
H31		0,9 m	SK	€ 11,20	€ 13,35	215 59 300
		2,7 m	SK	€ 32,70	€ 38,90	215 59 315
H33		0,9 m	SK	€ 11,20	€ 13,35	215 59 310
		2,7 m	SK	€ 32,70	€ 38,90	215 59 335
H34		0,9 m	SK	€ 11,20	€ 13,35	215 59 330
		2,7 m	SK	€ 32,70	€ 38,90	215 59 345
H40		0,9 m	SK	€ 11,20	€ 13,35	215 59 340
		2,7 m	SK	€ 32,70	€ 38,90	215 59 405
H61		0,9 m	SK	€ 11,20	€ 13,35	215 59 400
		2,7 m	SK	€ 32,70	€ 38,90	215 59 615
H62		0,9 m	SK	€ 11,20	€ 13,35	215 59 610
		2,7 m	SK	€ 32,70	€ 38,90	215 59 625

Artikel	Farben	Länge	Version	Preis/Stück	unit price	Bestell-Nr.	Artikel	Farben	Länge	Version	Preis/Stück	unit price	Bestell-Nr.	
article	colour	length	version	exkl. MwSt.	inkl. MwSt.	order no.	article	colour	length	version	exkl. MwSt.	inkl. MwSt.	order no.	
		0,9 m	SK	€ 11,20	€ 13,35	215 59 620			3,0 m	M	€ 40,50	€ 48,20	312 441 006 8	
	H63	2,7 m	SK	€ 32,70	€ 38,90	215 59 635			2,7 m	M	€ 36,50	€ 43,45	312 441 006 5	
		0,9 m	SK	€ 11,20	€ 13,35	215 59 630			1,0 m	M	€ 13,70	€ 16,30	312 441 006 1	
	H64	2,7 m	SK	€ 32,70	€ 38,90	215 59 645			0,9 m	M	€ 12,70	€ 15,10	312 441 006 0	
		0,9 m	SK	€ 11,20	€ 13,35	215 59 640		F2G	5,0 m	M	€ 75,00	€ 89,25	312 441 002 7	
	H65	2,7 m	SK	€ 32,70	€ 38,90	215 59 655			3,0 m	M	€ 45,30	€ 53,90	312 441 002 8	
		0,9 m	SK	€ 11,20	€ 13,35	215 59 650			2,7 m	M	€ 40,80	€ 48,55	312 441 002 5	
	H80	2,7 m	SK	€ 32,70	€ 38,90	215 59 805			1,0 m	M	€ 15,30	€ 18,20	312 441 002 1	
		0,9 m	SK	€ 11,20	€ 13,35	215 59 800			0,9 m	M	€ 14,10	€ 16,80	312 441 002 0	
	H81	2,7 m	SK	€ 32,70	€ 38,90	215 59 835		F3	5,0 m	SK	€ 68,50	€ 81,50	215 441 003 7	
		0,9 m	SK	€ 11,20	€ 13,35	215 59 830			3,0 m	SK	€ 41,10	€ 48,90	215 441 003 8	
	H95	2,7 m	SK	€ 32,70	€ 38,90	215 59 955			2,7 m	SK	€ 37,00	€ 44,05	215 441 003 5	
		0,9 m	SK	€ 11,20	€ 13,35	215 59 950			1,0 m	SK	€ 13,90	€ 16,55	215 441 003 1	
460	F3	5,0 m	M	€ 51,50	€ 61,30	312 60 037			0,9 m	SK	€ 13,50	€ 16,05	215 441 003 0	
		2,7 m	M	€ 27,80	€ 33,10	312 60 035			5,0 m	SK	€ 68,50	€ 81,50	215 441 004 7	
		1,0 m	M	€ 10,80	€ 12,85	312 60 031		F4	3,0 m	SK	€ 41,10	€ 48,90	215 441 004 8	
		0,9 m	M	€ 10,00	€ 11,90	312 60 030			2,7 m	SK	€ 37,00	€ 44,05	215 441 004 5	
	F4	5,0 m	M	€ 51,50	€ 61,30	312 60 047			1,0 m	SK	€ 13,90	€ 16,55	215 441 004 1	
		2,7 m	M	€ 27,80	€ 33,10	312 60 045			0,9 m	SK	€ 13,50	€ 16,05	215 441 004 0	
		1,0 m	M	€ 10,80	€ 12,85	312 60 041		F5	5,0 m	SK	€ 73,00	€ 86,85	215 441 005 7	
		0,9 m	M	€ 10,00	€ 11,90	312 60 040			3,0 m	SK	€ 43,80	€ 52,10	215 441 005 8	
	F5	5,0 m	M	€ 56,00	€ 66,65	312 60 057			2,7 m	SK	€ 39,40	€ 46,90	215 441 005 5	
		2,7 m	M	€ 30,20	€ 35,95	312 60 055			1,0 m	SK	€ 14,80	€ 17,60	215 441 005 1	
		1,0 m	M	€ 11,50	€ 13,70	312 60 051			0,9 m	SK	€ 13,90	€ 16,55	215 441 005 0	
		0,9 m	M	€ 10,50	€ 12,50	312 60 050		F9	5,0 m	SK	€ 68,50	€ 81,50	215 441 009 7	
	F9	5,0 m	M	€ 51,50	€ 61,30	312 60 097			3,0 m	SK	€ 41,10	€ 48,90	215 441 009 8	
		2,7 m	M	€ 27,80	€ 33,10	312 60 095			2,7 m	SK	€ 37,00	€ 44,05	215 441 009 5	
		1,0 m	M	€ 10,80	€ 12,85	312 60 091			1,0 m	SK	€ 13,90	€ 16,55	215 441 009 1	
		0,9 m	M	€ 10,00	€ 11,90	312 60 090			0,9 m	SK	€ 13,50	€ 16,05	215 441 009 0	
	F6	5,0 m	M	€ 56,00	€ 66,65	312 60 067		F6	5,0 m	SK	€ 73,00	€ 86,85	215 441 006 7	
		2,7 m	M	€ 30,20	€ 35,95	312 60 065			3,0 m	SK	€ 43,80	€ 52,10	215 441 006 6	
		1,0 m	M	€ 11,50	€ 13,70	312 60 061			2,7 m	SK	€ 39,40	€ 46,90	215 441 006 5	
		0,9 m	M	€ 10,50	€ 12,50	312 60 060			1,0 m	SK	€ 14,80	€ 17,60	215 441 006 1	
	F2G	5,0 m	M	€ 63,00	€ 74,95	312 60 027			0,9 m	SK	€ 13,90	€ 16,55	215 441 006 0	
		2,7 m	M	€ 34,00	€ 40,45	312 60 025		F2G	5,0 m	SK	€ 80,00	€ 95,20	215 441 002 7	
		1,0 m	M	€ 13,00	€ 15,45	312 60 021			3,0 m	SK	€ 48,00	€ 57,10	215 441 002 8	
		0,9 m	M	€ 11,70	€ 13,90	312 60 020			2,7 m	SK	€ 43,20	€ 51,40	215 441 002 5	
	F3	5,0 m	SK	€ 56,00	€ 66,65	215 60 037			1,0 m	SK	€ 16,20	€ 19,30	215 441 002 1	
		2,7 m	SK	€ 30,20	€ 35,95	215 60 035			0,9 m	SK	€ 15,10	€ 17,95	215 441 002 0	
		1,0 m	SK	€ 11,60	€ 13,80	215 60 031		F16 RAL9005	3,0 m	SK	€ 48,30	€ 57,50	215 441 701 8	
		0,9 m	SK	€ 10,60	€ 12,60	215 60 030			2,7 m	SK	€ 43,50	€ 51,75	215 441 701 5	
	F4	5,0 m	SK	€ 56,00	€ 66,65	215 60 047			1,0 m	SK	€ 16,30	€ 19,40	215 441 701 1	
		2,7 m	SK	€ 30,20	€ 35,95	215 60 045			0,9 m	SK	€ 15,20	€ 18,10	215 441 701 0	
		1,0 m	SK	€ 11,60	€ 13,80	215 60 041		H20	3,0 m	SK	€ 52,20	€ 62,10	215 441 120 8	
		0,9 m	SK	€ 10,60	€ 12,60	215 60 040		H22	3,0 m	SK	€ 52,20	€ 62,10	215 441 122 8	
	F5	5,0 m	SK	€ 59,50	€ 70,80	215 60 057		H30	3,0 m	SK	€ 52,20	€ 62,10	215 441 130 8	
		2,7 m	SK	€ 32,10	€ 38,20	215 60 055		H31	3,0 m	SK	€ 52,20	€ 62,10	215 441 131 8	
		1,0 m	SK	€ 12,40	€ 14,75	215 60 051		H33	3,0 m	SK	€ 52,20	€ 62,10	215 441 133 8	
		0,9 m	SK	€ 11,30	€ 13,45	215 60 050		H40	3,0 m	SK	€ 52,20	€ 62,10	215 441 140 8	
	F9	5,0 m	SK	€ 56,00	€ 66,65	215 60 097		H61	3,0 m	SK	€ 52,20	€ 62,10	215 441 161 8	
		2,7 m	SK	€ 30,20	€ 35,95	215 60 095		H62	3,0 m	SK	€ 52,20	€ 62,10	215 441 162 8	
		1,0 m	SK	€ 11,60	€ 13,80	215 60 091		H63	3,0 m	SK	€ 52,20	€ 62,10	215 441 163 8	
		0,9 m	SK	€ 10,60	€ 12,60	215 60 090		H64	3,0 m	SK	€ 52,20	€ 62,10	215 441 164 8	
	F6	5,0 m	SK	€ 59,50	€ 70,80	215 60 067		H80	3,0 m	SK	€ 52,20	€ 62,10	215 441 180 8	
		2,7 m	SK	€ 32,10	€ 38,20	215 60 065		H81	3,0 m	SK	€ 52,20	€ 62,10	215 441 181 8	
		1,0 m	SK	€ 12,40	€ 14,75	215 60 061		H95	3,0 m	SK	€ 52,20	€ 62,10	215 441 195 8	
		0,9 m	SK	€ 11,30	€ 13,45	215 60 060		462	F3	5,0 m	M	€ 65,50	€ 77,95	312 62 037
	F2G	5,0 m	SK	€ 67,00	€ 79,75	215 60 027			2,7 m	M	€ 35,60	€ 42,35	312 62 035	
		2,7 m	SK	€ 36,20	€ 43,10	215 60 025			1,0 m	M	€ 13,60	€ 16,20	312 62 031	
		1,0 m	SK	€ 13,80	€ 16,40	215 60 021			0,9 m	M	€ 12,60	€ 15,00	312 62 030	
		0,9 m	SK	€ 12,70	€ 15,10	215 60 020		F4	5,0 m	M	€ 65,50	€ 77,95	312 62 047	
461	F4	2,7 m	M	€ 49,70	€ 59,15	312 61 045			2,7 m	M	€ 35,60	€ 42,35	312 62 045	
	F9	2,7 m	M	€ 49,70	€ 59,15	312 61 095			1,0 m	M	€ 13,60	€ 16,20	312 62 041	
	F2G	2,7 m	M	€ 60,20	€ 71,65	312 61 025			0,9 m	M	€ 12,60	€ 15,00	312 62 040	
441	F3	5,0 m	M	€ 62,50	€ 74,40	312 441 003 7		F5	5,0 m	M	€ 71,50	€ 85,10	312 62 057	
		3,0 m	M	€ 37,50	€ 44,65	312 441 003 8			2,7 m	M	€ 38,60	€ 45,95	312 62 055	
		2,7 m	M	€ 33,80	€ 40,20	312 441 003 5			1,0 m	M	€ 14,70	€ 17,50	312 62 051	
		1,0 m	M	€ 12,70	€ 15,10	312 441 003 1			0,9 m	M	€ 13,40	€ 15,95	312 62 050	
		0,9 m	M	€ 11,70	€ 13,90	312 441 003 0		F9	5,0 m	M	€ 65,50	€ 77,95	312 62 097	
	F4	5,0 m	M	€ 62,50	€ 74,40	312 441 004 7			2,7 m	M	€ 35,60	€ 42,35	312 62 095	
		3,0 m	M	€ 37,50	€ 44,65	312 441 004 8			1,0 m	M	€ 13,60	€ 16,20	312 62 091	
		2,7 m	M	€ 33,80	€ 40,20	312 441 004 5			0,9 m	M	€ 12,60	€ 15,00	312 62 090	
		1,0 m	M	€ 12,70	€ 15,10	312 441 004 1		F6	5,0 m	M	€ 71,50	€ 85,10	312 62 067	
		0,9 m	M	€ 11,70	€ 13,90	312 441 004 0			2,7 m	M	€ 38,60	€ 45,95	312 62 065	
	F5	5,0 m	M	€ 67,50	€ 80,35	312 441 005 7			1,0 m	M	€ 14,70	€ 17,50	312 62 061	
		3,0 m	M	€ 40,50	€ 48,20	312 441 005 8			0,9 m	M	€ 13,40	€ 15,95	312 62 060	
		2,7 m	M	€ 36,50	€ 43,45	312 441 005 5		F2G	5,0 m	M	€ 81,00	€ 96,40	312 62 027	
		1,0 m	M	€ 13,70	€ 16,30	312 441 005 1			2,7 m	M	€ 43,70	€ 52,00	312 62 025	
		0,9 m	M	€ 12,70	€ 15,10	312 441 005 0			1,0 m	M	€ 16,60	€ 19,75	312 62 021	
	F9	5,0 m	M	€ 62,50	€ 74,40	312 441 009 7			0,9 m	M	€ 15,10	€ 17,95	312 62 020	
		3,0 m	M	€ 37,50	€ 44,65	312 441 009 8		F3	5,0 m	SK	€ 70,50	€ 83,90	215 62 037	

Übergangsprofile / Connecting Profiles

Artikel	Farben	Länge	Version	Preis/Stück	unit price	Bestell-Nr.
article	colour	length	version	exkl. MwSt.	inkl. MwSt.	order no.
		2,7 m	SK	€ 38,10	€ 45,35	215 62 045
		1,0 m	SK	€ 14,20	€ 16,90	215 62 041
		0,9 m	SK	€ 13,20	€ 15,70	215 62 040
F5		5,0 m	SK	€ 77,50	€ 92,25	215 62 057
		2,7 m	SK	€ 41,90	€ 49,85	215 62 055
		1,0 m	SK	€ 15,60	€ 18,55	215 62 051
		0,9 m	SK	€ 14,30	€ 17,00	215 62 050
F9		5,0 m	SK	€ 70,50	€ 83,90	215 62 097
		2,7 m	SK	€ 38,10	€ 45,35	215 62 095
		1,0 m	SK	€ 14,20	€ 16,90	215 62 091
		0,9 m	SK	€ 13,20	€ 15,70	215 62 090
F6		5,0 m	SK	€ 77,50	€ 92,25	215 62 067
		2,7 m	SK	€ 41,90	€ 49,85	215 62 065
		1,0 m	SK	€ 15,60	€ 18,55	215 62 061
		0,9 m	SK	€ 14,30	€ 17,00	215 62 060
F2G		5,0 m	SK	€ 85,50	€ 101,75	215 62 027
		2,7 m	SK	€ 46,20	€ 55,00	215 62 025
		1,0 m	SK	€ 17,20	€ 20,45	215 62 021
		0,9 m	SK	€ 15,80	€ 18,80	215 62 020
F15 RAL9016		5,0 m	SK	€ 86,00	€ 102,35	215 462 715 7
		2,7 m	SK	€ 46,40	€ 55,20	215 462 715 5
		1,0 m	SK	€ 17,30	€ 20,60	215 462 715 1
		0,9 m	SK	€ 15,90	€ 18,90	215 462 715 0
F16 RAL9005		5,0 m	SK	€ 86,00	€ 102,35	215 462 701 7
		2,7 m	SK	€ 46,40	€ 55,20	215 462 701 5
		1,0 m	SK	€ 17,30	€ 20,60	215 462 701 1
		0,9 m	SK	€ 15,90	€ 18,90	215 462 701 0
H20		2,7 m	SK	€ 46,40	€ 55,20	215 62 205
		0,9 m	SK	€ 15,80	€ 18,80	215 62 200
H22		2,7 m	SK	€ 46,40	€ 55,20	215 62 225
		0,9 m	SK	€ 15,80	€ 18,80	215 62 220
H30		2,7 m	SK	€ 46,40	€ 55,20	215 62 305
		0,9 m	SK	€ 15,80	€ 18,80	215 62 300
H31		2,7 m	SK	€ 46,40	€ 55,20	215 62 315
		0,9 m	SK	€ 15,80	€ 18,80	215 62 310
H33		2,7 m	SK	€ 46,40	€ 55,20	215 62 335
		0,9 m	SK	€ 15,80	€ 18,80	215 62 330
H40		2,7 m	SK	€ 46,40	€ 55,20	215 62 405
		0,9 m	SK	€ 15,80	€ 18,80	215 62 400
H61		2,7 m	SK	€ 46,40	€ 55,20	215 62 615
		0,9 m	SK	€ 15,80	€ 18,80	215 62 610
H62		2,7 m	SK	€ 46,40	€ 55,20	215 62 625
		0,9 m	SK	€ 15,80	€ 18,80	215 62 620
H63		2,7 m	SK	€ 46,40	€ 55,20	215 62 635
		0,9 m	SK	€ 15,80	€ 18,80	215 62 630
H64		2,7 m	SK	€ 46,40	€ 55,20	215 62 645
		0,9 m	SK	€ 15,80	€ 18,80	215 62 640
H65		2,7 m	SK	€ 46,40	€ 55,20	215 62 655
		0,9 m	SK	€ 15,80	€ 18,80	215 62 650
H80		2,7 m	SK	€ 46,40	€ 55,20	215 62 805
		0,9 m	SK	€ 15,80	€ 18,80	215 62 800
H81		2,7 m	SK	€ 46,40	€ 55,20	215 62 835
		0,9 m	SK	€ 15,80	€ 18,80	215 62 830
H95		2,7 m	SK	€ 46,40	€ 55,20	215 62 955
		0,9 m	SK	€ 15,80	€ 18,80	215 62 950
463		5,0 m	M	€ 77,00	€ 91,65	312 63 037
		2,7 m	M	€ 41,60	€ 49,50	312 63 035
F4		5,0 m	M	€ 77,00	€ 91,65	312 63 047
		2,7 m	M	€ 41,60	€ 49,50	312 63 045
		1,0 m	M	€ 15,80	€ 18,80	312 63 041
		0,9 m	M	€ 14,50	€ 17,25	312 63 040
F5		5,0 m	M	€ 83,00	€ 98,75	312 63 057
		2,7 m	M	€ 44,80	€ 53,30	312 63 055
		1,0 m	M	€ 17,00	€ 20,25	312 63 051
		0,9 m	M	€ 15,70	€ 18,70	312 63 050
F9		5,0 m	M	€ 77,00	€ 91,65	312 63 097
		2,7 m	M	€ 41,60	€ 49,50	312 63 095
		1,0 m	M	€ 15,80	€ 18,80	312 63 091
		0,9 m	M	€ 14,50	€ 17,25	312 63 090
F6		5,0 m	M	€ 83,00	€ 98,75	312 63 067
		2,7 m	M	€ 44,80	€ 53,30	312 63 065
		1,0 m	M	€ 17,00	€ 20,25	312 63 061
		0,9 m	M	€ 15,70	€ 18,70	312 63 060
F2G		5,0 m	M	€ 94,00	€ 111,85	312 63 027
		2,7 m	M	€ 50,80	€ 60,45	312 63 025
		1,0 m	M	€ 19,20	€ 22,85	312 63 021
		0,9 m	M	€ 17,40	€ 20,70	312 63 020
F3		5,0 m	SK	€ 82,50	€ 98,20	215 63 037
		2,7 m	SK	€ 45,10	€ 53,65	215 63 035
F4		5,0 m	SK	€ 83,00	€ 98,75	215 63 047
		2,7 m	SK	€ 44,80	€ 53,30	215 63 045
		1,0 m	SK	€ 16,70	€ 19,85	215 63 041
		0,9 m	SK	€ 15,20	€ 18,10	215 63 040
F5		5,0 m	SK	€ 88,50	€ 105,30	215 63 057
		2,7 m	SK	€ 47,80	€ 56,90	215 63 055

Artikel	Farben	Länge	Version	Preis/Stück	unit price	Bestell-Nr.
article	colour	length	version	exkl. MwSt.	inkl. MwSt.	order no.
		1,0 m	SK	€ 17,80	€ 21,20	215 63 051
		0,9 m	SK	€ 16,40	€ 19,50	215 63 050
F9		5,0 m	SK	€ 83,00	€ 98,75	215 63 097
		2,7 m	SK	€ 44,80	€ 53,30	215 63 095
		1,0 m	SK	€ 16,70	€ 19,85	215 63 091
		0,9 m	SK	€ 15,20	€ 18,10	215 63 090
F6		5,0 m	SK	€ 88,50	€ 105,30	215 63 067
		2,7 m	SK	€ 47,80	€ 56,90	215 63 065
		1,0 m	SK	€ 17,80	€ 21,20	215 63 061
		0,9 m	SK	€ 16,40	€ 19,50	215 63 060
F2G		5,0 m	SK	€ 100,00	€ 119,00	215 63 027
		2,7 m	SK	€ 54,00	€ 64,25	215 63 025
		1,0 m	SK	€ 20,10	€ 23,90	215 63 021
		0,9 m	SK	€ 18,30	€ 21,80	215 63 020
F4		5,0 m	S	€ 83,00	€ 98,75	313 63 047
		2,7 m	S	€ 44,80	€ 53,30	313 63 045
		1,0 m	S	€ 16,80	€ 20,00	313 63 041
F5		5,0 m	S	€ 84,50	€ 100,55	313 63 057
		2,7 m	S	€ 45,60	€ 54,25	313 63 055
		1,0 m	S	€ 17,10	€ 20,35	313 63 051
464		5,0 m	M	€ 90,00	€ 107,10	312 64 047
		2,7 m	M	€ 48,60	€ 57,85	312 64 045
		1,0 m	M	€ 18,20	€ 21,65	312 64 041
		0,9 m	M	€ 16,60	€ 19,75	312 64 040
F5		5,0 m	M	€ 94,00	€ 111,85	312 64 057
		2,7 m	M	€ 50,80	€ 60,45	312 64 055
		1,0 m	M	€ 19,00	€ 22,60	312 64 051
		0,9 m	M	€ 17,50	€ 20,85	312 64 050
F9		5,0 m	M	€ 90,00	€ 107,10	312 64 097
		2,7 m	M	€ 48,60	€ 57,85	312 64 095
		1,0 m	M	€ 18,20	€ 21,65	312 64 091
		0,9 m	M	€ 16,60	€ 19,75	312 64 090
F6		5,0 m	M	€ 94,00	€ 111,85	312 64 067
		2,7 m	M	€ 50,80	€ 60,45	312 64 065
		1,0 m	M	€ 19,00	€ 22,60	312 64 061
		0,9 m	M	€ 17,50	€ 20,85	312 64 060
F2G		5,0 m	M	€ 107,00	€ 127,35	312 64 027
		2,7 m	M	€ 57,80	€ 68,80	312 64 025
		1,0 m	M	€ 21,70	€ 25,80	312 64 021
		0,9 m	M	€ 19,60	€ 23,30	312 64 020
F3		5,0 m	SK	€ 94,50	€ 112,45	215 64 037
		2,7 m	SK	€ 51,00	€ 60,70	215 64 035
F4		5,0 m	SK	€ 94,50	€ 112,45	215 64 047
		2,7 m	SK	€ 51,00	€ 60,70	215 64 045
		1,0 m	SK	€ 19,10	€ 22,75	215 64 041
		0,9 m	SK	€ 17,60	€ 20,95	215 64 040
F5		5,0 m	SK	€ 100,50	€ 119,60	215 64 057
		2,7 m	SK	€ 54,30	€ 64,60	215 64 055
		1,0 m	SK	€ 20,20	€ 24,05	215 64 051
		0,9 m	SK	€ 18,40	€ 21,90	215 64 050
F9		5,0 m	SK	€ 94,50	€ 112,45	215 64 097
		2,7 m	SK	€ 51,00	€ 60,70	215 64 095
		1,0 m	SK	€ 19,10	€ 22,75	215 64 091
		0,9 m	SK	€ 17,60	€ 20,95	215 64 090
F6		5,0 m	SK	€ 100,50	€ 119,60	215 64 067
		2,7 m	SK	€ 54,30	€ 64,60	215 64 065
		1,0 m	SK	€ 20,20	€ 24,05	215 64 061
		0,9 m	SK	€ 18,40	€ 21,90	215 64 060
F2G		5,0 m	SK	€ 113,00	€ 134,45	215 64 027
		2,7 m	SK	€ 61,00	€ 72,60	215 64 025
		1,0 m	SK	€ 22,80	€ 27,15	215 64 021
		0,9 m	SK	€ 20,80	€ 24,75	215 64 020
F4		5,0 m	S	€ 95,00	€ 113,05	313 64 047
		2,7 m	S	€ 51,30	€ 61,05	313 64 045
		1,0 m	S	€ 19,20	€ 22,85	313 64 041
F5		5,0 m	S	€ 97,00	€ 115,45	313 64 057
		2,7 m	S	€ 52,40	€ 62,35	313 64 055
		1,0 m	S	€ 19,60	€ 23,30	313 64 051
444		5,0 m	S	€ 135,00	€ 160,65	313 44 037
		2,7 m	S	€ 72,90	€ 86,75	313 44 035
F4		5,0 m	S	€ 135,00	€ 160,65	313 44

Artikel article	Farben colour	Länge length	Version version	Preis/Stück unit price		Bestell-Nr. order no.
				exkl. MwSt. incl. VAT	inkl. MwSt. incl. VAT	
F2G	0,9 m S	€ 27,00	€ 32,15	313 44 060		
		5,0 m S	€ 159,00	€ 189,20	313 44 027	
		2,7 m S	€ 85,90	€ 102,20	313 44 025	
	1,0 m S	€ 32,00	€ 38,10	313 44 021		
		0,9 m S	€ 29,30	€ 34,85	313 44 020	
		5,0 m SK	€ 146,50	€ 174,35	215 444 003 7	
	F3	2,7 m SK	€ 79,10	€ 94,15	215 444 003 5	
		5,0 m SK	€ 146,50	€ 174,35	215 444 004 7	
		2,7 m SK	€ 79,10	€ 94,15	215 444 004 5	
	F4	1,0 m SK	€ 29,50	€ 35,10	215 444 004 1	
		0,9 m SK	€ 26,90	€ 32,00	215 444 004 0	
		5,0 m SK	€ 158,00	€ 188,00	215 444 005 7	
F5	2,7 m SK	€ 85,30	€ 101,50	215 444 005 5		
	1,0 m SK	€ 31,80	€ 37,85	215 444 005 1		
	0,9 m SK	€ 29,10	€ 34,65	215 444 005 0		
F9	5,0 m SK	€ 146,50	€ 174,35	215 444 009 7		
	2,7 m SK	€ 79,10	€ 94,15	215 444 009 5		
	1,0 m SK	€ 29,50	€ 35,10	215 444 009 1		
F6	0,9 m SK	€ 26,90	€ 32,00	215 444 009 0		
	5,0 m SK	€ 158,00	€ 188,00	215 444 006 7		
	2,7 m SK	€ 85,30	€ 101,50	215 444 006 5		
F2G	1,0 m SK	€ 31,80	€ 37,85	215 444 006 1		
	0,9 m SK	€ 29,10	€ 34,65	215 444 006 0		
	5,0 m SK	€ 169,50	€ 201,70	215 444 002 7		
F16 RAL9005	2,7 m SK	€ 91,50	€ 108,90	215 444 002 5		
	1,0 m SK	€ 34,00	€ 40,45	215 444 002 1		
	0,9 m SK	€ 31,10	€ 37,00	215 444 002 0		
465 F4	3,0 m SK	€ 104,70	€ 124,60	215 444 701 8		
	2,7 m SK	€ 94,20	€ 112,10	215 444 701 5		
	1,0 m SK	€ 35,10	€ 41,75	215 444 701 1		
465 F4	0,9 m SK	€ 32,00	€ 38,10	215 444 701 0		
	5,0 m M	€ 120,00	€ 142,80	312 65 047		
	2,7 m M	€ 64,80	€ 77,10	312 65 045		
465 F5	1,0 m M	€ 24,30	€ 28,90	312 65 041		
	5,0 m M	€ 129,50	€ 154,10	312 65 057		
	2,7 m M	€ 69,90	€ 83,20	312 65 055		
465 F9	1,0 m M	€ 26,10	€ 31,05	312 65 051		
	5,0 m M	€ 120,00	€ 142,80	312 65 097		
	2,7 m M	€ 64,80	€ 77,10	312 65 095		
465 F6	1,0 m M	€ 24,30	€ 28,90	312 65 091		
	5,0 m M	€ 129,50	€ 154,10	312 65 067		
	2,7 m M	€ 69,90	€ 83,20	312 65 065		
465 F2G	1,0 m M	€ 26,10	€ 31,05	312 65 061		
	5,0 m M	€ 142,00	€ 169,00	312 65 027		
	2,7 m M	€ 76,70	€ 91,25	312 65 025		
465 F3	1,0 m M	€ 28,50	€ 33,90	312 65 021		
	5,0 m U	€ 112,50	€ 133,90	211 65 037		
	2,7 m U	€ 60,80	€ 72,35	211 65 035		
465 F4	5,0 m U	€ 112,50	€ 133,90	211 65 047		
	2,7 m U	€ 60,80	€ 72,35	211 65 045		
	1,0 m U	€ 22,70	€ 27,00	211 65 041		
465 F5	5,0 m U	€ 121,50	€ 144,60	211 65 057		
	2,7 m U	€ 65,60	€ 78,05	211 65 055		
	1,0 m U	€ 24,50	€ 29,15	211 65 051		
465 F9	5,0 m U	€ 112,50	€ 133,90	211 65 097		
	2,7 m U	€ 60,80	€ 72,35	211 65 095		
	1,0 m U	€ 22,70	€ 27,00	211 65 091		
465 F6	5,0 m U	€ 121,50	€ 144,60	211 65 067		
	2,7 m U	€ 65,60	€ 78,05	211 65 065		
	1,0 m U	€ 24,50	€ 29,15	211 65 061		
465 F2G	5,0 m U	€ 133,00	€ 158,25	211 65 027		
	2,7 m U	€ 71,80	€ 85,45	211 65 025		
	1,0 m U	€ 26,90	€ 32,00	211 65 021		
465 F4	5,0 m S	€ 127,00	€ 151,15	313 65 047		
	2,7 m S	€ 68,60	€ 81,65	313 65 045		
	1,0 m S	€ 25,60	€ 30,45	313 65 041		
465 F5	5,0 m S	€ 130,00	€ 154,70	313 65 057		
	2,7 m S	€ 70,20	€ 83,55	313 65 055		
	1,0 m S	€ 26,20	€ 31,20	313 65 051		
466 F4	5,0 m M	€ 148,00	€ 176,10	312 66 047		
	2,7 m M	€ 79,90	€ 95,10	312 66 045		
	1,0 m M	€ 29,80	€ 35,45	312 66 041		
466 F5	5,0 m M	€ 158,50	€ 188,60	312 66 057		
	2,7 m M	€ 85,60	€ 101,85	312 66 055		
	1,0 m M	€ 31,90	€ 37,95	312 66 051		
466 F9	5,0 m M	€ 148,00	€ 176,10	312 66 097		
	2,7 m M	€ 79,90	€ 95,10	312 66 095		
	1,0 m M	€ 29,80	€ 35,45	312 66 091		
466 F6	5,0 m M	€ 158,50	€ 188,60	312 66 067		
	2,7 m M	€ 85,60	€ 101,85	312 66 065		
	1,0 m M	€ 31,90	€ 37,95	312 66 061		
466 F2G	5,0 m M	€ 174,00	€ 207,05	312 66 027		
	2,7 m M	€ 94,00	€ 111,85	312 66 025		
	1,0 m M	€ 35,00	€ 41,65	312 66 021		
466 F3	5,0 m U	€ 138,00	€ 164,20	211 66 037		

Artikel article	Farben colour	Länge length	Version version	Preis/Stück unit price		Bestell-Nr. order no.
				exkl. MwSt. incl. VAT	inkl. MwSt. incl. VAT	
F4	0,9 m U	€ 74,50	€ 88,65	211 66 035		
		5,0 m U	€ 138,00	€ 164,20	211 66 047	
		2,7 m U	€ 74,50	€ 88,65	211 66 045	
F5	1,0 m U	€ 27,80	€ 33,10	211 66 041		
		5,0 m U	€ 149,00	€ 177,30	211 66 057	
		2,7 m U	€ 80,50	€ 95,80	211 66 055	
F9	1,0 m U	€ 30,00	€ 35,70	211 66 051		
		5,0 m U	€ 138,00	€ 164,20	211 66 097	
		2,7 m U	€ 74,50	€ 88,65	211 66 095	
F6	1,0 m U	€ 27,80	€ 33,10	211 66 091		
		5,0 m U	€ 149,00	€ 177,30	211 66 067	
		2,7 m U	€ 80,50	€ 95,80	211 66 065	
F2G	1,0 m U	€ 30,00	€ 35,70	211 66 061		
		5,0 m U	€ 164,50	€ 195,75	211 66 027	
		2,7 m U	€ 88,80	€ 105,65	211 66 025	
F4	1,0 m U	€ 33,10	€ 39,40	211 66 021		
		5,0 m S	€ 153,50	€ 182,65	313 66 047	
		2,7 m S	€ 82,60	€ 98,30	313 66 045	
F5	1,0 m S	€ 30,80	€ 36,65	313 66 041		
		5,0 m S	€ 157,00	€ 186,85	313 66 057	
		2,7 m S	€ 84,50	€ 100,55	313 66 055	
F5	1,0 m S	€ 31,60	€ 37,60	313 66 051		

Übergangsp. Alu u. Messing m. Zierrillen
Connecting Profiles Alu and Brass, fluted

230 F4	5,0 m M	€ 43,00	€ 51,15	312 30 047	
		2,7 m M	€ 23,20	€ 27,60	312 30 045
		1,0 m M	€ 9,00	€ 10,70	312 30 041
230 F5	0,9 m M	€ 8,10	€ 9,65	312 30 040	
		5,0 m M	€ 47,00	€ 55,95	312 30 057
		2,7 m M	€ 25,40	€ 30,25	312 30 055
230 F9	1,0 m M	€ 10,10	€ 12,00	312 30 051	
		0,9 m M	€ 9,20	€ 10,95	312 30 050
		5,0 m M	€ 43,00	€ 51,15	312 30 097
230 F6	2,7 m M	€ 23,20	€ 27,60	312 30 095	
		1,0 m M	€ 9,00	€ 10,70	312 30 091
		0,9 m M	€ 8,10	€ 9,65	312 30 090
230 F6	5,0 m M	€ 47,00	€ 55,95	312 30 067	
		2,7 m M	€ 25,40	€ 30,25	312 30 065
		1,0 m M	€ 10,00	€ 11,90	312 30 061
230 F2	0,9 m M	€ 9,20	€ 10,95	312 30 060	
		5,0 m M	€ 47,00	€ 55,95	312 30 027
		2,7 m M	€ 25,40	€ 30,25	312 30 025
230 F4	1,0 m M	€ 10,00	€ 11,90	312 30 021	
		0,9 m M	€ 9,20	€ 10,95	312 30 020
		5,0 m SK	€ 46,50	€ 55,35	215 30 047
230 F4	2,7 m SK	€ 25,10	€ 29,85	215 30 045	
		1,0 m SK	€ 10,00	€ 11,90	215 30 041
		0,9 m SK	€ 9,00	€ 10,70	215 30 040
230 F5	5,0 m SK	€ 51,00	€ 60,70	215 30 057	
		2,7 m SK	€ 27,50	€ 32,75	215 30 055
		1,0 m SK	€ 11,00	€ 13,10	215 30 051
230 F9	0,9 m SK	€ 10,00	€ 11,90	215 30 050	
		5,0 m SK	€ 46,50	€ 55,35	215 30 097
		2,7 m SK	€ 25,10	€ 29,85	215 30 095
230 F6	1,0 m SK	€ 10,00	€ 11,90	215 30 091	
		0,9 m SK	€ 9,00	€ 10,70	215 30 090
		5,0 m SK	€ 51,00	€ 60,70	215 30 067
230 F2	2,7 m SK	€ 27,50	€ 32,75	215 30 065	
		1,0 m SK	€ 11,00	€ 13,10	215 30 061
		0,9 m SK	€ 10,00	€ 11,90	215 30 060
230 F2	5,0 m SK	€ 51,00	€ 60,70	215 30 027	
		2,7 m SK	€ 27,50	€ 32,75	215 30 025
		1,0 m SK	€ 11,00	€ 13,10	215 30 021
230 F4	0,9 m SK	€ 10,00	€ 11,90	215 30 020	
		5,0 m SK	€ 46,50	€ 55,35	215 30 047
		2,7 m SK	€ 25,10	€ 29,85	215 30 045
230 F5	1,0 m SK	€ 10,00	€ 11,90	215 30 041	
		0,9 m SK	€ 9,00	€ 10,70	215 30 040
		5,0 m SK	€ 51,00	€ 60,70	215 30 057
230 F9	2,7 m SK	€ 27,50	€ 32,75	215 30 055	
		1,0 m SK	€ 11,00	€ 13,10	215 30 051
		0,9 m SK	€ 10,00	€ 11,90	215 30 050
230 F6	5,0 m SK	€ 46,50	€ 55,35	215 30 097	
		2,7 m SK	€ 25,10	€ 29,85	215 30 095
		1,0 m SK	€ 10,00	€ 11,90	215 30 091
230 F6	0,9 m SK	€ 9,00	€ 10,70	215 30 090	
		5,0 m SK	€ 51,00	€ 60,70	215 30 067
		2,7 m SK	€ 27,50	€ 32,75	215 30 065
230 F4	1,0 m SK	€ 11,00	€ 13,10	215 30 061	
		0,9 m SK	€ 10,00	€ 11,90	215 30 060
		5,0 m SK	€ 51,00	€ 60,70	215 30 027
230 F2	2,7 m SK	€ 27,50	€ 32,75	215 30 025	
		1,0 m SK	€ 11,00	€ 13,10	215 30 021
		0,9 m SK	€ 10,00	€ 11,90	215 30 020
230 F16 RAL9005	5,0 m SK	€ 30,00	€ 35,70	215 230 701 5	
		2,7 m SK	€ 16,90	€ 19,95	215 230 701 0
		0,9 m SK	€ 10,90	€ 12,95	215 230 701 0
439 F3	5,0 m M	€ 43,50	€ 51,75	312 39 037	
		2,7 m M	€ 23,50	€ 27,95	312 39 035
		1,0 m M	€ 9,20	€ 10,95	312 39 031
439 F4	0,9 m M	€ 8,30	€ 9,90	312 39 030	
		5,0 m M	€ 43,50	€ 51,75	312 39 047
		2,7 m M	€ 23,50	€ 27,95	312 39 045
439 F5	1,0 m M	€ 9,20	€ 10,95	312 39 041	
		0,9 m M	€ 8,30	€ 9,90	312 39 040
		5,0 m M	€ 47,50	€ 56,55	312 39 057
439 F5	2,7 m M	€ 25,70	€ 30,60	312 39 055	
		1,0 m M	€ 10,20	€ 12,15	312 39 051
		0,9 m M	€ 9,50	€ 11,30	312 39 050
439 F9	5,0 m M	€ 43,50	€ 51,75	312 39 097	
		2,7 m M	€ 23,50	€ 27,95	312 39 095
		1,0 m M	€ 9,20	€ 10,95	312 39 091

Übergangsprofile / Connecting Profiles

Artikel	Farben	Länge	Version	Preis/Stück	unit price	Bestell-Nr.
article	colour	length	version	exkl. MwSt.	inkl. MwSt.	order no.
		0,9 m	M	€ 8,30	€ 9,90	312 39 090
F6		5,0 m	M	€ 47,50	€ 56,55	312 39 067
		2,7 m	M	€ 25,70	€ 30,60	312 39 065
		1,0 m	M	€ 10,20	€ 12,15	312 39 061
		0,9 m	M	€ 9,50	€ 11,30	312 39 060
F2		5,0 m	M	€ 47,50	€ 56,55	312 39 027
		2,7 m	M	€ 25,70	€ 30,60	312 39 025
		1,0 m	M	€ 10,20	€ 12,15	312 39 021
		0,9 m	M	€ 9,50	€ 11,30	312 39 020
F3		5,0 m	SK	€ 47,00	€ 55,95	215 39 037
		2,7 m	SK	€ 25,40	€ 30,25	215 39 035
		0,9 m	SK	€ 9,20	€ 10,95	215 39 030
F4		5,0 m	SK	€ 47,00	€ 55,95	215 39 047
		2,7 m	SK	€ 25,40	€ 30,25	215 39 045
		0,9 m	SK	€ 9,20	€ 10,95	215 39 040
F5		5,0 m	SK	€ 53,00	€ 63,05	215 39 057
		2,7 m	SK	€ 28,90	€ 34,40	215 39 055
		0,9 m	SK	€ 10,10	€ 12,00	215 39 050
F9		5,0 m	SK	€ 47,00	€ 55,95	215 39 097
		2,7 m	SK	€ 25,40	€ 30,25	215 39 095
		0,9 m	SK	€ 9,20	€ 10,95	215 39 090
F6		5,0 m	SK	€ 53,00	€ 63,05	215 39 067
		2,7 m	SK	€ 28,90	€ 34,40	215 39 065
		0,9 m	SK	€ 10,10	€ 12,00	215 39 060
F2		5,0 m	SK	€ 53,00	€ 63,05	215 39 027
		2,7 m	SK	€ 28,90	€ 34,40	215 39 025
		0,9 m	SK	€ 10,10	€ 12,00	215 39 020
H20		2,7 m	SK	€ 32,90	€ 39,15	215 39 205
		0,9 m	SK	€ 11,60	€ 13,80	215 39 200
H22		2,7 m	SK	€ 32,90	€ 39,15	215 39 225
		0,9 m	SK	€ 11,60	€ 13,80	215 39 220
H30		2,7 m	SK	€ 32,90	€ 39,15	215 39 305
		0,9 m	SK	€ 11,60	€ 13,80	215 39 300
H31		2,7 m	SK	€ 32,90	€ 39,15	215 39 315
		0,9 m	SK	€ 11,60	€ 13,80	215 39 310
H33		2,7 m	SK	€ 32,90	€ 39,15	215 39 335
		0,9 m	SK	€ 11,60	€ 13,80	215 39 330
H40		2,7 m	SK	€ 32,90	€ 39,15	215 39 405
		0,9 m	SK	€ 11,60	€ 13,80	215 39 400
H61		2,7 m	SK	€ 32,90	€ 39,15	215 39 615
		0,9 m	SK	€ 11,60	€ 13,80	215 39 610
H62		2,7 m	SK	€ 32,90	€ 39,15	215 39 625
		0,9 m	SK	€ 11,60	€ 13,80	215 39 620
H63		2,7 m	SK	€ 32,90	€ 39,15	215 39 635
		0,9 m	SK	€ 11,60	€ 13,80	215 39 630
H64		2,7 m	SK	€ 32,90	€ 39,15	215 39 645
		0,9 m	SK	€ 11,60	€ 13,80	215 39 640
H80		2,7 m	SK	€ 32,90	€ 39,15	215 39 805
		0,9 m	SK	€ 11,60	€ 13,80	215 39 800
H81		2,7 m	SK	€ 32,90	€ 39,15	215 39 835
		0,9 m	SK	€ 11,60	€ 13,80	215 39 830
H95		2,7 m	SK	€ 32,90	€ 39,15	215 39 955
		0,9 m	SK	€ 11,60	€ 13,80	215 39 950
440		5,0 m	M	€ 59,00	€ 70,20	312 40 047
		2,7 m	M	€ 31,90	€ 37,95	312 40 045
		1,0 m	M	€ 12,00	€ 14,30	312 40 041
		0,9 m	M	€ 11,20	€ 13,35	312 40 040
F5		2,7 m	M	€ 35,40	€ 42,15	312 40 055
		1,0 m	M	€ 13,30	€ 15,85	312 40 051
		0,9 m	M	€ 12,10	€ 14,40	312 40 050
F9		2,7 m	M	€ 31,90	€ 37,95	312 40 095
		1,0 m	M	€ 12,00	€ 14,30	312 40 091
		0,9 m	M	€ 11,20	€ 13,35	312 40 090
F6		2,7 m	M	€ 35,40	€ 42,15	312 40 065
		1,0 m	M	€ 13,30	€ 15,85	312 40 061
		0,9 m	M	€ 12,10	€ 14,40	312 40 060
F2		5,0 m	M	€ 65,50	€ 77,95	312 40 027
		2,7 m	M	€ 35,40	€ 42,15	312 40 025
		1,0 m	M	€ 13,30	€ 15,85	312 40 021
		0,9 m	M	€ 12,10	€ 14,40	312 40 020
F4		5,0 m	SK	€ 65,00	€ 77,35	215 440 004 7
		2,7 m	SK	€ 35,10	€ 41,75	215 440 004 5
		1,0 m	SK	€ 13,30	€ 15,85	215 440 004 1
		0,9 m	SK	€ 12,40	€ 14,75	215 440 004 0
F5		2,7 m	SK	€ 38,30	€ 45,60	215 440 005 5
		1,0 m	SK	€ 14,40	€ 17,15	215 440 005 1
F9		2,7 m	SK	€ 35,10	€ 41,75	215 440 009 5
		1,0 m	SK	€ 13,30	€ 15,85	215 440 009 1
F6		2,7 m	SK	€ 38,30	€ 45,60	215 440 006 5
		1,0 m	SK	€ 14,40	€ 17,15	215 440 006 1
F2		5,0 m	SK	€ 71,00	€ 84,50	215 440 002 7
		2,7 m	SK	€ 38,30	€ 45,60	215 440 002 5
		1,0 m	SK	€ 14,40	€ 17,15	215 440 002 1
		0,9 m	SK	€ 13,40	€ 15,95	215 440 002 0
F16 RAL9005		5,0 m	SK	€ 77,50	€ 92,25	215 440 701 7

Artikel	Farben	Länge	Version	Preis/Stück	unit price	Bestell-Nr.
article	colour	length	version	exkl. MwSt.	inkl. MwSt.	order no.
		2,7 m	SK	€ 42,10	€ 50,10	215 440 701 5
445	F4	2,7 m	M	€ 32,90	€ 39,15	312 445 004 5
		0,9 m	M	€ 11,50	€ 13,70	312 445 004 0
	F9	2,7 m	M	€ 32,90	€ 39,15	312 445 009 5
	F2	2,7 m	M	€ 36,20	€ 43,10	312 445 002 5
		0,9 m	M	€ 12,40	€ 14,75	312 445 002 0
438	F3	5,0 m	M	€ 47,50	€ 56,55	312 38 037
		3,0 m	M	€ 28,50	€ 33,90	312 38 038
		2,7 m	M	€ 25,70	€ 30,60	312 38 035
		1,0 m	M	€ 10,10	€ 12,00	312 38 031
		0,9 m	M	€ 9,50	€ 11,30	312 38 030
	F4	5,0 m	M	€ 47,50	€ 56,55	312 38 047
		3,0 m	M	€ 28,50	€ 33,90	312 38 048
		2,7 m	M	€ 25,70	€ 30,60	312 38 045
		1,0 m	M	€ 10,10	€ 12,00	312 38 041
		0,9 m	M	€ 9,50	€ 11,30	312 38 040
	F4G	3,0 m	M	€ 39,30	€ 46,75	312 438 804 8
		1,0 m	M	€ 13,70	€ 16,30	312 438 804 1
	F5	5,0 m	M	€ 53,50	€ 63,65	312 38 057
		3,0 m	M	€ 32,10	€ 38,20	312 38 058
		2,7 m	M	€ 28,90	€ 34,40	312 38 055
		1,0 m	M	€ 11,30	€ 13,45	312 38 051
		0,9 m	M	€ 10,40	€ 12,40	312 38 050
	F9	5,0 m	M	€ 47,50	€ 56,55	312 38 097
		3,0 m	M	€ 28,50	€ 33,90	312 38 098
		2,7 m	M	€ 25,70	€ 30,60	312 38 095
		1,0 m	M	€ 10,10	€ 12,00	312 38 091
		0,9 m	M	€ 9,50	€ 11,30	312 38 090
	F6	5,0 m	M	€ 53,50	€ 63,65	312 38 067
		3,0 m	M	€ 32,10	€ 38,20	312 38 068
		2,7 m	M	€ 28,90	€ 34,40	312 38 065
		1,0 m	M	€ 11,30	€ 13,45	312 38 061
		0,9 m	M	€ 10,40	€ 12,40	312 38 060
	F2	5,0 m	M	€ 53,50	€ 63,65	312 38 027
		3,0 m	M	€ 32,10	€ 38,20	312 38 028
		2,7 m	M	€ 28,90	€ 34,40	312 38 025
		1,0 m	M	€ 11,30	€ 13,45	312 38 021
		0,9 m	M	€ 10,40	€ 12,40	312 38 020
	F1G	3,0 m	M	€ 42,00	€ 50,00	312 438 801 8
		1,0 m	M	€ 14,60	€ 17,35	312 438 801 1
	F3	5,0 m	SK	€ 53,50	€ 63,65	215 38 037
		3,0 m	SK	€ 32,10	€ 38,20	215 38 038
		2,7 m	SK	€ 28,90	€ 34,40	215 38 035
		1,0 m	SK	€ 11,10	€ 13,20	215 38 031
		0,9 m	SK	€ 10,10	€ 12,00	215 38 030
	F4	5,0 m	SK	€ 53,50	€ 63,65	215 38 047
		3,0 m	SK	€ 32,10	€ 38,20	215 38 048
		2,7 m	SK	€ 28,90	€ 34,40	215 38 045
		1,0 m	SK	€ 11,10	€ 13,20	215 38 041
		0,9 m	SK	€ 10,10	€ 12,00	215 38 040
	F4G	3,0 m	SK	€ 42,00	€ 50,00	215 438 804 8
		1,0 m	SK	€ 14,60	€ 17,35	215 438 804 1
	F5	5,0 m	SK	€ 58,00	€ 69,00	215 38 057
		3,0 m	SK	€ 34,80	€ 41,40	215 38 058
		2,7 m	SK	€ 31,30	€ 37,25	215 38 055
		1,0 m	SK	€ 12,10	€ 14,40	215 38 051
		0,9 m	SK	€ 11,10	€ 13,20	215 38 050
	F9	5,0 m	SK	€ 53,50	€ 63,65	215 38 097
		3,0 m	SK	€ 32,10	€ 38,20	215 38 098
		2,7 m	SK	€ 28,90	€ 34,40	215 38 095
		1,0 m	SK	€ 11,10	€ 13,20	215 38 091
		0,9 m	SK	€ 10,10	€ 12,00	215 38 090
	F6	5,0 m	SK	€ 58,00	€ 69,00	215 38 067
		3,0 m	SK	€ 34,80	€ 41,40	215 38 068
		2,7 m	SK	€ 31,30	€ 37,25	215 38 065
		1,0 m	SK	€ 12,10	€ 14,40	215 38 061
		0,9 m	SK	€ 11,10	€ 13,20	215 38 060
	F2	5,0 m	SK	€ 58,00	€ 69,00	215 38 027
		3,0 m	SK	€ 34,80	€ 41,40	215 38 028
		2,7 m	SK	€ 31,30	€ 37,25	215 38 025
		1,0 m	SK	€ 12,10	€ 14,40	2

Artikel	Farben	Länge	Version	Preis/Stück		Bestell-Nr.
				exkl. MwSt.	inkl. MwSt.	
article	colour	length	version	excl. VAT	incl. VAT	order no.
		0,9 m	SK	€ 12,60	€ 15,00	215 38 220
	H30	2,7 m	SK	€ 35,60	€ 42,35	215 38 305
		1,0 m	SK	€ 13,60	€ 16,20	215 38 301
		0,9 m	SK	€ 12,60	€ 15,00	215 38 300
	H31	2,7 m	SK	€ 35,60	€ 42,35	215 38 315
		1,0 m	SK	€ 13,60	€ 16,20	215 38 311
		0,9 m	SK	€ 12,60	€ 15,00	215 38 310
	H33	2,7 m	SK	€ 35,60	€ 42,35	215 38 335
		1,0 m	SK	€ 13,60	€ 16,20	215 38 331
		0,9 m	SK	€ 12,60	€ 15,00	215 38 330
	H40	2,7 m	SK	€ 35,60	€ 42,35	215 38 405
		1,0 m	SK	€ 13,60	€ 16,20	215 38 401
		0,9 m	SK	€ 12,60	€ 15,00	215 38 400
	H61	2,7 m	SK	€ 35,60	€ 42,35	215 38 615
		1,0 m	SK	€ 13,60	€ 16,20	215 38 611
		0,9 m	SK	€ 12,60	€ 15,00	215 38 610
	H62	2,7 m	SK	€ 35,60	€ 42,35	215 38 625
		1,0 m	SK	€ 13,60	€ 16,20	215 38 621
		0,9 m	SK	€ 12,60	€ 15,00	215 38 620
	H63	2,7 m	SK	€ 35,60	€ 42,35	215 38 635
		1,0 m	SK	€ 13,60	€ 16,20	215 38 631
		0,9 m	SK	€ 12,60	€ 15,00	215 38 630
	H64	2,7 m	SK	€ 35,60	€ 42,35	215 38 645
		1,0 m	SK	€ 13,60	€ 16,20	215 38 641
		0,9 m	SK	€ 12,60	€ 15,00	215 38 640
	H65	2,7 m	SK	€ 35,60	€ 42,35	215 38 655
		1,0 m	SK	€ 13,60	€ 16,20	215 38 651
		0,9 m	SK	€ 12,60	€ 15,00	215 38 650
	H80	2,7 m	SK	€ 35,60	€ 42,35	215 38 805
		1,0 m	SK	€ 13,60	€ 16,20	215 38 801
		0,9 m	SK	€ 12,60	€ 15,00	215 38 800
	H81	2,7 m	SK	€ 35,60	€ 42,35	215 38 835
		1,0 m	SK	€ 13,60	€ 16,20	215 38 831
		0,9 m	SK	€ 12,60	€ 15,00	215 38 830
	H95	2,7 m	SK	€ 35,60	€ 42,35	215 38 955
		1,0 m	SK	€ 13,60	€ 16,20	215 38 951
		0,9 m	SK	€ 12,60	€ 15,00	215 38 950
470 S	F4	3,0 m	S	€ 107,40	€ 127,80	313 470 004 8
	F2	3,0 m	S	€ 117,60	€ 139,95	313 470 002 8
231	F4	5,0 m	M	€ 52,00	€ 61,90	312 31 047
		3,0 m	M	€ 31,20	€ 37,15	312 31 048
		2,7 m	M	€ 28,10	€ 33,45	312 31 045
		1,0 m	M	€ 10,90	€ 12,95	312 31 041
	F5	5,0 m	M	€ 57,50	€ 68,45	312 31 057
		3,0 m	M	€ 34,50	€ 41,05	312 31 058
		2,7 m	M	€ 31,10	€ 37,00	312 31 055
		1,0 m	M	€ 11,80	€ 14,05	312 31 051
	F9	5,0 m	M	€ 52,00	€ 61,90	312 31 097
		3,0 m	M	€ 31,20	€ 37,15	312 31 098
		2,7 m	M	€ 28,10	€ 33,45	312 31 095
		1,0 m	M	€ 10,90	€ 12,95	312 31 091
	F6	5,0 m	M	€ 57,50	€ 68,45	312 31 067
		3,0 m	M	€ 34,50	€ 41,05	312 31 068
		2,7 m	M	€ 31,10	€ 37,00	312 31 065
		1,0 m	M	€ 11,80	€ 14,05	312 31 061
	F2	5,0 m	M	€ 57,50	€ 68,45	312 31 027
		3,0 m	M	€ 34,50	€ 41,05	312 31 028
		2,7 m	M	€ 31,10	€ 37,00	312 31 025
		1,0 m	M	€ 11,80	€ 14,05	312 31 021
	F4	5,0 m	SK	€ 58,00	€ 69,00	215 31 047
		3,0 m	SK	€ 34,80	€ 41,40	215 31 048
		2,7 m	SK	€ 31,30	€ 37,25	215 31 045
		1,0 m	SK	€ 12,10	€ 14,40	215 31 041
	F5	5,0 m	SK	€ 63,50	€ 75,55	215 31 057
		3,0 m	SK	€ 38,10	€ 45,35	215 31 058
		2,7 m	SK	€ 34,30	€ 40,80	215 31 055
		1,0 m	SK	€ 13,30	€ 15,85	215 31 051
	F9	5,0 m	SK	€ 58,00	€ 69,00	215 31 097
		3,0 m	SK	€ 34,80	€ 41,40	215 31 098
		2,7 m	SK	€ 31,30	€ 37,25	215 31 095
		1,0 m	SK	€ 12,10	€ 14,40	215 31 091
	F6	5,0 m	SK	€ 63,50	€ 75,55	215 31 067
		3,0 m	SK	€ 38,10	€ 45,35	215 31 068
		2,7 m	SK	€ 34,30	€ 40,80	215 31 065
		1,0 m	SK	€ 13,30	€ 15,85	215 31 061
	F2	5,0 m	SK	€ 63,50	€ 75,55	215 31 027
		3,0 m	SK	€ 38,10	€ 45,35	215 31 028
		2,7 m	SK	€ 34,30	€ 40,80	215 31 025
		1,0 m	SK	€ 13,30	€ 15,85	215 31 021
F16 RAL9005		3,0 m	SK	€ 38,10	€ 45,35	215 231 701 8
		1,0 m	SK	€ 13,30	€ 15,85	215 231 701 1

Artikel	Farben	Länge	Version	Preis/Stück		Bestell-Nr.
				exkl. MwSt.	inkl. MwSt.	
article	colour	length	version	excl. VAT	incl. VAT	order no.
Wölbischiene Edelstahl und Messing						
Cover Strips Stainless Steel and Brass						
471	F8	2,7 m	U	€ 20,00	€ 23,80	211 471 408 5
		1,0 m	U	€ 8,10	€ 9,65	211 471 408 1
		0,9 m	U	€ 7,50	€ 8,95	211 471 408 0
	F8	5,0 m	M	€ 41,00	€ 48,80	312 471 408 7
		2,7 m	M	€ 22,10	€ 26,30	312 471 408 5
		1,0 m	M	€ 8,30	€ 9,90	312 471 408 1
		0,9 m	M	€ 7,60	€ 9,05	312 471 408 0
	F8	2,7 m	S	€ 22,10	€ 26,30	313 471 408 5
		1,0 m	S	€ 8,30	€ 9,90	313 471 408 1
		0,9 m	S	€ 7,60	€ 9,05	313 471 408 0
	F8	5,0 m	SK	€ 45,00	€ 53,55	215 471 408 7
		2,7 m	SK	€ 24,30	€ 28,90	215 471 408 5
		1,0 m	SK	€ 9,20	€ 10,95	215 471 408 1
		0,9 m	SK	€ 8,30	€ 9,90	215 471 408 0
	F8G	2,7 m	U	€ 21,60	€ 25,70	211 471 402 5
		1,0 m	U	€ 8,90	€ 10,60	211 471 402 1
		0,9 m	U	€ 8,10	€ 9,65	211 471 402 0
	F8G	5,0 m	M	€ 44,50	€ 52,95	312 471 402 7
		2,7 m	M	€ 24,00	€ 28,55	312 471 402 5
		1,0 m	M	€ 9,10	€ 10,85	312 471 402 1
		0,9 m	M	€ 8,20	€ 9,75	312 471 402 0
	F8G	2,7 m	S	€ 24,00	€ 28,55	313 471 402 5
		1,0 m	S	€ 9,10	€ 10,85	313 471 402 1
		0,9 m	S	€ 8,20	€ 9,75	313 471 402 0
	F8G	5,0 m	SK	€ 48,50	€ 57,70	215 471 402 7
		2,7 m	SK	€ 26,20	€ 31,20	215 471 402 5
		1,0 m	SK	€ 9,90	€ 11,80	215 471 402 1
		0,9 m	SK	€ 9,00	€ 10,70	215 471 402 0
450	F7	5,0 m	M	€ 82,00	€ 97,60	312 50 077
		2,7 m	M	€ 44,30	€ 52,70	312 50 075
		1,0 m	M	€ 16,70	€ 19,85	312 50 071
		0,9 m	M	€ 15,10	€ 17,95	312 50 070
472	F8	2,7 m	U	€ 24,60	€ 29,25	211 472 408 5
		1,0 m	U	€ 10,00	€ 11,90	211 472 408 1
		0,9 m	U	€ 9,10	€ 10,85	211 472 408 0
	F8	5,0 m	M	€ 50,00	€ 59,50	312 472 408 7
		2,7 m	M	€ 27,00	€ 32,15	312 472 408 5
		1,0 m	M	€ 10,30	€ 12,25	312 472 408 1
		0,9 m	M	€ 9,40	€ 11,20	312 472 408 0
	F8	2,7 m	S	€ 27,00	€ 32,15	313 472 408 5
		1,0 m	S	€ 10,30	€ 12,25	313 472 408 1
		0,9 m	S	€ 9,40	€ 11,20	313 472 408 0
	F8	5,0 m	SK	€ 55,00	€ 65,45	215 472 408 7
		2,7 m	SK	€ 29,70	€ 35,35	215 472 408 5
		1,0 m	SK	€ 11,00	€ 13,10	215 472 408 1
		0,9 m	SK	€ 10,10	€ 12,00	215 472 408 0
	F8G	2,7 m	U	€ 27,50	€ 32,75	211 472 402 5
		1,0 m	U	€ 10,90	€ 12,95	211 472 402 1
		0,9 m	U	€ 10,10	€ 12,00	211 472 402 0
	F8G	5,0 m	M	€ 56,00	€ 66,65	312 472 402 7
		2,7 m	M	€ 30,20	€ 35,95	312 472 402 5
		1,0 m	M	€ 11,20	€ 13,35	312 472 402 1
		0,9 m	M	€ 10,30	€ 12,25	312 472 402 0
	F8G	2,7 m	S	€ 30,20	€ 35,95	313 472 402 5
		1,0 m	S	€ 11,20	€ 13,35	313 472 402 1
		0,9 m	S	€ 10,30	€ 12,25	313 472 402 0
	F8G	5,0 m	SK	€ 59,50	€ 70,80	215 472 402 7
		2,7 m	SK	€ 32,10	€ 38,20	215 472 402 5
		1,0 m	SK	€ 11,90	€ 14,15	215 472 402 1
		0,9 m	SK	€ 10,90	€ 12,95	215 472 402 0
451	F8	5,0 m	U	€ 38,50	€ 45,80	211 51 087
		2,7 m	U	€ 20,80	€ 24,75	211 51 085
		1,0 m	U	€ 8,10	€ 9,65	211 51 081
		0,9 m	U	€ 7,50	€ 8,95	211 51 080
	F8	5,0 m	M	€ 43,00	€ 51,15	312 51 087
		2,7 m	M	€ 23,20	€ 27,60	312 51 085
		1,0 m	M	€ 8,70	€ 10,35	312 51 081
		0,9 m	M	€ 8,00	€ 9,50	312 51 080
	F8	5,0 m	S	€ 43,00	€ 51,15	313 51 087
		2,7 m	S	€ 23,20	€ 27,60	313 51 085
		1,0 m	S	€ 8,70	€ 10,35	313 51 081
		0,9 m	S	€ 8,00	€ 9,50	313 51 080
	F8	5,0 m	SK	€ 45,50	€ 54,15	215 51 087
		2,7 m	SK	€ 24,60	€ 29,25	215 51 085
		1,0 m	SK	€ 9,40	€ 11,20	215 51 081
		0,9 m	SK	€ 8,70	€ 10,35	215 51 080
	F8G	5,0 m	U	€ 44,50	€ 52,95	211 51 027
		2,7 m	U	€ 24,00	€ 28,55	211 51 025
		1,0 m	U	€ 9,40	€ 11,20	211 51 021

Wölbsschienen / Cover Strips

Artikel	Farben	Länge	Version	Preis/Stück	unit price	Bestell-Nr.
article	colour	length	version	exkl. MwSt.	inkl. MwSt.	order no.
		0,9 m	U	€ 8,50	€ 10,10	211 51 020
	F8G	5,0 m	M	€ 48,50	€ 57,70	312 51 027
		2,7 m	M	€ 26,20	€ 31,20	312 51 025
		1,0 m	M	€ 10,10	€ 12,00	312 51 021
	F8G	0,9 m	M	€ 9,30	€ 11,05	312 51 020
		5,0 m	S	€ 48,50	€ 57,70	313 51 027
		2,7 m	S	€ 26,20	€ 31,20	313 51 025
		1,0 m	S	€ 10,10	€ 12,00	313 51 021
	F8G	0,9 m	S	€ 9,30	€ 11,05	313 51 020
		5,0 m	SK	€ 52,50	€ 62,50	215 51 027
		2,7 m	SK	€ 28,40	€ 33,80	215 51 025
		1,0 m	SK	€ 10,60	€ 12,60	215 51 021
	F7	0,9 m	SK	€ 9,80	€ 11,65	215 51 020
		5,0 m	M	€ 92,00	€ 109,50	312 51 077
		2,7 m	M	€ 49,70	€ 59,15	312 51 075
		1,0 m	M	€ 18,50	€ 22,00	312 51 071
	F7	0,9 m	M	€ 16,90	€ 20,10	312 51 070
		5,0 m	S	€ 92,50	€ 110,10	313 51 077
		2,7 m	S	€ 50,00	€ 59,50	313 51 075
		1,0 m	S	€ 18,60	€ 22,15	313 51 071
	F7	0,9 m	S	€ 17,00	€ 20,25	313 51 070
		2,7 m	SK	€ 50,80	€ 60,45	215 51 075
		1,0 m	SK	€ 19,10	€ 22,75	215 51 071
		0,9 m	SK	€ 17,50	€ 20,85	215 51 070
453	F7	2,7 m	M	€ 57,00	€ 67,85	312 53 075
		1,0 m	M	€ 21,30	€ 25,35	312 53 071
	F7	2,7 m	SK	€ 58,60	€ 69,75	215 53 075
		1,0 m	SK	€ 21,90	€ 26,05	215 53 071
452	F7	5,0 m	U	€ 110,00	€ 130,90	211 52 077
		2,7 m	U	€ 59,40	€ 70,70	211 52 075
	F7	5,0 m	M	€ 114,00	€ 135,65	312 52 077
		2,7 m	M	€ 61,60	€ 73,30	312 52 075
		1,0 m	M	€ 22,90	€ 27,25	312 52 071
		0,9 m	M	€ 21,00	€ 25,00	312 52 070
	F7	5,0 m	S	€ 114,50	€ 136,25	313 52 077
		2,7 m	S	€ 61,80	€ 73,55	313 52 075
		1,0 m	S	€ 22,90	€ 27,25	313 52 071
		0,9 m	S	€ 21,00	€ 25,00	313 52 070
	F7	2,7 m	SK	€ 62,90	€ 74,85	215 52 075
		1,0 m	SK	€ 23,70	€ 28,20	215 52 071
		0,9 m	SK	€ 21,60	€ 25,70	215 52 070
473	F8	2,7 m	U	€ 38,10	€ 45,35	211 473 408 5
		1,0 m	U	€ 14,70	€ 17,50	211 473 408 1
		0,9 m	U	€ 13,50	€ 16,05	211 473 408 0
	F8	5,0 m	M	€ 75,50	€ 89,85	312 473 408 7
		2,7 m	M	€ 40,80	€ 48,55	312 473 408 5
		1,0 m	M	€ 15,20	€ 18,10	312 473 408 1
		0,9 m	M	€ 13,90	€ 16,55	312 473 408 0
	F8	2,7 m	S	€ 40,80	€ 48,55	313 473 408 5
		1,0 m	S	€ 15,20	€ 18,10	313 473 408 1
		0,9 m	S	€ 13,90	€ 16,55	313 473 408 0
	F8	5,0 m	SK	€ 79,50	€ 94,60	215 473 408 7
		2,7 m	SK	€ 42,90	€ 51,05	215 473 408 5
		1,0 m	SK	€ 16,00	€ 19,05	215 473 408 1
		0,9 m	SK	€ 14,50	€ 17,25	215 473 408 0
	F8G	2,7 m	U	€ 43,20	€ 51,40	211 473 402 5
		1,0 m	U	€ 16,80	€ 20,00	211 473 402 1
		0,9 m	U	€ 15,20	€ 18,10	211 473 402 0
	F8G	5,0 m	M	€ 85,00	€ 101,15	312 473 402 7
		2,7 m	M	€ 45,90	€ 54,60	312 473 402 5
		1,0 m	M	€ 17,20	€ 20,45	312 473 402 1
		0,9 m	M	€ 15,70	€ 18,70	312 473 402 0
	F8G	2,7 m	S	€ 45,90	€ 54,60	313 473 402 5
		1,0 m	S	€ 17,20	€ 20,45	313 473 402 1
		0,9 m	S	€ 15,70	€ 18,70	313 473 402 0
	F8G	5,0 m	SK	€ 89,50	€ 106,50	215 473 402 7
		2,7 m	SK	€ 48,30	€ 57,50	215 473 402 5
		1,0 m	SK	€ 18,00	€ 21,40	215 473 402 1
		0,9 m	SK	€ 16,40	€ 19,50	215 473 402 0
456	F7	5,4 m	U	€ 183,10	€ 217,90	211 56 077
		2,7 m	U	€ 91,50	€ 108,90	211 56 075
	F7	5,4 m	M	€ 192,80	€ 229,45	312 56 077
		2,7 m	M	€ 96,40	€ 114,70	312 56 075
	F7	5,4 m	S	€ 193,90	€ 230,75	313 56 077
		2,7 m	S	€ 96,90	€ 115,30	313 56 075
457	F7	5,4 m	U	€ 301,30	€ 358,55	211 57 077
		2,7 m	U	€ 150,70	€ 179,35	211 57 075
	F7	5,4 m	M	€ 310,50	€ 369,50	312 57 077
		2,7 m	M	€ 155,30	€ 184,80	312 57 075
	F7	5,4 m	S	€ 311,60	€ 370,80	313 57 077
		2,7 m	S	€ 155,80	€ 185,40	313 57 075
454	F8	5,0 m	U	€ 45,50	€ 54,15	211 54 087
		2,7 m	U	€ 24,60	€ 29,25	211 54 085
		1,0 m	U	€ 9,70	€ 11,55	211 54 081
		0,9 m	U	€ 8,90	€ 10,60	211 54 080

Artikel	Farben	Länge	Version	Preis/Stück	unit price	Bestell-Nr.
article	colour	length	version	exkl. MwSt.	inkl. MwSt.	order no.
	F8	5,0 m	M	€ 49,50	€ 58,90	312 54 087
		2,7 m	M	€ 26,70	€ 31,75	312 54 085
		1,0 m	M	€ 10,20	€ 12,15	312 54 081
		0,9 m	M	€ 9,40	€ 11,20	312 54 080
	F8	5,0 m	S	€ 50,00	€ 59,50	313 54 087
		2,7 m	S	€ 27,00	€ 32,15	313 54 085
		1,0 m	S	€ 10,30	€ 12,25	313 54 081
		0,9 m	S	€ 9,50	€ 11,30	313 54 080
	F8G	5,0 m	U	€ 53,50	€ 63,65	211 54 027
		2,7 m	U	€ 28,90	€ 34,40	211 54 025
		1,0 m	U	€ 11,20	€ 13,35	211 54 021
		0,9 m	U	€ 10,20	€ 12,15	211 54 020
	F8G	5,0 m	M	€ 58,00	€ 69,00	312 54 027
		2,7 m	M	€ 31,30	€ 37,25	312 54 025
		1,0 m	M	€ 11,80	€ 14,05	312 54 021
		0,9 m	M	€ 10,90	€ 12,95	312 54 020
	F8G	5,0 m	S	€ 58,00	€ 69,00	313 54 027
		2,7 m	S	€ 31,30	€ 37,25	313 54 025
		1,0 m	S	€ 11,80	€ 14,05	313 54 021
		0,9 m	S	€ 10,90	€ 12,95	313 54 020
	F7	5,0 m	U	€ 139,00	€ 165,40	211 54 077
		2,7 m	U	€ 75,10	€ 89,35	211 54 075
		1,0 m	U	€ 28,10	€ 33,45	211 54 071
		0,9 m	U	€ 25,40	€ 30,25	211 54 070
	F7	5,0 m	M	€ 143,50	€ 170,75	312 54 077
		2,7 m	M	€ 77,50	€ 92,25	312 54 075
		1,0 m	M	€ 28,80	€ 34,25	312 54 071
		0,9 m	M	€ 26,40	€ 31,40	312 54 070
	F7	5,0 m	S	€ 144,00	€ 171,35	313 54 077
		2,7 m	S	€ 77,80	€ 92,60	313 54 075
		1,0 m	S	€ 28,90	€ 34,40	313 54 071
		0,9 m	S	€ 26,50	€ 31,55	313 54 070
474	F8	5,0 m	U	€ 96,00	€ 114,25	211 474 408 7
		2,7 m	U	€ 51,80	€ 61,65	211 474 408 5
	F8	5,0 m	M	€ 100,00	€ 119,00	312 474 408 7
		2,7 m	M	€ 54,00	€ 64,25	312 474 408 5
	F8	5,0 m	S	€ 100,00	€ 119,00	313 474 408 7
		2,7 m	S	€ 54,00	€ 64,25	313 474 408 5
	F8G	5,0 m	U	€ 112,00	€ 133,30	2 11 74 02 7
		2,7 m	U	€ 60,50	€ 72,00	2 11 74 02 5
	F8G	5,0 m	M	€ 116,50	€ 138,65	3 12 74 02 7
		2,7 m	M	€ 62,90	€ 74,85	3 12 74 02 5
	F8G	5,0 m	S	€ 116,50	€ 138,65	3 13 74 02 7
		2,7 m	S	€ 62,90	€ 74,85	3 13 74 02 5
455	F8	5,0 m	U	€ 64,00	€ 76,15	211 55 087
		2,7 m	U	€ 34,60	€ 41,15	211 55 085
		1,0 m	U	€ 13,30	€ 15,85	211 55 081
		0,9 m	U	€ 12,20	€ 14,50	211 55 080
	F8	5,0 m	M	€ 68,50	€ 81,50	312 55 087
		2,7 m	M	€ 37,00	€ 44,05	312 55 085
		1,0 m	M	€ 13,90	€ 16,55	312 55 081
		0,9 m	M	€ 12,90	€ 15,35	312 55 080
	F8	5,0 m	S	€ 68,50	€ 81,50	313 55 087
		2,7 m	S	€ 37,00	€ 44,05	313 55 085
		1,0 m	S	€ 13,90	€ 16,55	313 55 081
		0,9 m	S	€ 12,90	€ 15,35	313 55 080
	F8G	5,0 m	U	€ 76,00	€ 90,45	211 55 027
		2,7 m	U	€ 41,00	€ 48,80	211 55 025
		1,0 m	U	€ 15,60	€ 18,55	211 55 021
		0,9 m	U	€ 14,20	€ 16,90	211 55 020
	F8G	5,0 m	M	€ 80,50	€ 95,80	312 55 027
		2,7 m	M	€ 43,50	€ 51,75	312 55 025
		1,0 m	M	€ 16,40	€ 19,50	312 55 021
		0,9 m	M	€ 14,80	€ 17,60	312 55 020
	F8G	5,0 m	S	€ 80,50	€ 95,80	313 55 027
		2,7 m	S	€ 43,50	€ 51,75	313 55 025
		1,0 m	S	€ 16,40	€ 19,50	313 55 021
		0,9 m	S	€ 14,80	€ 17,60	313 55 020
	F7	5,0 m	U	€ 179,00	€ 213,00	211 55 077
		2,7 m	U	€ 96,70	€ 115,05	211 55 075
		1,0 m	U	€ 35,90	€ 42,70	211 55 071
		0,9 m	U	€ 32,50	€ 38,70	211 55 070
	F7	5,0 m	M	€ 183,00	€ 217,75	312 55 077
		2,7 m	M	€ 98,80	€ 117,55	312 55 075
		1,0 m	M	€ 36,50	€ 43,45	312 55 071
		0,9 m	M	€ 33,20	€ 39,50	312 55 070
	F7	5,0 m	S	€ 183,50	€ 218,35	313 55 077
		2,7 m	S	€ 99,10	€ 117,95	313 55 075
		1,0 m	S	€ 36,80	€ 43,80	313 55 071
		0,9 m	S	€ 33,30	€ 39,65	313 55 070
475	F8	5,0 m	U	€ 113,00	€ 134,45	211 475 408 7
		2,7 m	U	€ 61,00	€ 72,60	211 475 408 5
	F8	5,0 m	M	€ 117,50	€ 139,85	312 475 408 7
		2,7 m	M	€ 63,50	€ 75,55	312 475 408 5
	F8	5,0 m	S	€ 117,50	€ 139,85	313 475 408 7

Artikel	Farben	Länge	Version	Preis/Stück	unit price	Bestell-Nr.
article	colour	length	version	inkl. MwSt. incl. VAT	inkl. MwSt. incl. VAT	order no.
		2,7 m	S	€ 63,50	€ 75,55	313 475 408 5
	F8G	5,0 m	U	€ 132,00	€ 157,10	2 11 75 02 7
		2,7 m	U	€ 71,30	€ 84,85	2 11 75 02 5
	F8G	5,0 m	M	€ 136,00	€ 161,85	3 12 75 02 7
		2,7 m	M	€ 73,40	€ 87,35	3 12 75 02 5
	F8G	5,0 m	S	€ 136,00	€ 161,85	3 13 75 02 7
		2,7 m	S	€ 73,40	€ 87,35	3 13 75 02 5
167	F7	5,0 m	U	€ 274,00	€ 326,05	211 67 077
		2,5 m	U	€ 137,00	€ 163,05	211 67 074
	F7	5,0 m	M	€ 281,00	€ 334,40	312 67 077
		2,5 m	M	€ 140,50	€ 167,20	312 67 074
	F7	5,0 m	S	€ 282,00	€ 335,60	313 67 077
		2,5 m	S	€ 141,00	€ 167,80	313 67 074



Abschluss-, Einfass- und Rampenprofile
Edge Trims and Ramp Profiles

Artikel	Farben	Länge	Version	Preis/Stück	unit price	Bestell-Nr.
article	colour	length	version	inkl. MwSt. incl. VAT	inkl. MwSt. incl. VAT	order no.
250	F4	5,0 m	U	€ 55,00	€ 65,45	211 50 047
		2,7 m	U	€ 29,70	€ 35,35	211 50 045
	F5	5,0 m	U	€ 60,50	€ 72,00	211 50 057
		2,7 m	U	€ 32,70	€ 38,90	211 50 055
	F9	5,0 m	U	€ 55,00	€ 65,45	211 50 097
		2,7 m	U	€ 29,70	€ 35,35	211 50 095
	F6	5,0 m	U	€ 60,50	€ 72,00	211 50 067
		2,7 m	U	€ 32,70	€ 38,90	211 50 065
	F2G	5,0 m	U	€ 69,00	€ 82,10	211 50 027
		2,7 m	U	€ 37,30	€ 44,40	211 50 025
	F3	5,0 m	S	€ 60,00	€ 71,40	317 50 037
		2,7 m	S	€ 32,40	€ 38,55	317 50 035
	F4	5,0 m	S	€ 60,00	€ 71,40	317 50 047
		2,7 m	S	€ 32,40	€ 38,55	317 50 045
		0,9 m	S	€ 11,50	€ 13,70	317 50 040
	F5	5,0 m	S	€ 66,00	€ 78,55	317 50 057
		2,7 m	S	€ 35,60	€ 42,35	317 50 055
	F9	5,0 m	S	€ 60,00	€ 71,40	317 50 097
		2,7 m	S	€ 32,40	€ 38,55	317 50 095
	F6	5,0 m	S	€ 66,00	€ 78,55	317 50 067
		2,7 m	S	€ 35,60	€ 42,35	317 50 065
	F2G	5,0 m	S	€ 74,00	€ 88,05	317 50 027
		2,7 m	S	€ 40,00	€ 47,60	317 50 025
240	F3	5,0 m	V	€ 48,00	€ 57,10	317 40 037
		2,7 m	V	€ 25,90	€ 30,80	317 40 035
		1,0 m	V	€ 10,20	€ 12,15	317 40 031
		0,9 m	V	€ 9,40	€ 11,20	317 40 030
	F4	5,0 m	V	€ 48,00	€ 57,10	317 40 047
		2,7 m	V	€ 25,90	€ 30,80	317 40 045
		1,0 m	V	€ 10,20	€ 12,15	317 40 041
		0,9 m	V	€ 9,40	€ 11,20	317 40 040
	F5	5,0 m	V	€ 54,00	€ 64,25	317 40 057
		2,7 m	V	€ 29,20	€ 34,75	317 40 055
		1,0 m	V	€ 11,20	€ 13,35	317 40 051
		0,9 m	V	€ 10,30	€ 12,25	317 40 050
	F9	5,0 m	V	€ 48,00	€ 57,10	317 40 097
		2,7 m	V	€ 25,90	€ 30,80	317 40 095
		1,0 m	V	€ 10,20	€ 12,15	317 40 091
		0,9 m	V	€ 9,40	€ 11,20	317 40 090
	F6	5,0 m	V	€ 54,00	€ 64,25	317 40 067
		2,7 m	V	€ 29,20	€ 34,75	317 40 065
		1,0 m	V	€ 11,20	€ 13,35	317 40 061
		0,9 m	V	€ 10,30	€ 12,25	317 40 060
	F2	5,0 m	V	€ 54,00	€ 64,25	317 40 027
		2,7 m	V	€ 29,20	€ 34,75	317 40 025

Artikel	Farben	Länge	Version	Preis/Stück	unit price	Bestell-Nr.
article	colour	length	version	inkl. MwSt. incl. VAT	inkl. MwSt. incl. VAT	order no.
		1,0 m	V	€ 11,20	€ 13,35	317 40 021
		0,9 m	V	€ 10,30	€ 12,25	317 40 020
	F7	5,0 m	V	€ 191,00	€ 227,30	317 40 077
		2,7 m	V	€ 103,10	€ 122,70	317 40 075
		1,0 m	V	€ 38,60	€ 45,95	317 40 071
		0,9 m	V	€ 35,00	€ 41,65	317 40 070
	F3	2,7 m	SK	€ 29,70	€ 35,35	215 40 035
		0,9 m	SK	€ 10,10	€ 12,00	215 40 030
	F4	2,7 m	SK	€ 29,70	€ 35,35	215 40 045
		1,0 m	SK	€ 11,60	€ 13,80	215 40 041
		0,9 m	SK	€ 10,10	€ 12,00	215 40 040
	F5	2,7 m	SK	€ 32,10	€ 38,20	215 40 055
		0,9 m	SK	€ 10,90	€ 12,95	215 40 050
	F9	2,7 m	SK	€ 29,70	€ 35,35	215 40 095
		1,0 m	SK	€ 11,60	€ 13,80	215 40 091
		0,9 m	SK	€ 10,10	€ 12,00	215 40 090
	F6	2,7 m	SK	€ 32,10	€ 38,20	215 40 065
		0,9 m	SK	€ 10,90	€ 12,95	215 40 060
	F2	2,7 m	SK	€ 32,10	€ 38,20	215 40 025
		1,0 m	SK	€ 12,60	€ 15,00	215 40 021
		0,9 m	SK	€ 10,90	€ 12,95	215 40 020
	F15 RAL9016	2,7 m	SK	€ 35,90	€ 42,70	215 240 715 5
		0,9 m	SK	€ 11,90	€ 14,15	215 240 715 0
	F16 RAL9005	2,7 m	SK	€ 35,90	€ 42,70	215 240 701 5
		0,9 m	SK	€ 11,90	€ 14,15	215 240 701 0
244	F4	3,0 m	V	€ 36,90	€ 43,90	317 44 048
		2,7 m	V	€ 33,20	€ 39,50	317 44 045
		1,0 m	V	€ 12,90	€ 15,35	317 44 041
		0,9 m	V	€ 11,60	€ 13,80	317 44 040
	F5	3,0 m	V	€ 40,20	€ 47,85	317 44 058
		2,7 m	V	€ 36,20	€ 43,10	317 44 055
		0,9 m	V	€ 12,40	€ 14,75	317 44 050
	F9	3,0 m	V	€ 36,90	€ 43,90	317 44 098
		2,7 m	V	€ 33,20	€ 39,50	317 44 095
		1,0 m	V	€ 12,90	€ 15,35	317 44 091
		0,9 m	V	€ 11,60	€ 13,80	317 44 090
	F6	3,0 m	V	€ 40,20	€ 47,85	317 44 068
		2,7 m	V	€ 36,20	€ 43,10	317 44 065
		0,9 m	V	€ 12,40	€ 14,75	317 44 060
	F2	3,0 m	V	€ 40,20	€ 47,85	317 44 028
		2,7 m	V	€ 36,20	€ 43,10	317 44 025
		1,0 m	V	€ 14,00	€ 16,65	317 44 021
		0,9 m	V	€ 12,40	€ 14,75	317 44 020
	F4	3,0 m	SK	€ 39,60	€ 47,10	215 44 048
		2,7 m	SK	€ 35,60	€ 42,35	215 44 045
		1,0 m	SK	€ 13,40	€ 15,95	215 44 041
		0,9 m	SK	€ 12,90	€ 15,35	215 44 040
	F5	3,0 m	SK	€ 42,30	€ 50,35	215 44 058
		2,7 m	SK	€ 38,10	€ 45,35	215 44 055
		0,9 m	SK	€ 13,00	€ 15,45	215 44 050
	F9	3,0 m	SK	€ 39,60	€ 47,10	215 44 098
		2,7 m	SK	€ 35,60	€ 42,35	215 44 095
		1,0 m	SK	€ 13,40	€ 15,95	215 44 091
		0,9 m	SK	€ 12,90	€ 15,35	215 44 090
	F6	3,0 m	SK	€ 42,30	€ 50,35	215 44 068
		2,7 m	SK	€ 38,10	€ 45,35	215 44 065
		0,9 m	SK	€ 13,00	€ 15,45	215 44 060
	F2	3,0 m	SK	€ 42,30	€ 50,35	215 44 028
		2,7 m	SK	€ 38,10	€ 45,35	215 44 025
		1,0 m	SK	€ 14,30	€ 17,00	215 44 021
		0,9 m	SK	€ 13,00	€ 15,45	215 44 020
	F15 RAL9016	2,7 m	SK	€ 41,90	€ 49,85	215 244 715 5
		0,9 m	SK	€ 14,60	€ 17,35	215 244 715 0
	F16 RAL9005	3,0 m	SK	€ 46,50	€ 55,35	215 244 701 8
		2,7 m	SK	€ 41,90	€ 49,85	215 244 701 5
		0,9 m	SK	€ 14,60	€ 17,35	215 244 701 0
	H20	2,7 m	SK	€ 43,50	€ 51,75	215 44 205
		0,9 m	SK	€ 15,10	€ 17,95	215 44 200
	H22	2,7 m	SK	€ 43,50	€ 51,75	215 44 225
		0,9 m	SK	€ 15,10	€ 17,95	215 44 220
	H30	2,7 m	SK	€ 43,50	€ 51,75	215 44 305
		0,9 m	SK	€ 15,10	€ 17,95	215 44 300
	H31	2,7 m	SK	€ 43,50	€ 51,75	215 44 315
		0,9 m	SK	€ 15,10	€ 17,95	215 44 310
	H33	2,7 m	SK	€ 43,50	€ 51,75	215 44 335
		0,9 m	SK	€ 15,10	€ 17,95	215 44 330
	H40	2,7 m	SK	€ 43,50	€ 51,75	215 44 405
		0,9 m	SK	€ 15,10	€ 17,95	215 44 400
	H61	2,7 m	SK	€ 43,50	€ 51,75	215 44 615
		0,9 m	SK	€ 15,10	€ 17,95	215 44 610
	H62	2,7 m	SK	€ 43,50	€ 51,75	215 44 625
		0,9 m	SK	€ 15,10	€ 17,95	215 44 620
	H63	2,7 m	SK	€ 43,50	€ 51,75	215 44 635
		0,9 m	SK	€ 15,10	€ 17,95	215 44 630
	H64	2,7 m	SK	€ 43,50	€ 51,75	215 44 645

Abschluss-, Einfass- und Rampenprofile / Edge Trims and Ramp Profiles

Artikel	Farben	Länge	Version	Preis/Stück	unit price	Bestell-Nr.
article	colour	length	version	exkl. MwSt.	inkl. MwSt.	order no.
		0,9 m	SK	€ 15,10	€ 17,95	215 44 640
	H80	2,7 m	SK	€ 43,50	€ 51,75	215 44 805
		0,9 m	SK	€ 15,10	€ 17,95	215 44 800
	H81	2,7 m	SK	€ 43,50	€ 51,75	215 44 835
		0,9 m	SK	€ 15,10	€ 17,95	215 44 830
	H95	2,7 m	SK	€ 43,50	€ 51,75	215 44 955
		0,9 m	SK	€ 15,10	€ 17,95	215 44 950
241	F4	3,0 m	V	€ 43,80	€ 52,10	317 41 048
		2,7 m	V	€ 39,40	€ 46,90	317 41 045
		0,9 m	V	€ 13,60	€ 16,20	317 41 040
	F5	3,0 m	V	€ 48,60	€ 57,85	317 41 058
		2,7 m	V	€ 43,70	€ 52,00	317 41 055
		0,9 m	V	€ 14,80	€ 17,60	317 41 050
	F9	3,0 m	V	€ 43,80	€ 52,10	317 41 098
		2,7 m	V	€ 39,40	€ 46,90	317 41 095
		0,9 m	V	€ 13,60	€ 16,20	317 41 090
	F6	3,0 m	V	€ 48,60	€ 57,85	317 41 068
		2,7 m	V	€ 43,70	€ 52,00	317 41 065
		0,9 m	V	€ 14,80	€ 17,60	317 41 060
	F2	3,0 m	V	€ 48,60	€ 57,85	317 41 028
		2,7 m	V	€ 43,70	€ 52,00	317 41 025
		0,9 m	V	€ 14,80	€ 17,60	317 41 020
	F4	3,0 m	SK	€ 46,80	€ 55,70	215 41 048
		2,7 m	SK	€ 42,10	€ 50,10	215 41 045
		0,9 m	SK	€ 14,20	€ 16,90	215 41 040
	F5	3,0 m	SK	€ 51,00	€ 60,70	215 41 058
		2,7 m	SK	€ 45,90	€ 54,60	215 41 055
		0,9 m	SK	€ 15,70	€ 18,70	215 41 050
	F9	3,0 m	SK	€ 46,80	€ 55,70	215 41 098
		2,7 m	SK	€ 42,10	€ 50,10	215 41 095
		0,9 m	SK	€ 14,20	€ 16,90	215 41 090
	F6	3,0 m	SK	€ 51,00	€ 60,70	215 41 068
		2,7 m	SK	€ 45,90	€ 54,60	215 41 065
		0,9 m	SK	€ 15,70	€ 18,70	215 41 060
	F2	3,0 m	SK	€ 51,00	€ 60,70	215 41 028
		2,7 m	SK	€ 45,90	€ 54,60	215 41 025
		0,9 m	SK	€ 15,70	€ 18,70	215 41 020
	F15 RAL9016	2,7 m	SK	€ 50,50	€ 60,10	215 241 715 5
		0,9 m	SK	€ 17,30	€ 20,60	215 241 715 0
	F16 RAL9005	3,0 m	SK	€ 56,10	€ 66,75	215 241 701 8
		2,7 m	SK	€ 50,50	€ 60,10	215 241 701 5
		0,9 m	SK	€ 17,30	€ 20,60	215 241 701 0
	H20	2,7 m	SK	€ 48,30	€ 57,50	215 41 205
		0,9 m	SK	€ 16,30	€ 19,40	215 41 200
	H22	2,7 m	SK	€ 48,30	€ 57,50	215 41 225
		0,9 m	SK	€ 16,30	€ 19,40	215 41 220
	H30	2,7 m	SK	€ 48,30	€ 57,50	215 41 305
		0,9 m	SK	€ 16,30	€ 19,40	215 41 300
	H31	2,7 m	SK	€ 48,30	€ 57,50	215 41 315
		0,9 m	SK	€ 16,30	€ 19,40	215 41 310
	H33	2,7 m	SK	€ 48,30	€ 57,50	215 41 335
		0,9 m	SK	€ 16,30	€ 19,40	215 41 330
	H40	2,7 m	SK	€ 48,30	€ 57,50	215 41 405
		0,9 m	SK	€ 16,30	€ 19,40	215 41 400
	H61	2,7 m	SK	€ 48,30	€ 57,50	215 41 615
		0,9 m	SK	€ 16,30	€ 19,40	215 41 610
	H62	2,7 m	SK	€ 48,30	€ 57,50	215 41 625
		0,9 m	SK	€ 16,30	€ 19,40	215 41 620
	H63	2,7 m	SK	€ 48,30	€ 57,50	215 41 635
		0,9 m	SK	€ 16,30	€ 19,40	215 41 630
	H64	2,7 m	SK	€ 48,30	€ 57,50	215 41 645
		0,9 m	SK	€ 16,30	€ 19,40	215 41 640
	H80	2,7 m	SK	€ 48,30	€ 57,50	215 41 805
		0,9 m	SK	€ 16,30	€ 19,40	215 41 800
	H81	2,7 m	SK	€ 48,30	€ 57,50	215 41 835
		0,9 m	SK	€ 16,30	€ 19,40	215 41 830
	H95	2,7 m	SK	€ 48,30	€ 57,50	215 41 955
		0,9 m	SK	€ 16,30	€ 19,40	215 41 950
245	F4	5,0 m	V	€ 82,00	€ 97,60	317 45 047
		2,7 m	V	€ 44,30	€ 52,70	317 45 045
		0,9 m	V	€ 14,80	€ 17,60	317 45 040
	F5	5,0 m	V	€ 90,50	€ 107,70	317 45 057
		2,7 m	V	€ 48,90	€ 58,20	317 45 055
		0,9 m	V	€ 16,60	€ 19,75	317 45 050
	F9	5,0 m	V	€ 82,00	€ 97,60	317 45 097
		2,7 m	V	€ 44,30	€ 52,70	317 45 095
		0,9 m	V	€ 14,80	€ 17,60	317 45 090
	F6	5,0 m	V	€ 90,50	€ 107,70	317 45 067
		2,7 m	V	€ 48,90	€ 58,20	317 45 065
		0,9 m	V	€ 16,60	€ 19,75	317 45 060
	F2	5,0 m	V	€ 90,50	€ 107,70	317 45 027
		2,7 m	V	€ 48,90	€ 58,20	317 45 025
		0,9 m	V	€ 16,60	€ 19,75	317 45 020
	F4	5,0 m	SK	€ 86,50	€ 102,95	215 45 047
		2,7 m	SK	€ 46,70	€ 55,55	215 45 045

Artikel	Farben	Länge	Version	Preis/Stück	unit price	Bestell-Nr.
article	colour	length	version	exkl. MwSt.	inkl. MwSt.	order no.
		0,9 m	SK	€ 15,90	€ 18,90	215 45 040
	F5	5,0 m	SK	€ 93,50	€ 111,25	215 45 057
		2,7 m	SK	€ 50,50	€ 60,10	215 45 055
		0,9 m	SK	€ 17,40	€ 20,70	215 45 050
	F9	5,0 m	SK	€ 86,50	€ 102,95	215 45 097
		2,7 m	SK	€ 46,70	€ 55,55	215 45 095
		0,9 m	SK	€ 15,90	€ 18,90	215 45 090
	F6	5,0 m	SK	€ 93,50	€ 111,25	215 45 067
		2,7 m	SK	€ 50,50	€ 60,10	215 45 065
		0,9 m	SK	€ 17,40	€ 20,70	215 45 060
	F2	5,0 m	SK	€ 93,50	€ 111,25	215 45 027
		2,7 m	SK	€ 50,50	€ 60,10	215 45 025
		0,9 m	SK	€ 17,40	€ 20,70	215 45 020
	F15 RAL9016	2,7 m	SK	€ 55,90	€ 66,50	215 245 715 5
		0,9 m	SK	€ 19,10	€ 22,75	215 245 715 0
	F16 RAL9005	2,7 m	SK	€ 55,90	€ 66,50	215 245 701 5
		0,9 m	SK	€ 19,10	€ 22,75	215 245 701 0
243	F4	2,5 m	V	€ 28,30	€ 33,70	317 43 044
		1,0 m	V	€ 11,60	€ 13,80	317 43 041
	F2	2,5 m	V	€ 30,30	€ 36,05	317 43 024
		1,0 m	V	€ 12,70	€ 15,10	317 43 021
	F7	5,0 m	V	€ 204,50	€ 243,35	317 43 077
		2,5 m	V	€ 102,30	€ 121,75	317 43 074
		1,0 m	V	€ 41,10	€ 48,90	317 43 071
247	F3	3,0 m	V	€ 42,90	€ 51,05	317 247 003 8
		2,7 m	V	€ 38,60	€ 45,95	317 247 003 5
		1,0 m	V	€ 14,40	€ 17,15	317 247 003 1
	F4	3,0 m	V	€ 42,90	€ 51,05	317 247 004 8
		2,7 m	V	€ 38,60	€ 45,95	317 247 004 5
		1,0 m	V	€ 14,40	€ 17,15	317 247 004 1
	F5	3,0 m	V	€ 46,80	€ 55,70	317 247 005 8
		2,7 m	V	€ 42,10	€ 50,10	317 247 005 5
		1,0 m	V	€ 15,90	€ 18,90	317 247 005 1
	F9	3,0 m	V	€ 42,90	€ 51,05	317 247 009 8
		2,7 m	V	€ 38,60	€ 45,95	317 247 009 5
		1,0 m	V	€ 14,40	€ 17,15	317 247 009 1
	F6	3,0 m	V	€ 46,80	€ 55,70	317 247 006 8
		2,7 m	V	€ 42,10	€ 50,10	317 247 006 5
		1,0 m	V	€ 15,90	€ 18,90	317 247 006 1
	F2	3,0 m	V	€ 46,80	€ 55,70	317 247 002 8
		2,7 m	V	€ 42,10	€ 50,10	317 247 002 5
		1,0 m	V	€ 15,90	€ 18,90	317 247 002 1
	F7	2,7 m	V	€ 145,00	€ 172,55	317 247 307 5
		0,9 m	V	€ 48,90	€ 58,20	317 247 307 0
	F3	3,0 m	SK	€ 46,20	€ 55,00	215 247 003 8
		2,7 m	SK	€ 41,60	€ 49,50	215 247 003 5
		1,0 m	SK	€ 16,30	€ 19,40	215 247 003 1
	F4	3,0 m	SK	€ 46,20	€ 55,00	215 247 004 8
		2,7 m	SK	€ 41,60	€ 49,50	215 247 004 5
		1,0 m	SK	€ 16,30	€ 19,40	215 247 004 1
	F5	3,0 m	SK	€ 50,40	€ 60,00	215 247 005 8
		2,7 m	SK	€ 45,40	€ 54,05	215 247 005 5
		1,0 m	SK	€ 17,50	€ 20,85	215 247 005 1
	F9	3,0 m	SK	€ 46,20	€ 55,00	215 247 009 8
		2,7 m	SK	€ 41,60	€ 49,50	215 247 009 5
		1,0 m	SK	€ 16,30	€ 19,40	215 247 009 1
	F6	3,0 m	SK	€ 50,40	€ 60,00	215 247 006 8
		2,7 m	SK	€ 45,40	€ 54,05	215 247 006 5
		1,0 m	SK	€ 17,50	€ 20,85	215 247 006 1
	F2	3,0 m	SK	€ 50,40	€ 60,00	215 247 002 8
		2,7 m	SK	€ 45,40	€ 54,05	215 247 002 5
		1,0 m	SK	€ 17,50	€ 20,85	215 247 002 1
	F15 RAL9016	3,0 m	SK	€ 55,50	€ 66,05	215 247 715 8
		2,7 m	SK	€ 50,20	€ 59,75	215 247 715 5
		1,0 m	SK	€ 19,20	€ 22,85	215 247 715 1
		0,9 m	SK	€ 17,30	€ 20,60	215 247 715 0
	F16 RAL9005	3,0 m	SK	€ 55,50	€ 66,05	215 247 701 8
		2,7 m	SK	€ 50,20	€ 59,75	215 247 701 5
		1,0 m	SK			

Artikel	Farben	Länge	Version	Preis/Stück	unit price	Bestell-Nr.
article	colour	length	version	exkl. MwSt.	inkl. MwSt.	order no.
	H33	3,0 m	SK	€ 56,40	€ 67,10	215 247 133 8
		2,7 m	SK	€ 50,80	€ 60,45	215 247 133 5
		1,0 m	SK	€ 19,10	€ 22,75	215 247 133 1
		0,9 m	SK	€ 17,30	€ 20,60	215 247 133 0
	H40	3,0 m	SK	€ 56,40	€ 67,10	215 247 140 8
		2,7 m	SK	€ 50,80	€ 60,45	215 247 140 5
		1,0 m	SK	€ 19,10	€ 22,75	215 247 140 1
		0,9 m	SK	€ 17,30	€ 20,60	215 247 140 0
	H61	3,0 m	SK	€ 56,40	€ 67,10	215 247 161 8
		2,7 m	SK	€ 50,80	€ 60,45	215 247 161 5
		1,0 m	SK	€ 19,10	€ 22,75	215 247 161 1
		0,9 m	SK	€ 17,30	€ 20,60	215 247 161 0
	H62	3,0 m	SK	€ 56,40	€ 67,10	215 247 162 8
		2,7 m	SK	€ 50,80	€ 60,45	215 247 162 5
		1,0 m	SK	€ 19,10	€ 22,75	215 247 162 1
		0,9 m	SK	€ 17,30	€ 20,60	215 247 162 0
	H63	3,0 m	SK	€ 56,40	€ 67,10	215 247 163 8
		2,7 m	SK	€ 50,80	€ 60,45	215 247 163 5
		1,0 m	SK	€ 19,10	€ 22,75	215 247 163 1
		0,9 m	SK	€ 17,30	€ 20,60	215 247 163 0
	H64	3,0 m	SK	€ 56,40	€ 67,10	215 247 164 8
		2,7 m	SK	€ 50,80	€ 60,45	215 247 164 5
		1,0 m	SK	€ 19,10	€ 22,75	215 247 164 1
		0,9 m	SK	€ 17,30	€ 20,60	215 247 164 0
	H65	3,0 m	SK	€ 56,40	€ 67,10	215 247 165 8
		2,7 m	SK	€ 50,80	€ 60,45	215 247 165 5
		1,0 m	SK	€ 19,10	€ 22,75	215 247 165 1
		0,9 m	SK	€ 17,30	€ 20,60	215 247 165 0
	H80	3,0 m	SK	€ 56,40	€ 67,10	215 247 180 8
		2,7 m	SK	€ 50,80	€ 60,45	215 247 180 5
		1,0 m	SK	€ 19,10	€ 22,75	215 247 180 1
		0,9 m	SK	€ 17,30	€ 20,60	215 247 180 0
	H81	3,0 m	SK	€ 56,40	€ 67,10	215 247 181 8
		2,7 m	SK	€ 50,80	€ 60,45	215 247 181 5
		1,0 m	SK	€ 19,10	€ 22,75	215 247 181 1
		0,9 m	SK	€ 17,30	€ 20,60	215 247 181 0
	H95	3,0 m	SK	€ 56,40	€ 67,10	215 247 195 8
		2,7 m	SK	€ 50,80	€ 60,45	215 247 195 5
		1,0 m	SK	€ 19,10	€ 22,75	215 247 195 1
		0,9 m	SK	€ 17,30	€ 20,60	215 247 195 0
248	F3	3,0 m	V	€ 40,20	€ 47,85	317 248 003 8
		2,7 m	V	€ 36,20	€ 43,10	317 248 003 5
		1,0 m	V	€ 13,70	€ 16,30	317 248 003 1
	F4	3,0 m	V	€ 40,20	€ 47,85	317 248 004 8
		2,7 m	V	€ 36,20	€ 43,10	317 248 004 5
		1,0 m	V	€ 13,70	€ 16,30	317 248 004 1
	F4G	3,0 m	V	€ 46,20	€ 55,00	317 248 804 8
		1,0 m	V	€ 15,70	€ 18,70	317 248 804 1
	F9	3,0 m	V	€ 40,20	€ 47,85	317 248 009 8
		2,7 m	V	€ 36,20	€ 43,10	317 248 009 5
		1,0 m	V	€ 13,70	€ 16,30	317 248 009 1
	F2G	3,0 m	V	€ 46,20	€ 55,00	317 248 002 8
		2,7 m	V	€ 41,60	€ 49,50	317 248 002 5
		1,0 m	V	€ 15,70	€ 18,70	317 248 002 1
	F3	3,0 m	SK	€ 43,20	€ 51,40	215 248 003 8
		2,7 m	SK	€ 38,90	€ 46,30	215 248 003 5
		1,0 m	SK	€ 14,80	€ 17,60	215 248 003 1
	F4	3,0 m	SK	€ 43,20	€ 51,40	215 248 004 8
		2,7 m	SK	€ 38,90	€ 46,30	215 248 004 5
		1,0 m	SK	€ 14,80	€ 17,60	215 248 004 1
	F4G	3,0 m	SK	€ 49,20	€ 58,55	215 248 804 8
		1,0 m	SK	€ 16,80	€ 20,00	215 248 804 1
	F9	3,0 m	SK	€ 43,20	€ 51,40	215 248 009 8
		2,7 m	SK	€ 38,90	€ 46,30	215 248 009 5
		1,0 m	SK	€ 14,80	€ 17,60	215 248 009 1
	F2G	3,0 m	SK	€ 49,20	€ 58,55	215 248 002 8
		2,7 m	SK	€ 44,30	€ 52,70	215 248 002 5
		1,0 m	SK	€ 16,80	€ 20,00	215 248 002 1
	F15 RAL9016	3,0 m	SK	€ 53,10	€ 63,20	215 248 715 8
		2,7 m	SK	€ 47,80	€ 56,90	215 248 715 5
		1,0 m	SK	€ 18,50	€ 22,00	215 248 715 1
	F16 RAL9005	3,0 m	SK	€ 53,10	€ 63,20	215 248 701 8
		2,7 m	SK	€ 47,80	€ 56,90	215 248 701 5
		1,0 m	SK	€ 18,50	€ 22,00	215 248 701 1

Abschluss- und Einfassprofile
Edge trims

380	F4	5,0 m	V	€ 41,50	€ 49,40	317 80 047
		2,7 m	V	€ 22,40	€ 26,65	317 80 045
		0,9 m	V	€ 7,50	€ 8,95	317 80 040
	F5	5,0 m	V	€ 45,00	€ 53,55	317 80 057
		2,7 m	V	€ 24,30	€ 28,90	317 80 055

Artikel	Farben	Länge	Version	Preis/Stück	unit price	Bestell-Nr.
article	colour	length	version	exkl. MwSt.	inkl. MwSt.	order no.
		0,9 m	V	€ 8,10	€ 9,65	317 80 050
	F9	5,0 m	V	€ 41,50	€ 49,40	317 80 097
		2,7 m	V	€ 22,40	€ 26,65	317 80 095
		0,9 m	V	€ 7,50	€ 8,95	317 80 090
	F6	5,0 m	V	€ 45,00	€ 53,55	317 80 067
		2,7 m	V	€ 24,30	€ 28,90	317 80 065
		0,9 m	V	€ 8,10	€ 9,65	317 80 060
	F2G	5,0 m	V	€ 51,00	€ 60,70	317 80 027
		2,7 m	V	€ 27,50	€ 32,75	317 80 025
		0,9 m	V	€ 9,40	€ 11,20	317 80 020
	F4	2,7 m	SK	€ 26,50	€ 31,55	215 80 045
		0,9 m	SK	€ 9,10	€ 10,85	215 80 040
	F5	2,7 m	SK	€ 28,60	€ 34,05	215 80 055
		0,9 m	SK	€ 9,80	€ 11,65	215 80 050
	F9	2,7 m	SK	€ 26,50	€ 31,55	215 80 095
		0,9 m	SK	€ 9,10	€ 10,85	215 80 090
	F6	2,7 m	SK	€ 28,60	€ 34,05	215 80 065
		0,9 m	SK	€ 9,80	€ 11,65	215 80 060
	F2G	2,7 m	SK	€ 31,30	€ 37,25	215 80 025
		0,9 m	SK	€ 11,00	€ 13,10	215 80 020
390	F4	5,0 m	V	€ 41,50	€ 49,40	317 90 047
		2,7 m	V	€ 22,40	€ 26,65	317 90 045
		0,9 m	V	€ 7,50	€ 8,95	317 90 040
	F5	5,0 m	V	€ 46,00	€ 54,75	317 90 057
		2,7 m	V	€ 24,80	€ 29,50	317 90 055
		0,9 m	V	€ 8,40	€ 10,00	317 90 050
	F9	5,0 m	V	€ 41,50	€ 49,40	317 90 097
		2,7 m	V	€ 22,40	€ 26,65	317 90 095
		0,9 m	V	€ 7,50	€ 8,95	317 90 090
	F6	5,0 m	V	€ 46,00	€ 54,75	317 90 067
		2,7 m	V	€ 24,80	€ 29,50	317 90 065
		0,9 m	V	€ 8,40	€ 10,00	317 90 060
	F2G	5,0 m	V	€ 53,00	€ 63,05	317 90 027
		2,7 m	V	€ 28,60	€ 34,05	317 90 025
		0,9 m	V	€ 9,80	€ 11,65	317 90 020
	F4	2,7 m	SK	€ 26,50	€ 31,55	215 90 045
		0,9 m	SK	€ 9,10	€ 10,85	215 90 040
	F5	2,7 m	SK	€ 29,20	€ 34,75	215 90 055
		0,9 m	SK	€ 10,10	€ 12,00	215 90 050
	F9	2,7 m	SK	€ 26,50	€ 31,55	215 90 095
		0,9 m	SK	€ 9,10	€ 10,85	215 90 090
	F6	2,7 m	SK	€ 29,20	€ 34,75	215 90 065
		0,9 m	SK	€ 10,10	€ 12,00	215 90 060
	F2G	2,7 m	SK	€ 32,40	€ 38,55	215 90 025
		0,9 m	SK	€ 11,30	€ 13,45	215 90 020
	F4	2,7 m	T	€ 22,40	€ 26,65	21790045-T
	F5	2,7 m	T	€ 25,80	€ 30,70	21790055-T
	F9	2,7 m	T	€ 22,40	€ 26,65	21790095-T
	F6	2,7 m	T	€ 25,80	€ 30,70	21790065-T
	F2G	2,7 m	T	€ 29,70	€ 35,35	21790025-T
370	F4	5,0 m	V	€ 47,00	€ 55,95	317 70 047
		2,7 m	V	€ 25,70	€ 30,60	317 70 045
		1,0 m	V	€ 9,90	€ 11,80	317 70 041
		0,9 m	V	€ 8,90	€ 10,60	317 70 040
	F5	5,0 m	V	€ 52,50	€ 62,50	317 70 057
		2,7 m	V	€ 29,40	€ 35,00	317 70 055
		1,0 m	V	€ 10,90	€ 12,95	317 70 051
		0,9 m	V	€ 10,00	€ 11,90	317 70 050
	F9	5,0 m	V	€ 47,00	€ 55,95	317 70 097
		2,7 m	V	€ 25,70	€ 30,60	317 70 095
		1,0 m	V	€ 9,90	€ 11,80	317 70 091
		0,9 m	V	€ 8,90	€ 10,60	317 70 090
	F6	5,0 m	V	€ 52,50	€ 62,50	317 70 067
		2,7 m	V	€ 29,40	€ 35,00	317 70 065
		1,0 m	V	€ 10,90	€ 12,95	317 70 061
		0,9 m	V	€ 10,00	€ 11,90	317 70 060
	F2G	5,0 m	V	€ 60,50	€ 72,00	317 70 027
		2,7 m	V	€ 32,90	€ 39,15	317 70 025
		1,0 m	V	€ 12,40	€ 14,75	317 70 021
		0,9 m	V	€ 11,30	€ 13,45	317 70 020
	F4	2,7 m	SK	€ 30,00	€ 35,70	215 70 045
		1,0 m	SK	€ 11,50	€ 13,70	215 70 041
		0,9 m	SK	€ 10,50	€ 12,50	215 70 040
	F5	2,7 m	SK	€ 32,90	€ 39,15	215 70 055
		1,0 m	SK	€ 12,70	€ 15,10	215 70 051
		0,9 m	SK	€ 11,50	€ 13,70	215 70 050
	F9	2,7 m	SK	€ 30,00	€ 35,70	215 70 095
		1,0 m	SK	€ 11,50	€ 13,70	215 70 091
		0,9 m	SK	€ 10,50	€ 12,50	215 70 090
	F6	2,7 m	SK	€ 32,90	€ 39,15	215 70 065
		1,0 m	SK	€ 12,70	€ 15,10	215 70 061
		0,9 m	SK	€ 11,50	€ 13,70	215 70 060
	F2G	2,7 m	SK	€ 37,00	€ 44,05	215 70 025
		1,0 m	SK	€ 14,20	€ 16,90	215 70 021
		0,9 m	SK	€ 12,90	€ 15,35	215 70 020

Abschluss-, Einfass- und Rampenprofile / Edge Trims and Ramp Profiles

Artikel	Farben	Länge	Version	Preis/Stück	unit price	Bestell-Nr.
article	colour	length	version	exkl. MwSt.	inkl. MwSt.	order no.
	F4	2,7 m	T	€ 26,90	€ 32,00	21770045-T
	F5	2,7 m	T	€ 30,30	€ 36,05	21770055-T
	F9	2,7 m	T	€ 26,90	€ 32,00	21770095-T
	F6	2,7 m	T	€ 30,30	€ 36,05	21770065-T
	F2G	2,7 m	T	€ 33,90	€ 40,35	21770025-T
371	F4	5,0 m	V	€ 49,00	€ 58,30	317 71 047
		2,7 m	V	€ 26,50	€ 31,55	317 71 045
	F5	5,0 m	V	€ 56,00	€ 66,65	317 71 057
		2,7 m	V	€ 30,20	€ 35,95	317 71 055
	F9	5,0 m	V	€ 49,00	€ 58,30	317 71 097
		2,7 m	V	€ 26,50	€ 31,55	317 71 095
		0,9 m	V	€ 9,20	€ 10,95	317 71 090
	F6	5,0 m	V	€ 56,00	€ 66,65	317 71 067
		2,7 m	V	€ 30,20	€ 35,95	317 71 065
	F2G	5,0 m	V	€ 62,50	€ 74,40	317 71 027
		2,7 m	V	€ 33,80	€ 40,20	317 71 025
	F7	2,7 m	V	€ 87,20	€ 103,75	317 371 307 5
382	F4	5,0 m	V	€ 66,50	€ 79,15	317 82 047
		2,7 m	V	€ 35,90	€ 42,70	317 82 045
		1,0 m	V	€ 13,20	€ 15,70	317 82 041
		0,9 m	V	€ 12,10	€ 14,40	317 82 040
	F5	5,0 m	V	€ 72,00	€ 85,70	317 82 057
		2,7 m	V	€ 38,90	€ 46,30	317 82 055
		1,0 m	V	€ 14,40	€ 17,15	317 82 051
		0,9 m	V	€ 13,00	€ 15,45	317 82 050
	F9	5,0 m	V	€ 66,50	€ 79,15	317 82 097
		2,7 m	V	€ 35,90	€ 42,70	317 82 095
		1,0 m	V	€ 13,20	€ 15,70	317 82 091
		0,9 m	V	€ 12,10	€ 14,40	317 82 090
	F6	5,0 m	V	€ 72,00	€ 85,70	317 82 067
		2,7 m	V	€ 38,90	€ 46,30	317 82 065
		1,0 m	V	€ 14,40	€ 17,15	317 82 061
		0,9 m	V	€ 13,00	€ 15,45	317 82 060
	F2	5,0 m	V	€ 72,00	€ 85,70	317 82 027
		2,7 m	V	€ 38,90	€ 46,30	317 82 025
		1,0 m	V	€ 14,40	€ 17,15	317 82 021
		0,9 m	V	€ 13,00	€ 15,45	317 82 020
	F0	2,7 m	T	€ 33,10	€ 39,40	21782005-T
	F4	2,7 m	T	€ 36,40	€ 43,30	21782045-T
	F5	2,7 m	T	€ 39,50	€ 47,00	21782055-T
	F9	2,7 m	T	€ 36,40	€ 43,30	21782095-T
	F6	2,7 m	T	€ 39,50	€ 47,00	21782065-T
	F2	2,7 m	T	€ 39,50	€ 47,00	21782025-T
	H30	2,7 m	T	€ 45,10	€ 53,65	2173821305-T
	H31	2,7 m	T	€ 45,10	€ 53,65	2173821315-T
	H33	2,7 m	T	€ 45,10	€ 53,65	2173821335-T
	H34	2,7 m	T	€ 45,10	€ 53,65	2173821345-T
	H61	2,7 m	T	€ 45,10	€ 53,65	2173821615-T
	H62	2,7 m	T	€ 45,10	€ 53,65	2173821625-T
	H64	2,7 m	T	€ 45,10	€ 53,65	2173821645-T
	H65	2,7 m	T	€ 45,10	€ 53,65	2173821655-T
	H81	2,7 m	T	€ 45,10	€ 53,65	2173821815-T
383	F4	2,7 m	V	€ 39,70	€ 47,25	317 83 045
		0,9 m	V	€ 13,80	€ 16,40	317 83 040
	F5	2,7 m	V	€ 44,60	€ 53,05	317 83 055
		0,9 m	V	€ 15,40	€ 18,35	317 83 050
	F9	2,7 m	V	€ 39,70	€ 47,25	317 83 095
		0,9 m	V	€ 13,80	€ 16,40	317 83 090
	F6	2,7 m	V	€ 44,60	€ 53,05	317 83 065
		0,9 m	V	€ 15,40	€ 18,35	317 83 060
	F2	2,7 m	V	€ 44,60	€ 53,05	317 83 025
		0,9 m	V	€ 15,40	€ 18,35	317 83 020
355	F3	2,5 m	V	€ 19,30	€ 22,95	317 55 034
		1,0 m	V	€ 7,90	€ 9,40	317 55 031
	F4	5,0 m	V	€ 38,00	€ 45,20	317 55 047
		2,5 m	V	€ 19,30	€ 22,95	317 55 044
		1,0 m	V	€ 7,90	€ 9,40	317 55 041
	F5	5,0 m	V	€ 43,50	€ 51,75	317 55 057
		2,5 m	V	€ 22,00	€ 26,20	317 55 054
		1,0 m	V	€ 9,00	€ 10,70	317 55 051
	F9	5,0 m	V	€ 38,00	€ 45,20	317 55 097
		2,5 m	V	€ 19,30	€ 22,95	317 55 094
		1,0 m	V	€ 7,90	€ 9,40	317 55 091
	F6	5,0 m	V	€ 43,50	€ 51,75	317 55 067
		2,5 m	V	€ 22,00	€ 26,20	317 55 064
		1,0 m	V	€ 9,00	€ 10,70	317 55 061
	F2	5,0 m	V	€ 43,50	€ 51,75	317 55 027
		2,5 m	V	€ 22,00	€ 26,20	317 55 024
		1,0 m	V	€ 9,00	€ 10,70	317 55 021
	F15 RAL9016	2,5 m	V	€ 27,80	€ 33,10	217 355 715 4
	F16 RAL9005	2,5 m	V	€ 27,80	€ 33,10	217 355 701 4
356	F3	2,5 m	V	€ 19,50	€ 23,20	317 56 034
		1,0 m	V	€ 8,00	€ 9,50	317 56 031
	F4	5,0 m	V	€ 38,50	€ 45,80	317 56 047
		2,5 m	V	€ 19,50	€ 23,20	317 56 044

Artikel	Farben	Länge	Version	Preis/Stück	unit price	Bestell-Nr.
article	colour	length	version	exkl. MwSt.	inkl. MwSt.	order no.
		1,0 m	V	€ 8,00	€ 9,50	317 56 041
	F5	5,0 m	V	€ 44,00	€ 52,35	317 56 057
		2,5 m	V	€ 22,30	€ 26,55	317 56 054
		1,0 m	V	€ 9,10	€ 10,85	317 56 051
	F9	5,0 m	V	€ 38,50	€ 45,80	317 56 097
		2,5 m	V	€ 19,50	€ 23,20	317 56 094
		1,0 m	V	€ 8,00	€ 9,50	317 56 091
	F6	5,0 m	V	€ 44,00	€ 52,35	317 56 067
		2,5 m	V	€ 22,30	€ 26,55	317 56 064
		1,0 m	V	€ 9,10	€ 10,85	317 56 061
	F2	5,0 m	V	€ 44,00	€ 52,35	317 56 027
		2,5 m	V	€ 22,30	€ 26,55	317 56 024
		1,0 m	V	€ 9,10	€ 10,85	317 56 021
357	F3	2,5 m	V	€ 20,50	€ 24,40	317 57 034
		1,0 m	V	€ 8,40	€ 10,00	317 57 031
	F4	5,0 m	V	€ 40,50	€ 48,20	317 57 047
		2,5 m	V	€ 20,50	€ 24,40	317 57 044
		1,0 m	V	€ 8,40	€ 10,00	317 57 041
	F5	5,0 m	V	€ 46,00	€ 54,75	317 57 057
		2,5 m	V	€ 23,30	€ 27,75	317 57 054
		1,0 m	V	€ 9,50	€ 11,30	317 57 051
	F9	5,0 m	V	€ 40,50	€ 48,20	317 57 097
		2,5 m	V	€ 20,50	€ 24,40	317 57 094
		1,0 m	V	€ 8,40	€ 10,00	317 57 091
	F6	5,0 m	V	€ 46,00	€ 54,75	317 57 067
		2,5 m	V	€ 23,30	€ 27,75	317 57 064
		1,0 m	V	€ 9,50	€ 11,30	317 57 061
	F2	5,0 m	V	€ 46,00	€ 54,75	317 57 027
		2,5 m	V	€ 23,30	€ 27,75	317 57 024
		1,0 m	V	€ 9,50	€ 11,30	317 57 021
	F7	2,5 m	V	€ 48,00	€ 57,10	317 57 074
		1,0 m	V	€ 19,40	€ 23,10	317 57 071
358	F3	2,5 m	V	€ 21,30	€ 25,35	317 58 034
		1,0 m	V	€ 8,70	€ 10,35	317 58 031
	F4	5,0 m	V	€ 42,00	€ 50,00	317 58 047
		2,5 m	V	€ 21,30	€ 25,35	317 58 044
		1,0 m	V	€ 8,70	€ 10,35	317 58 041
	F5	5,0 m	V	€ 48,50	€ 57,70	317 58 057
		2,5 m	V	€ 24,50	€ 29,15	317 58 054
		1,0 m	V	€ 10,10	€ 12,00	317 58 051
	F9	5,0 m	V	€ 42,00	€ 50,00	317 58 097
		2,5 m	V	€ 21,30	€ 25,35	317 58 094
		1,0 m	V	€ 8,70	€ 10,35	317 58 091
	F6	5,0 m	V	€ 48,50	€ 57,70	317 58 067
		2,5 m	V	€ 24,50	€ 29,15	317 58 064
		1,0 m	V	€ 10,10	€ 12,00	317 58 061
	F2	5,0 m	V	€ 48,50	€ 57,70	317 58 027
		2,5 m	V	€ 24,50	€ 29,15	317 58 024
		1,0 m	V	€ 10,10	€ 12,00	317 58 021
359	F3	2,5 m	V	€ 21,50	€ 25,60	317 59 034
		1,0 m	V	€ 8,80	€ 10,45	317 59 031
	F4	5,0 m	V	€ 42,50	€ 50,60	317 59 047
		2,5 m	V	€ 21,50	€ 25,60	317 59 044
		1,0 m	V	€ 8,80	€ 10,45	317 59 041
	F5	5,0 m	V	€ 49,50	€ 58,90	317 59 057
		2,5 m	V	€ 25,00	€ 29,75	317 59 054
		1,0 m	V	€ 10,20	€ 12,15	317 59 051
	F9	5,0 m	V	€ 42,50	€ 50,60	317 59 097
		2,5 m	V	€ 21,50	€ 25,60	317 59 094
		1,0 m	V	€ 8,80	€ 10,45	317 59 091
	F6	5,0 m	V	€ 49,50	€ 58,90	317 59 067
		2,5 m	V	€ 25,00	€ 29,75	317 59 064
		1,0 m	V	€ 10,20	€ 12,15	317 59 061
	F2	5,0 m	V	€ 49,50	€ 58,90	317 59 027
		2,5 m	V	€ 25,00	€ 29,75	317 59 024
		1,0 m	V	€ 10,20	€ 12,15	317 59 021
	F7	2,5 m	V	€ 57,50	€ 68,45	317 59 074
		1,0 m	V	€ 23,30	€ 27,75	317 59 071
361/3	F3	2,5 m	V	€ 24,30	€ 28,90	317 61 034
	F4	5,0 m	V	€ 48,00	€ 57,10	317 61 047
		2,5 m	V	€ 24,30	€ 28,90	317 61 044
		1,0 m	V	€ 9,90	€ 11,80	317 61 041
	F5	5,0 m	V	€ 54,00	€ 64,25	317 61 057
		2,5 m	V	€ 27,30	€ 32,50	317 61 054
	F9	5,0 m	V	€ 48,00	€ 57,10	317 61 097
		2,5 m	V	€ 24,30	€ 28,90	317 61 094
	F6	5,0 m	V	€ 54,00	€ 64,25	317 61 067
		2,5 m	V	€ 27,30	€ 32,50	317 61 064
	F2	5,0 m	V	€ 54,00	€ 64,25	317 61 027
		2,5 m	V	€ 27,30	€ 32,50	317 61 024
		1,0 m	V	€ 11,20	€ 13,35	317 61 021
361/3,5	F7	2,5 m	V	€ 51,00	€ 60,70	317 61 074
		1,0 m	V	€ 20,70	€ 24,65	317 61 071
362	F4	5,0 m	V	€ 48,50	€ 57,70	317 62 047
		2,5 m	V	€ 24,50	€ 29,15	317 62 044

Artikel	Farben	Länge	Version	Preis/Stück	unit price	Bestell-Nr.
article	colour	length	version	exkl. MwSt.	inkl. MwSt.	order no.
		1,0 m	V	€ 10,10	€ 12,00	317 62 041
	F2	5,0 m	V	€ 55,00	€ 65,45	317 62 027
		2,5 m	V	€ 27,80	€ 33,10	317 62 024
		1,0 m	V	€ 11,30	€ 13,45	317 62 021
	F7	2,5 m	V	€ 76,30	€ 90,80	317 62 074
		1,0 m	V	€ 30,70	€ 36,55	317 62 071
341	F3	2,5 m	V	€ 22,00	€ 26,20	317 31 034
		1,0 m	V	€ 9,00	€ 10,70	317 31 031
	F4	5,0 m	V	€ 43,50	€ 51,75	317 31 047
		2,5 m	V	€ 22,00	€ 26,20	317 31 044
		1,0 m	V	€ 9,00	€ 10,70	317 31 041
	F5	5,0 m	V	€ 48,00	€ 57,10	317 31 057
		2,5 m	V	€ 24,30	€ 28,90	317 31 054
		1,0 m	V	€ 9,90	€ 11,80	317 31 051
	F9	5,0 m	V	€ 43,50	€ 51,75	317 31 097
		2,5 m	V	€ 22,00	€ 26,20	317 31 094
		1,0 m	V	€ 9,00	€ 10,70	317 31 091
	F6	5,0 m	V	€ 48,00	€ 57,10	317 31 067
		2,5 m	V	€ 24,30	€ 28,90	317 31 064
		1,0 m	V	€ 9,90	€ 11,80	317 31 061
	F2	5,0 m	V	€ 48,00	€ 57,10	317 31 027
		2,5 m	V	€ 24,30	€ 28,90	317 31 024
		1,0 m	V	€ 9,90	€ 11,80	317 31 021
342	F4	5,0 m	V	€ 44,00	€ 52,35	317 32 047
		2,5 m	V	€ 22,30	€ 26,55	317 32 044
	F5	5,0 m	V	€ 48,50	€ 57,70	317 32 057
		2,5 m	V	€ 24,50	€ 29,15	317 32 054
	F9	5,0 m	V	€ 44,00	€ 52,35	317 32 097
		2,5 m	V	€ 22,30	€ 26,55	317 32 094
	F6	5,0 m	V	€ 48,50	€ 57,70	317 32 067
		2,5 m	V	€ 24,50	€ 29,15	317 32 064
	F2	5,0 m	V	€ 48,50	€ 57,70	317 32 027
		2,5 m	V	€ 24,50	€ 29,15	317 32 024
	F7	2,5 m	V	€ 65,80	€ 78,30	317 32 074
364	F3	3,0 m	V	€ 30,90	€ 36,75	317 64 038
		1,0 m	V	€ 10,50	€ 12,50	317 64 031
	F4	3,0 m	V	€ 30,90	€ 36,75	317 64 048
		1,0 m	V	€ 10,50	€ 12,50	317 64 041
	F5	3,0 m	V	€ 34,20	€ 40,70	317 64 058
		1,0 m	V	€ 11,60	€ 13,80	317 64 051
	F9	3,0 m	V	€ 30,90	€ 36,75	317 64 098
		1,0 m	V	€ 10,50	€ 12,50	317 64 091
	F6	3,0 m	V	€ 34,20	€ 40,70	317 64 068
		1,0 m	V	€ 11,60	€ 13,80	317 64 061
	F2	3,0 m	V	€ 34,20	€ 40,70	317 64 028
		1,0 m	V	€ 11,60	€ 13,80	317 64 021
363	F4	2,7 m	V	€ 31,30	€ 37,25	317 363 004 5
	F5	2,7 m	V	€ 34,60	€ 41,15	317 363 005 5
	F9	2,7 m	V	€ 31,30	€ 37,25	317 363 009 5
	F6	2,7 m	V	€ 34,60	€ 41,15	317 363 006 5
	F2	2,7 m	V	€ 34,60	€ 41,15	317 363 002 5
365	F3	3,0 m	V	€ 34,80	€ 41,40	317 65 038
		1,0 m	V	€ 11,80	€ 14,05	317 65 031
	F4	3,0 m	V	€ 34,80	€ 41,40	317 65 048
		1,0 m	V	€ 11,80	€ 14,05	317 65 041
	F5	3,0 m	V	€ 38,40	€ 45,70	317 65 058
		1,0 m	V	€ 13,00	€ 15,45	317 65 051
	F9	3,0 m	V	€ 34,80	€ 41,40	317 65 098
		1,0 m	V	€ 11,80	€ 14,05	317 65 091
	F6	3,0 m	V	€ 38,40	€ 45,70	317 65 068
		1,0 m	V	€ 13,00	€ 15,45	317 65 061
	F2	3,0 m	V	€ 38,40	€ 45,70	317 65 028
		1,0 m	V	€ 13,00	€ 15,45	317 65 021
	F15 RAL9016	3,0 m	V	€ 45,30	€ 53,90	217 365 715 8
	F16 RAL9005	3,0 m	V	€ 45,30	€ 53,90	217 365 701 8
366	F3	2,7 m	V	€ 32,40	€ 38,55	317 66 035
	F4	2,7 m	V	€ 32,40	€ 38,55	317 66 045
	F5	2,7 m	V	€ 36,20	€ 43,10	317 66 055
	F9	2,7 m	V	€ 32,40	€ 38,55	317 66 095
	F6	2,7 m	V	€ 36,20	€ 43,10	317 66 065
	F2	2,7 m	V	€ 36,20	€ 43,10	317 66 025
368	F4	2,7 m	V	€ 32,90	€ 39,15	317 368 004 5
	F5	2,7 m	V	€ 37,30	€ 44,40	317 368 005 5
	F9	2,7 m	V	€ 32,90	€ 39,15	317 368 009 5
	F6	2,7 m	V	€ 37,30	€ 44,40	317 368 006 5
	F2	2,7 m	V	€ 37,30	€ 44,40	317 368 002 5
367	F3	2,7 m	V	€ 35,40	€ 42,15	317 67 035
	F4	2,7 m	V	€ 35,40	€ 42,15	317 67 045
	F5	2,7 m	V	€ 38,60	€ 45,95	317 67 055
	F9	2,7 m	V	€ 35,40	€ 42,15	317 67 095
	F6	2,7 m	V	€ 38,60	€ 45,95	317 67 065
	F2	2,7 m	V	€ 38,60	€ 45,95	317 67 025
369 SK	F4	2,7 m	SK	€ 31,30	€ 37,25	215 369 004 5
	F5	2,7 m	SK	€ 34,80	€ 41,40	215 369 005 5
	F9	2,7 m	SK	€ 31,30	€ 37,25	215 369 009 5
	F6	2,7 m	SK	€ 34,80	€ 41,40	215 369 006 5

Artikel	Farben	Länge	Version	Preis/Stück	unit price	Bestell-Nr.
article	colour	length	version	exkl. MwSt.	inkl. MwSt.	order no.
	F2	2,7 m	SK	€ 34,80	€ 41,40	215 369 002 5
	RAL9016	2,7 m	SK	€ 41,30	€ 49,15	215 369 715 5
		2,0 m	SK	€ 30,60	€ 36,40	215 369 715 3
	RAL7016	2,7 m	SK	€ 41,30	€ 49,15	215 369 702 5
	H20	2,7 m	SK	€ 41,90	€ 49,85	215 369 120 5
	H22	2,7 m	SK	€ 41,90	€ 49,85	215 369 122 5
	H30	2,7 m	SK	€ 41,90	€ 49,85	215 369 130 5
	H31	2,7 m	SK	€ 41,90	€ 49,85	215 369 131 5
	H33	2,7 m	SK	€ 41,90	€ 49,85	215 369 133 5
	H40	2,7 m	SK	€ 41,90	€ 49,85	215 369 140 5
	H61	2,7 m	SK	€ 41,90	€ 49,85	215 369 161 5
	H62	2,7 m	SK	€ 41,90	€ 49,85	215 369 162 5
	H63	2,7 m	SK	€ 41,90	€ 49,85	215 369 163 5
	H64	2,7 m	SK	€ 41,90	€ 49,85	215 369 164 5
	H80	2,7 m	SK	€ 41,90	€ 49,85	215 369 180 5
	H81	2,7 m	SK	€ 41,90	€ 49,85	215 369 181 5
	H95	2,7 m	SK	€ 41,90	€ 49,85	215 369 195 5
369 N/SK	F4	2,7 m	SK	€ 42,90	€ 51,05	2153690045-N
	F5	2,7 m	SK	€ 46,40	€ 55,20	2153690055-N
	F9	2,7 m	SK	€ 42,90	€ 51,05	2153690095-N
	F6	2,7 m	SK	€ 46,40	€ 55,20	2153690065-N
	F2	2,7 m	SK	€ 46,40	€ 55,20	2153690025-N
	F15 RAL9016	2,7 m	SK	€ 52,70	€ 62,70	2153697155-N
	RAL7016	2,7 m	SK	€ 52,70	€ 62,70	2153697025-N
238 N/SK	F4	2,7 m	SK	€ 30,80	€ 36,65	2152380045-N
	F5	2,7 m	SK	€ 33,50	€ 39,85	2152380055-N
	F9	2,7 m	SK	€ 30,80	€ 36,65	2152380095-N
	F6	2,7 m	SK	€ 33,50	€ 39,85	2152380065-N
	F2G	2,7 m	SK	€ 36,20	€ 43,10	2152380025-N
292	F4	2,7 m	V	€ 36,20	€ 43,10	319 92 045
	F5	2,7 m	V	€ 39,20	€ 46,65	319 92 055
	F9	2,7 m	V	€ 36,20	€ 43,10	319 92 095
	F6	2,7 m	V	€ 39,20	€ 46,65	319 92 065
	F2	2,7 m	V	€ 39,20	€ 46,65	319 92 025
292 R	F4	0,6x0,6 m	V	€ 161,10	€ 191,70	119 292 004 9
	F16 RAL9005	0,6x0,6 m	V	€ 169,35	€ 201,55	119 292 701 9
297	F4	2,7 m	V	€ 37,80	€ 45,00	317 297 004 5
	F2	2,7 m	V	€ 44,30	€ 52,70	317 297 002 5
297 R	F4	0,6x0,6 m	V	€ 169,20	€ 201,35	117 297 004 9
	F16 RAL9005	0,6x0,6 m	V	€ 177,85	€ 211,65	117 297 701 9
223	F7	2,7 m	V	€ 152,00	€ 180,90	319 23 075
294	F4	5,0 m	V	€ 66,00	€ 78,55	317 294 004 7
		2,5 m	V	€ 33,50	€ 39,85	317 294 004 4
	F2	5,0 m	V	€ 71,50	€ 85,10	317 294 002 7
		2,5 m	V	€ 36,30	€ 43,20	317 294 002 4
	F16 RAL9005	5,0 m	V	€ 86,50	€ 102,95	317 294 701 7
		2,5 m	V	€ 43,80	€ 52,10	317 294 701 4
345	F3	3,0 m	V	€ 28,60	€ 34,05	317 345 003 8
	F4	3,0 m	V	€ 28,60	€ 34,05	317 345 004 8
	F9	3,0 m	V	€ 28,60	€ 34,05	317 345 009 8
	F2G	3,0 m	V	€ 33,50	€ 39,85	317 345 002 8
	F16 RAL9005	3,0 m	V	€ 34,00	€ 40,45	317 345 701 8
346	F3	3,0 m	V	€ 34,30	€ 40,80	317 346 003 8
	F4	3,0 m	V	€ 34,30	€ 40,80	317 346 004 8
	F9	3,0 m	V	€ 34,30	€ 40,80	317 346 009 8
	F2G	3,0 m	V	€ 40,80	€ 48,55	317 346 002 8
801	F3	5,0 m	V	€ 53,50	€ 63,65	317 801 003 7
		2,5 m	V	€ 27,00	€ 32,15	317 801 003 4
	F4	5,0 m	V	€ 53,50	€ 63,65	317 801 004 7
		2,5 m	V	€ 27,00	€ 32,15	317 801 004 4
	F9	5,0 m	V	€ 53,50	€ 63,65	317 801 009 7
		2,5 m	V	€ 27,00	€ 32,15	317 801 009 4
	F2	5,0 m	V	€ 66,00	€ 78,55	317 801 002 7
		2,5 m	V	€ 33,30	€ 39,65	317 801 002 4
802						

Abschluss-, Einfass- und Rampenprofile / Edge Trims and Ramp Profiles

Artikel	Farben	Länge	Version	Preis/Stück	unit price	Bestell-Nr.
article	colour	length	version	exkl. MwSt.	inkl. MwSt.	order no.
F5		5,0 m	V	€ 57,50	€ 68,45	317 804 005 7
		2,5 m	V	€ 29,00	€ 34,50	317 804 005 4
		1,0 m	V	€ 11,80	€ 14,05	317 804 005 1
F9		5,0 m	V	€ 53,50	€ 63,65	317 804 009 7
		2,5 m	V	€ 27,00	€ 32,15	317 804 009 4
		1,0 m	V	€ 11,00	€ 13,10	317 804 009 1
F6		5,0 m	V	€ 57,50	€ 68,45	317 804 006 7
		2,5 m	V	€ 29,00	€ 34,50	317 804 006 4
		1,0 m	V	€ 11,80	€ 14,05	317 804 006 1
F2		5,0 m	V	€ 57,50	€ 68,45	317 804 002 7
		2,5 m	V	€ 29,00	€ 34,50	317 804 002 4
		1,0 m	V	€ 11,80	€ 14,05	317 804 002 1
806	F3	5,0 m	V	€ 54,00	€ 64,25	317 06 037
		2,5 m	V	€ 27,30	€ 32,50	317 06 034
		1,0 m	V	€ 11,30	€ 13,45	317 06 031
	F4	5,0 m	V	€ 54,00	€ 64,25	317 06 047
		2,5 m	V	€ 27,30	€ 32,50	317 06 044
		1,0 m	V	€ 11,30	€ 13,45	317 06 041
	F5	5,0 m	V	€ 59,00	€ 70,20	317 06 057
		2,5 m	V	€ 29,80	€ 35,45	317 06 054
		1,0 m	V	€ 12,40	€ 14,75	317 06 051
	F9	5,0 m	V	€ 54,00	€ 64,25	317 06 097
		2,5 m	V	€ 27,30	€ 32,50	317 06 094
		1,0 m	V	€ 11,30	€ 13,45	317 06 091
F6	5,0 m	V	€ 59,00	€ 70,20	317 06 067	
	2,5 m	V	€ 29,80	€ 35,45	317 06 064	
	1,0 m	V	€ 12,40	€ 14,75	317 06 061	
F2	5,0 m	V	€ 59,00	€ 70,20	317 06 027	
	2,5 m	V	€ 29,80	€ 35,45	317 06 024	
	1,0 m	V	€ 12,40	€ 14,75	317 06 021	
805	F3	5,0 m	V	€ 56,50	€ 67,25	317 05 037
		2,5 m	V	€ 28,50	€ 33,90	317 05 034
		1,0 m	V	€ 11,70	€ 13,90	317 05 031
	F4	5,0 m	V	€ 56,50	€ 67,25	317 05 047
		2,5 m	V	€ 28,50	€ 33,90	317 05 044
		1,0 m	V	€ 11,70	€ 13,90	317 05 041
	F5	5,0 m	V	€ 60,50	€ 72,00	317 05 057
		2,5 m	V	€ 30,50	€ 36,30	317 05 054
		1,0 m	V	€ 12,80	€ 15,25	317 05 051
	F9	5,0 m	V	€ 56,50	€ 67,25	317 05 097
		2,5 m	V	€ 28,50	€ 33,90	317 05 094
		1,0 m	V	€ 11,70	€ 13,90	317 05 091
F6	5,0 m	V	€ 60,50	€ 72,00	317 05 067	
	2,5 m	V	€ 30,50	€ 36,30	317 05 064	
	1,0 m	V	€ 12,80	€ 15,25	317 05 061	
F2	5,0 m	V	€ 60,50	€ 72,00	317 05 027	
	2,5 m	V	€ 30,50	€ 36,30	317 05 024	
	1,0 m	V	€ 12,80	€ 15,25	317 05 021	
011	F4	2,7 m	V	€ 23,50	€ 27,95	317 011 004 5
	F9	2,7 m	V	€ 23,50	€ 27,95	317 011 009 5
	F6	2,7 m	V	€ 27,00	€ 32,15	317 011 006 5
	F2	2,7 m	V	€ 27,00	€ 32,15	317 011 002 5
010	F4	2,7 m	V	€ 24,30	€ 28,90	317 010 004 5
	F9	2,7 m	V	€ 24,30	€ 28,90	317 010 009 5
	F6	2,7 m	V	€ 27,60	€ 32,85	317 010 006 5
	F2	2,7 m	V	€ 27,60	€ 32,85	317 010 002 5
012	F4	2,7 m	V	€ 25,20	€ 30,00	317 012 004 5
	F9	2,7 m	V	€ 25,20	€ 30,00	317 012 009 5
	F6	2,7 m	V	€ 28,40	€ 33,80	317 012 006 5
	F2	2,7 m	V	€ 28,40	€ 33,80	317 012 002 5
015	F4	2,7 m	V	€ 27,30	€ 32,50	317 015 004 5
	F9	2,7 m	V	€ 27,30	€ 32,50	317 015 009 5
	F6	2,7 m	V	€ 29,70	€ 35,35	317 015 006 5
	F2	2,7 m	V	€ 29,70	€ 35,35	317 015 002 5
211	F4	2,7 m	V	€ 26,20	€ 31,20	317 11 045
		0,9 m	V	€ 8,00	€ 9,50	317 11 040
	F5	2,7 m	V	€ 28,90	€ 34,40	317 11 055
		0,9 m	V	€ 8,90	€ 10,60	317 11 050
	F9	2,7 m	V	€ 26,20	€ 31,20	317 11 095
		0,9 m	V	€ 8,00	€ 9,50	317 11 090
	F6	2,7 m	V	€ 28,90	€ 34,40	317 11 065
		0,9 m	V	€ 8,90	€ 10,60	317 11 060
	F2	2,7 m	V	€ 28,90	€ 34,40	317 11 025
		0,9 m	V	€ 8,90	€ 10,60	317 11 020
	H20	2,7 m	V	€ 30,80	€ 36,65	211 11 205
	H22	0,9 m	V	€ 10,00	€ 11,90	211 11 200
		0,9 m	V	€ 10,00	€ 11,90	211 11 220
	H30	2,7 m	V	€ 30,80	€ 36,65	211 11 305
		0,9 m	V	€ 10,00	€ 11,90	211 11 300
	H31	2,7 m	V	€ 30,80	€ 36,65	211 11 315
		0,9 m	V	€ 10,00	€ 11,90	211 11 310
	H33	2,7 m	V	€ 30,80	€ 36,65	211 11 335
		0,9 m	V	€ 10,00	€ 11,90	211 11 330
	H40	2,7 m	V	€ 30,80	€ 36,65	211 11 405

Artikel	Farben	Länge	Version	Preis/Stück	unit price	Bestell-Nr.
article	colour	length	version	exkl. MwSt.	inkl. MwSt.	order no.
H61		0,9 m	V	€ 10,00	€ 11,90	211 11 400
		2,7 m	V	€ 30,80	€ 36,65	211 11 615
H62		0,9 m	V	€ 10,00	€ 11,90	211 11 610
		2,7 m	V	€ 30,80	€ 36,65	211 11 625
H63		0,9 m	V	€ 10,00	€ 11,90	211 11 620
		2,7 m	V	€ 30,80	€ 36,65	211 11 635
H64		0,9 m	V	€ 10,00	€ 11,90	211 11 630
		2,7 m	V	€ 30,80	€ 36,65	211 11 645
H81		0,9 m	V	€ 10,00	€ 11,90	211 11 640
		2,7 m	V	€ 30,80	€ 36,65	211 11 835
H95		0,9 m	V	€ 10,00	€ 11,90	211 11 830
		2,7 m	V	€ 30,80	€ 36,65	211 11 955
210	F4	0,9 m	V	€ 10,00	€ 11,90	211 11 950
		2,7 m	V	€ 27,80	€ 33,10	317 10 045
F5		0,9 m	V	€ 8,60	€ 10,25	317 10 040
		2,7 m	V	€ 31,30	€ 37,25	317 10 055
F9		0,9 m	V	€ 9,50	€ 11,30	317 10 050
		2,7 m	V	€ 27,80	€ 33,10	317 10 095
F6		0,9 m	V	€ 8,60	€ 10,25	317 10 090
		2,7 m	V	€ 31,30	€ 37,25	317 10 065
F2		0,9 m	V	€ 9,50	€ 11,30	317 10 060
		2,7 m	V	€ 31,30	€ 37,25	317 10 025
H20		0,9 m	V	€ 9,50	€ 11,30	317 10 020
		2,7 m	V	€ 31,90	€ 37,95	211 10 205
H22		0,9 m	V	€ 10,20	€ 12,15	211 10 200
		2,7 m	V	€ 31,90	€ 37,95	211 10 225
H30		0,9 m	V	€ 10,20	€ 12,15	211 10 220
		2,7 m	V	€ 31,90	€ 37,95	211 10 305
H31		0,9 m	V	€ 10,20	€ 12,15	211 10 300
		2,7 m	V	€ 31,90	€ 37,95	211 10 315
H33		0,9 m	V	€ 10,20	€ 12,15	211 10 310
		2,7 m	V	€ 31,90	€ 37,95	211 10 335
H40		0,9 m	V	€ 10,20	€ 12,15	211 10 330
		2,7 m	V	€ 31,90	€ 37,95	211 10 405
H61		0,9 m	V	€ 10,20	€ 12,15	211 10 400
		2,7 m	V	€ 31,90	€ 37,95	211 10 615
H62		0,9 m	V	€ 10,20	€ 12,15	211 10 610
		2,7 m	V	€ 31,90	€ 37,95	211 10 625
H63		0,9 m	V	€ 10,20	€ 12,15	211 10 620
		2,7 m	V	€ 31,90	€ 37,95	211 10 635
H64		0,9 m	V	€ 10,20	€ 12,15	211 10 630
		2,7 m	V	€ 31,90	€ 37,95	211 10 645
H80		0,9 m	V	€ 10,20	€ 12,15	211 10 640
		2,7 m	V	€ 31,90	€ 37,95	211 10 805
H81		0,9 m	V	€ 10,20	€ 12,15	211 10 800
		2,7 m	V	€ 31,90	€ 37,95	211 10 835
H95		0,9 m	V	€ 10,20	€ 12,15	211 10 830
		2,7 m	V	€ 31,90	€ 37,95	211 10 955
212	F4	0,9 m	V	€ 10,20	€ 12,15	211 10 950
		2,7 m	V	€ 28,60	€ 34,05	317 12 045
F5		0,9 m	V	€ 8,80	€ 10,45	317 12 040
		2,7 m	V	€ 31,90	€ 37,95	317 12 055
F9		0,9 m	V	€ 9,70	€ 11,55	317 12 050
		2,7 m	V	€ 28,60	€ 34,05	317 12 095
F6		0,9 m	V	€ 8,80	€ 10,45	317 12 090
		2,7 m	V	€ 31,90	€ 37,95	317 12 065
F2		0,9 m	V	€ 9,70	€ 11,55	317 12 060
		2,7 m	V	€ 31,90	€ 37,95	317 12 025
H20		0,9 m	V	€ 9,70	€ 11,55	317 12 020
		2,7 m	V	€ 33,50	€ 39,85	211 12 205
H22		0,9 m	V	€ 10,50	€ 12,50	211 12 200
		2,7 m	V	€ 33,50	€ 39,85	211 12 225
H30		0,9 m	V	€ 10,50	€ 12,50	211 12 220
		2,7 m	V	€ 33,50	€ 39,85	211 12 305
H31		0,9 m	V	€ 10,50	€ 12,50	211 12 300
		2,7 m	V	€ 33,50	€ 39,85	211 12 315
H33		0,9 m	V	€ 10,50	€ 12,50	211 12 310
		2,7 m	V	€ 33,50	€ 39,85	211 12 335
H40		0,9 m	V	€ 10,50	€ 12,50	211 12 330
		2,7 m	V	€ 33,50	€ 39,85	211 12 405
H61		0,9 m	V	€ 10,50	€ 12,50	211 12 400
		2,7 m	V	€ 33,50	€ 39,85	211 12 615
H62		0,9 m	V	€ 10,50	€ 12,50	211 12 610
		2,7 m	V	€ 33,50	€ 39,85	211 12 625
H63		0,9 m	V	€ 10,50	€ 12,50	211 12 620
		2,7 m	V	€ 33,50	€ 39,85	211 12 635
H64		0,9 m	V	€ 10,50	€ 12,50	211 12 630
		2,7 m	V	€ 33,50	€ 39,85	211 12 645
H80		0,9 m	V	€		

Artikel	Farben	Länge	Version	Preis/Stück	unit price	Bestell-Nr.
article	colour	length	version	exkl. MwSt.	inkl. MwSt.	order no.
213	F4	2,7 m	V	€ 30,50	€ 36,30	317 13 045
		0,9 m	V	€ 9,20	€ 10,95	317 13 040
	F5	2,7 m	V	€ 34,00	€ 40,45	317 13 055
		0,9 m	V	€ 10,30	€ 12,25	317 13 050
	F9	2,7 m	V	€ 30,50	€ 36,30	317 13 095
		0,9 m	V	€ 9,20	€ 10,95	317 13 090
	F6	2,7 m	V	€ 34,00	€ 40,45	317 13 065
		0,9 m	V	€ 10,30	€ 12,25	317 13 060
	F2	2,7 m	V	€ 34,00	€ 40,45	317 13 025
		0,9 m	V	€ 10,30	€ 12,25	317 13 020
	H20	2,7 m	V	€ 35,10	€ 41,75	211 13 205
		0,9 m	V	€ 11,20	€ 13,35	211 13 200
	H22	2,7 m	V	€ 35,10	€ 41,75	211 13 225
		0,9 m	V	€ 11,20	€ 13,35	211 13 220
	H30	2,7 m	V	€ 35,10	€ 41,75	211 13 305
		0,9 m	V	€ 11,20	€ 13,35	211 13 300
	H31	2,7 m	V	€ 35,10	€ 41,75	211 13 315
		0,9 m	V	€ 11,20	€ 13,35	211 13 310
	H33	2,7 m	V	€ 35,10	€ 41,75	211 13 335
		0,9 m	V	€ 11,20	€ 13,35	211 13 330
	H40	2,7 m	V	€ 35,10	€ 41,75	211 13 405
		0,9 m	V	€ 11,20	€ 13,35	211 13 400
	H61	2,7 m	V	€ 35,10	€ 41,75	211 13 615
		0,9 m	V	€ 11,20	€ 13,35	211 13 610
H62	2,7 m	V	€ 35,10	€ 41,75	211 13 625	
	0,9 m	V	€ 11,20	€ 13,35	211 13 620	
H63	2,7 m	V	€ 35,10	€ 41,75	211 13 635	
	0,9 m	V	€ 11,20	€ 13,35	211 13 630	
H64	2,7 m	V	€ 35,10	€ 41,75	211 13 645	
	0,9 m	V	€ 11,20	€ 13,35	211 13 640	
H80	2,7 m	V	€ 35,10	€ 41,75	211 13 805	
	0,9 m	V	€ 11,20	€ 13,35	211 13 800	
H81	2,7 m	V	€ 35,10	€ 41,75	211 13 835	
	0,9 m	V	€ 11,20	€ 13,35	211 13 830	
H95	2,7 m	V	€ 35,10	€ 41,75	211 13 955	
	0,9 m	V	€ 11,20	€ 13,35	211 13 950	
214	F4	2,7 m	V	€ 31,60	€ 37,60	317 14 045
		0,9 m	V	€ 9,50	€ 11,30	317 14 040
	F5	2,7 m	V	€ 35,10	€ 41,75	317 14 055
		0,9 m	V	€ 10,50	€ 12,50	317 14 050
	F9	2,7 m	V	€ 31,60	€ 37,60	317 14 095
		0,9 m	V	€ 9,50	€ 11,30	317 14 090
	F6	2,7 m	V	€ 35,10	€ 41,75	317 14 065
		0,9 m	V	€ 10,50	€ 12,50	317 14 060
	F2	2,7 m	V	€ 35,10	€ 41,75	317 14 025
		0,9 m	V	€ 10,50	€ 12,50	317 14 020
	H20	2,7 m	V	€ 35,90	€ 42,70	211 14 205
		0,9 m	V	€ 11,40	€ 13,55	211 14 200
	H22	2,7 m	V	€ 35,90	€ 42,70	211 14 225
		0,9 m	V	€ 11,40	€ 13,55	211 14 220
	H30	2,7 m	V	€ 35,90	€ 42,70	211 14 305
		0,9 m	V	€ 11,40	€ 13,55	211 14 300
	H31	2,7 m	V	€ 35,90	€ 42,70	211 14 315
		0,9 m	V	€ 11,40	€ 13,55	211 14 310
	H33	2,7 m	V	€ 35,90	€ 42,70	211 14 335
		0,9 m	V	€ 11,40	€ 13,55	211 14 330
	H40	2,7 m	V	€ 35,90	€ 42,70	211 14 405
		0,9 m	V	€ 11,40	€ 13,55	211 14 400
	H61	2,7 m	V	€ 35,90	€ 42,70	211 14 615
		0,9 m	V	€ 11,40	€ 13,55	211 14 610
H62	2,7 m	V	€ 35,90	€ 42,70	211 14 625	
	0,9 m	V	€ 11,40	€ 13,55	211 14 620	
H63	2,7 m	V	€ 35,90	€ 42,70	211 14 635	
	0,9 m	V	€ 11,40	€ 13,55	211 14 630	
H64	2,7 m	V	€ 35,90	€ 42,70	211 14 645	
	0,9 m	V	€ 11,40	€ 13,55	211 14 640	
H80	2,7 m	V	€ 35,90	€ 42,70	211 14 805	
	0,9 m	V	€ 11,40	€ 13,55	211 14 800	
H81	2,7 m	V	€ 35,90	€ 42,70	211 14 835	
	0,9 m	V	€ 11,40	€ 13,55	211 14 830	
H95	2,7 m	V	€ 35,90	€ 42,70	211 14 955	
	0,9 m	V	€ 11,40	€ 13,55	211 14 950	
215	F4	2,7 m	V	€ 31,90	€ 37,95	317 15 045
		0,9 m	V	€ 9,70	€ 11,55	317 15 040
	F5	2,7 m	V	€ 35,60	€ 42,35	317 15 055
		0,9 m	V	€ 10,70	€ 12,75	317 15 050
	F9	2,7 m	V	€ 31,90	€ 37,95	317 15 095
		0,9 m	V	€ 9,70	€ 11,55	317 15 090
	F6	2,7 m	V	€ 35,60	€ 42,35	317 15 065
		0,9 m	V	€ 10,70	€ 12,75	317 15 060
	F2	2,7 m	V	€ 35,60	€ 42,35	317 15 025
		0,9 m	V	€ 10,70	€ 12,75	317 15 020
	H20	2,7 m	V	€ 36,20	€ 43,10	211 15 205
		0,9 m	V	€ 11,50	€ 13,70	211 15 200
H22	2,7 m	V	€ 36,20	€ 43,10	211 15 225	

Artikel	Farben	Länge	Version	Preis/Stück	unit price	Bestell-Nr.
article	colour	length	version	exkl. MwSt.	inkl. MwSt.	order no.
	H30	0,9 m	V	€ 11,50	€ 13,70	211 15 220
		2,7 m	V	€ 36,20	€ 43,10	211 15 305
	H31	0,9 m	V	€ 11,50	€ 13,70	211 15 300
		2,7 m	V	€ 36,20	€ 43,10	211 15 315
	H33	0,9 m	V	€ 11,50	€ 13,70	211 15 310
		2,7 m	V	€ 36,20	€ 43,10	211 15 335
	H40	0,9 m	V	€ 11,50	€ 13,70	211 15 330
		2,7 m	V	€ 36,20	€ 43,10	211 15 405
	H61	0,9 m	V	€ 11,50	€ 13,70	211 15 400
		2,7 m	V	€ 36,20	€ 43,10	211 15 615
	H62	0,9 m	V	€ 11,50	€ 13,70	211 15 610
		2,7 m	V	€ 36,20	€ 43,10	211 15 625
	H63	0,9 m	V	€ 11,50	€ 13,70	211 15 620
		2,7 m	V	€ 36,20	€ 43,10	211 15 635
	H64	0,9 m	V	€ 11,50	€ 13,70	211 15 630
		2,7 m	V	€ 36,20	€ 43,10	211 15 645
	H80	0,9 m	V	€ 11,50	€ 13,70	211 15 640
		2,7 m	V	€ 36,20	€ 43,10	211 15 805
	H81	0,9 m	V	€ 11,50	€ 13,70	211 15 800
		2,7 m	V	€ 36,20	€ 43,10	211 15 835
	H95	0,9 m	V	€ 11,50	€ 13,70	211 15 830
		2,7 m	V	€ 36,20	€ 43,10	211 15 955
	H95	0,9 m	V	€ 11,50	€ 13,70	211 15 950
217	F4	2,7 m	V	€ 35,10	€ 41,75	317 17 045
		0,9 m	V	€ 10,80	€ 12,85	317 17 040
	F5	2,7 m	V	€ 38,60	€ 45,95	317 17 055
		0,9 m	V	€ 12,00	€ 14,30	317 17 050
	F9	2,7 m	V	€ 35,10	€ 41,75	317 17 095
		0,9 m	V	€ 10,80	€ 12,85	317 17 090
F6	2,7 m	V	€ 38,60	€ 45,95	317 17 065	
	0,9 m	V	€ 12,00	€ 14,30	317 17 060	
F2	2,7 m	V	€ 38,60	€ 45,95	317 17 025	
	0,9 m	V	€ 12,00	€ 14,30	317 17 020	
219	F4	2,7 m	V	€ 37,30	€ 44,40	317 19 045
		0,9 m	V	€ 11,60	€ 13,80	317 19 040
	F2	2,7 m	V	€ 41,60	€ 49,50	317 19 025
		0,9 m	V	€ 12,90	€ 15,35	317 19 020
192	F4	2,7 m	V	€ 28,90	€ 34,40	317 93 045
		F2G	2,7 m	V	€ 36,50	€ 43,45
196	F4	2,7 m	V	€ 31,90	€ 37,95	317 96 045
		F2G	2,7 m	V	€ 40,20	€ 47,85
200 U	F4	2,7 m	U	€ 39,40	€ 46,90	211 00 045
		0,9 m	U	€ 12,20	€ 14,50	211 00 040
	F5	2,7 m	U	€ 43,70	€ 52,00	211 00 055
		0,9 m	U	€ 13,40	€ 15,95	211 00 050
	F9	2,7 m	U	€ 39,40	€ 46,90	211 00 095
		0,9 m	U	€ 12,20	€ 14,50	211 00 090
	F6	2,7 m	U	€ 43,70	€ 52,00	211 00 065
		0,9 m	U	€ 13,40	€ 15,95	211 00 060
F2	2,7 m	U	€ 43,70	€ 52,00	211 00 025	
	0,9 m	U	€ 13,40	€ 15,95	211 00 020	
201 U	F4	2,7 m	U	€ 40,00	€ 47,60	211 01 045
		0,9 m	U	€ 12,40	€ 14,75	211 01 040
	F5	2,7 m	U	€ 44,30	€ 52,70	211 01 055
		0,9 m	U	€ 13,90	€ 16,55	211 01 050
	F9	2,7 m	U	€ 40,00	€ 47,60	211 01 095
		0,9 m	U	€ 12,40	€ 14,75	211 01 090
F6	2,7 m	U	€ 44,30	€ 52,70	211 01 065	
	0,9 m	U	€ 13,90	€ 16,55	211 01 060	
F2	2,7 m	U	€ 44,30	€ 52,70	211 01 025	
	0,9 m	U	€ 13,90	€ 16,55	211 01 020	
202 U	F4	2,7 m	U	€ 42,70	€ 50,80	211 02 045
		0,9 m	U	€ 13,00	€ 15,45	211 02 040
	F5	2,7 m	U	€ 47,30	€ 56,30	211 02 055
		F9	2,7 m	U	€ 42,70	€ 50,80
	F6	2,7 m	U	€ 47,30	€ 56,30	211 02 065
		F2	2,7 m	U	€ 47,30	€ 56,30
		0,9 m	U	€ 14,50	€ 17,25	211 02 020
203 U	F4	2,7 m	U	€ 43,50	€ 51,75	211 03 045
		0,9 m	U	€ 13,30	€ 15,85	211 03 040
	F5	2,7 m	U	€ 48,30	€ 57,50	211 03 055
		F9	2,7 m	U	€ 43,50	€ 51,75
	F6	2,7 m	U	€ 48,30	€ 57,50	211 03 065
		F2	2,7 m	U	€ 48,30	€ 57,50
		0,9 m	U	€ 14,70	€ 17,50	211 03 020
204 U	F4	2,7 m	U	€ 43,70	€ 52,00	211 04 045
		0,9 m	U	€ 13,40	€ 15,95	211 04 040
	F5	2,7 m	U	€ 48,60	€ 57,85	211 04 055
		0,9 m	U	€ 14,80	€ 17,60	211 04 050
	F9	2,7 m	U			

Artikel	Farben	Länge	Version	Preis/Stück	unit price	Bestell-Nr.
article	colour	length	version	exkl. MwSt.	inkl. MwSt.	order no.
221	F4	2,7 m	V	€ 40,80	€ 48,55	317 221 004 5
		0,9 m	V	€ 12,60	€ 15,00	317 221 004 0
	F6	2,7 m	V	€ 45,90	€ 54,60	317 221 006 5
		0,9 m	V	€ 14,40	€ 17,15	317 221 006 0
	F2	2,7 m	V	€ 45,90	€ 54,60	317 221 002 5
		0,9 m	V	€ 14,40	€ 17,15	317 221 002 0
222	F4	2,7 m	V	€ 42,90	€ 51,05	317 222 004 5
		0,9 m	V	€ 13,20	€ 15,70	317 222 004 0
	F6	2,7 m	V	€ 48,30	€ 57,50	317 222 006 5
		0,9 m	V	€ 14,90	€ 17,75	317 222 006 0
	F2	2,7 m	V	€ 48,30	€ 57,50	317 222 002 5
		0,9 m	V	€ 14,90	€ 17,75	317 222 002 0

Rampenprofile
Ramp Profiles

260	F4	2,7 m	V	€ 97,20	€ 115,65	317 60 045	
	F5	2,7 m	V	€ 103,40	€ 123,05	317 60 055	
	F9	2,7 m	V	€ 97,20	€ 115,65	317 60 095	
	F6	2,7 m	V	€ 103,40	€ 123,05	317 60 065	
	F2	2,7 m	V	€ 103,40	€ 123,05	317 60 025	
268	F4	2,7 m	V	€ 97,20	€ 115,65	317 268 004 5	
	F5	2,7 m	V	€ 103,40	€ 123,05	317 268 005 5	
	F9	2,7 m	V	€ 97,20	€ 115,65	317 268 009 5	
	F6	2,7 m	V	€ 103,40	€ 123,05	317 268 006 5	
	F2	2,7 m	V	€ 103,40	€ 123,05	317 268 002 5	
	330	F3	2,7 m	V	€ 30,50	€ 36,30	317 330 003 5
F4		2,7 m	V	€ 30,50	€ 36,30	317 330 004 5	
F5		2,7 m	V	€ 34,00	€ 40,45	317 330 005 5	
F9		2,7 m	V	€ 30,50	€ 36,30	317 330 009 5	
F6		2,7 m	V	€ 34,00	€ 40,45	317 330 006 5	
F2		2,7 m	V	€ 34,00	€ 40,45	317 330 002 5	
332	F3	2,7 m	V	€ 47,30	€ 56,30	317 332 003 5	
	F4	2,7 m	V	€ 47,30	€ 56,30	317 332 004 5	
	F9	2,7 m	V	€ 47,30	€ 56,30	317 332 009 5	
	F2	2,7 m	V	€ 52,70	€ 62,70	317 332 002 5	
	264	F4	2,7 m	V	€ 30,00	€ 35,70	317 264 004 5
		0,9 m	V	€ 10,40	€ 12,40	317 264 004 0	
F5		2,7 m	V	€ 32,40	€ 38,55	317 264 005 5	
F9		2,7 m	V	€ 30,00	€ 35,70	317 264 009 5	
		0,9 m	V	€ 10,40	€ 12,40	317 264 009 0	
F6		2,7 m	V	€ 32,40	€ 38,55	317 264 006 5	
F2		2,7 m	V	€ 32,40	€ 38,55	317 264 002 5	
		0,9 m	V	€ 11,20	€ 13,35	317 264 002 0	
F4		2,7 m	U	€ 27,30	€ 32,50	211 264 004 5	
F5		2,7 m	U	€ 29,70	€ 35,35	211 264 005 5	
F9		2,7 m	U	€ 27,30	€ 32,50	211 264 009 5	
F6		2,7 m	U	€ 29,70	€ 35,35	211 264 006 5	
F2	2,7 m	U	€ 29,70	€ 35,35	211 264 002 5		
265	F4	2,7 m	V	€ 42,10	€ 50,10	317 265 004 5	
	F5	2,7 m	V	€ 45,40	€ 54,05	317 265 005 5	
	F9	2,7 m	V	€ 42,10	€ 50,10	317 265 009 5	
	F6	2,7 m	V	€ 45,40	€ 54,05	317 265 006 5	
	F2	2,7 m	V	€ 45,40	€ 54,05	317 265 002 5	
	F4	2,7 m	U	€ 39,20	€ 46,65	211 265 004 5	
	F5	2,7 m	U	€ 42,70	€ 50,80	211 265 005 5	
	F9	2,7 m	U	€ 39,20	€ 46,65	211 265 009 5	
	F6	2,7 m	U	€ 42,70	€ 50,80	211 265 006 5	
	F2	2,7 m	U	€ 42,70	€ 50,80	211 265 002 5	
	269 U	F4	3,0 m	U	€ 82,80	€ 98,55	211 269 004 8
	269 EC	F4	0,2 m	U	€ 69,90	€ 83,20	211 269 034 9
270-N U	F4	3,15 m	U	€ 93,90	€ 111,75	2112700048-N	
270-NEC	F4	0,2 m	U	€ 71,65	€ 85,25	2112700349-N	
270-N UDF	F4	3,15 m	U	€ 110,30	€ 131,25	2112709048-N	
270-NECD	F4	0,2 m	U	€ 75,30	€ 89,60	2112709349-N	
262 U	F4	3,15 m	U	€ 96,10	€ 114,35	211 262 004 8	
262 EC	F4	0,2 m	U	€ 73,60	€ 87,60	211 262 034 9	
262 U D	F4	3,15 m	U	€ 112,10	€ 133,40	211 262 904 8	
262 ECD	F4	0,2 m	U	€ 77,25	€ 91,95	211 262 934 9	
261 U	F4	3,0 m	U	€ 92,70	€ 110,30	211 261 004 8	
261 EC	F4	0,2 m	U	€ 74,20	€ 88,30	211 261 034 9	
263 U	F4	3,0 m	U	€ 105,30	€ 125,30	211 263 004 8	
263 EC	F4	0,2 m	U	€ 76,95	€ 91,55	211 263 034 9	
267 U	F4	3,0 m	U	€ 120,60	€ 143,50	211 267 004 8	
267 EC	F4	0,2 m	U	€ 79,75	€ 94,90	211 267 034 9	
266 U	F4	3,15 m	U	€ 163,20	€ 194,20	211 266 004 8	
266 EC	F4	0,2 m	U	€ 87,90	€ 104,60	211 266 034 9	



Treppenkanten- und Winkelprofile
Stair Nosings and Angle Edges

Artikel	Farben	Länge	Version	Preis/Stück	unit price	Bestell-Nr.
article	colour	length	version	exkl. MwSt.	inkl. MwSt.	order no.
236	F3	5,0 m	V	€ 45,00	€ 53,55	316 36 037
		3,0 m	V	€ 27,00	€ 32,15	316 36 038
		2,7 m	V	€ 24,30	€ 28,90	316 36 035
		2,5 m	V	€ 22,80	€ 27,15	316 36 034
		1,0 m	V	€ 9,80	€ 11,65	316 36 031
		0,9 m	V	€ 8,90	€ 10,60	316 36 030
	F4	5,0 m	V	€ 45,00	€ 53,55	316 36 047
		3,0 m	V	€ 27,00	€ 32,15	316 36 048
		2,7 m	V	€ 24,30	€ 28,90	316 36 045
		2,5 m	V	€ 22,80	€ 27,15	316 36 044
		1,0 m	V	€ 9,80	€ 11,65	316 36 041
		0,9 m	V	€ 8,90	€ 10,60	316 36 040
	F4G	3,0 m	V	€ 40,80	€ 48,55	316 236 804 8
		1,0 m	V	€ 14,20	€ 16,90	316 236 804 1
		F5	5,0 m	V	€ 50,00	€ 59,50
	F5	3,0 m	V	€ 30,00	€ 35,70	316 36 058
		2,7 m	V	€ 27,00	€ 32,15	316 36 055
		2,5 m	V	€ 25,30	€ 30,10	316 36 054
		1,0 m	V	€ 10,60	€ 12,60	316 36 051
		0,9 m	V	€ 9,90	€ 11,80	316 36 050
		F9	5,0 m	V	€ 45,00	€ 53,55
	3,0 m		V	€ 27,00	€ 32,15	316 36 098
	2,7 m		V	€ 24,30	€ 28,90	316 36 095
	2,5 m		V	€ 22,80	€ 27,15	316 36 094
	1,0 m		V	€ 9,80	€ 11,65	316 36 091
	0,9 m		V	€ 8,90	€ 10,60	316 36 090
	F6	5,0 m	V	€ 50,00	€ 59,50	316 36 067
		3,0 m	V	€ 30,00	€ 35,70	316 36 068
		2,7 m	V	€ 27,00	€ 32,15	316 36 065
		2,5 m	V	€ 25,30	€ 30,10	316 36 064
1,0 m		V	€ 10,60	€ 12,60	316 36 061	
0,9 m		V	€ 9,90	€ 11,80	316 36 060	
F2	5,0 m	V	€ 50,00	€ 59,50	316 36 027	
	3,0 m	V	€ 30,00	€ 35,70	316 36 028	
	2,7 m	V	€ 27,00	€ 32,15	316 36 025	
	2,5 m	V	€ 25,30	€ 30,10	316 36 024	
	1,0 m	V	€ 10,60	€ 12,60	316 36 021	
	0,9 m	V	€ 9,90	€ 11,80	316 36 020	
F1G	3,0 m	V	€ 43,50	€ 51,75	316 236 801 8	
	1,0 m	V	€ 15,10	€ 17,95	316 236 801 1	
	F3	5,0 m	SK	€ 50,00	€ 59,50	215 36 037
3,0 m		SK	€ 30,00	€ 35,70	215 36 038	
2,7 m		SK	€ 27,00	€ 32,15	215 36 035	
2,5 m		SK	€ 25,30	€ 30,10	215 36 034	
1,0 m		SK	€ 10,20	€ 12,15	215 36 031	
0,9 m		SK	€ 9,20	€ 10,95	215 36 030	
F4	5,0 m	SK	€ 50,00	€ 59,50	215 36 047	
	3,0 m	SK	€ 30,00	€ 35,70	215 36 048	
	2,7 m	SK	€ 27,00	€ 32,15	215 36 045	
	2,5 m	SK	€ 25,30	€ 30,10	215 36 044	
	1,0 m	SK	€ 10,20	€ 12,15	215 36 041	
	0,9 m	SK	€ 9,20	€ 10,95	215 36 040	
F4G	3,0 m	SK	€ 43,80	€ 52,10	215 236 804 8	
	1,0 m	SK	€ 15,20	€ 18,10	215 236 804 1	
	F5	5,0 m	SK	€ 55,00	€ 65,45	215 36 057
		3,0 m	SK	€ 33,00	€ 39,25	215 36 058
		2,7 m	SK	€ 29,70	€ 35,35	215 36 055
	F9	2,5 m	SK	€ 27,50	€ 32,75	215 36 054
1,0 m		SK	€ 11,20	€ 13,35	215 36 051	
0,9 m		SK	€ 10,20	€ 12,15	215 36 050	
5,0 m		SK	€ 50,00	€ 59,50	215 36 097	
3,0 m		SK	€ 30,00	€ 35,70	215 36 098	
2,7 m		SK	€ 27,00	€ 32,15	215 36 095	
F9	2,5 m	SK	€ 25,30	€ 30,10	215 36 094	
	1,0 m	SK	€ 10,20	€ 12,15	215 36 091	
	0,9 m	SK	€ 9,20	€ 10,95	215 36 090	

Treppenkanten- und Winkelprofile / Stair Nosings and Angle Edges

Artikel	Farben	Länge	Version	Preis/Stück	unit price	Bestell-Nr.	Artikel	Farben	Länge	Version	Preis/Stück	unit price	Bestell-Nr.
article	colour	length	version	exkl. MwSt.	inkl. MwSt.	order no.	article	colour	length	version	exkl. MwSt.	inkl. MwSt.	order no.
F6		5,0 m	SK	€ 55,00	€ 65,45	215 36 067	F9		5,0 m	V	€ 49,50	€ 58,90	316 35 097
		3,0 m	SK	€ 33,00	€ 39,25	215 36 068			3,0 m	V	€ 29,70	€ 35,35	316 35 098
		2,7 m	SK	€ 29,70	€ 35,35	215 36 065			2,7 m	V	€ 26,70	€ 31,75	316 35 095
		2,5 m	SK	€ 27,80	€ 33,10	215 36 064			2,5 m	V	€ 25,00	€ 29,75	316 35 094
		1,0 m	SK	€ 11,20	€ 13,35	215 36 061			1,0 m	V	€ 10,50	€ 12,50	316 35 091
F2		0,9 m	SK	€ 10,20	€ 12,15	215 36 060	0,9 m	V	€ 9,80	€ 11,65	316 35 090		
		5,0 m	SK	€ 55,00	€ 65,45	215 36 027	F6	5,0 m	V	€ 56,50	€ 67,25	316 35 067	
		3,0 m	SK	€ 33,00	€ 39,25	215 36 028	3,0 m	V	€ 33,90	€ 40,35	316 35 068		
		2,7 m	SK	€ 29,70	€ 35,35	215 36 025	2,7 m	V	€ 30,50	€ 36,30	316 35 065		
		2,5 m	SK	€ 27,80	€ 33,10	215 36 024	2,5 m	V	€ 28,50	€ 33,90	316 35 064		
F1G		1,0 m	SK	€ 11,20	€ 13,35	215 36 021	1,0 m	V	€ 11,70	€ 13,90	316 35 061		
		0,9 m	SK	€ 10,20	€ 12,15	215 36 020	0,9 m	V	€ 10,80	€ 12,85	316 35 060		
		3,0 m	SK	€ 46,80	€ 55,70	215 236 802 8	F2	5,0 m	V	€ 56,50	€ 67,25	316 35 027	
		1,0 m	SK	€ 16,20	€ 19,30	215 236 801 1	3,0 m	V	€ 33,90	€ 40,35	316 35 028		
		2,7 m	V	€ 30,50	€ 36,30	316 35 025	2,7 m	V	€ 28,50	€ 33,90	316 35 024		
RAL9016		1,0 m	SK	€ 12,40	€ 14,75	215 236 715 1	1,0 m	V	€ 11,70	€ 13,90	316 35 021		
		0,9 m	SK	€ 11,20	€ 13,35	215 236 715 0	0,9 m	V	€ 10,80	€ 12,85	316 35 020		
		3,0 m	SK	€ 36,60	€ 43,55	215 236 701 8	F1G	3,0 m	V	€ 47,70	€ 56,75	316 235 801 8	
		2,7 m	SK	€ 32,90	€ 39,15	215 236 701 5	1,0 m	V	€ 16,50	€ 19,65	316 235 801 1		
		1,0 m	SK	€ 12,40	€ 14,75	215 236 701 1	F3	5,0 m	SK	€ 54,50	€ 64,85	215 35 037	
RAL9005		0,9 m	SK	€ 11,20	€ 13,35	215 236 701 0	3,0 m	SK	€ 32,70	€ 38,90	215 35 038		
		2,7 m	SK	€ 34,30	€ 40,80	215 36 205	2,7 m	SK	€ 29,40	€ 35,00	215 35 035		
		1,0 m	SK	€ 13,20	€ 15,70	215 36 201	2,5 m	SK	€ 27,50	€ 32,75	215 35 034		
		0,9 m	SK	€ 12,10	€ 14,40	215 36 200	1,0 m	SK	€ 11,10	€ 13,20	215 35 031		
		0,9 m	SK	€ 12,10	€ 14,40	215 36 225	0,9 m	SK	€ 10,10	€ 12,00	215 35 030		
H20		2,7 m	SK	€ 34,30	€ 40,80	215 36 221	F4	5,0 m	SK	€ 54,50	€ 64,85	215 35 047	
		1,0 m	SK	€ 13,20	€ 15,70	215 36 221	3,0 m	SK	€ 32,70	€ 38,90	215 35 048		
		0,9 m	SK	€ 12,10	€ 14,40	215 36 305	2,7 m	SK	€ 29,40	€ 35,00	215 35 045		
		2,7 m	SK	€ 34,30	€ 40,80	215 36 305	2,5 m	SK	€ 27,50	€ 32,75	215 35 044		
		1,0 m	SK	€ 13,20	€ 15,70	215 36 301	1,0 m	SK	€ 11,10	€ 13,20	215 35 041		
H30		0,9 m	SK	€ 12,10	€ 14,40	215 36 300	0,9 m	SK	€ 10,10	€ 12,00	215 35 040		
		2,7 m	SK	€ 34,30	€ 40,80	215 36 315	F4G	3,0 m	SK	€ 46,30	€ 55,10	215 235 804 8	
		1,0 m	SK	€ 13,20	€ 15,70	215 36 311	1,0 m	SK	€ 16,30	€ 19,40	215 235 804 1		
		0,9 m	SK	€ 12,10	€ 14,40	215 36 310	F5	5,0 m	SK	€ 60,50	€ 72,00	215 35 057	
		2,7 m	SK	€ 34,30	€ 40,80	215 36 335	3,0 m	SK	€ 36,30	€ 43,20	215 35 058		
H31		0,9 m	SK	€ 12,10	€ 14,40	215 36 330	2,7 m	SK	€ 32,70	€ 38,90	215 35 055		
		2,7 m	SK	€ 34,30	€ 40,80	215 36 405	2,5 m	SK	€ 30,50	€ 36,30	215 35 054		
		1,0 m	SK	€ 13,20	€ 15,70	215 36 401	1,0 m	SK	€ 12,20	€ 14,50	215 35 051		
		0,9 m	SK	€ 12,10	€ 14,40	215 36 400	0,9 m	SK	€ 11,20	€ 13,35	215 35 050		
		2,7 m	SK	€ 34,30	€ 40,80	215 36 615	F9	5,0 m	SK	€ 54,50	€ 64,85	215 35 097	
H61		1,0 m	SK	€ 13,20	€ 15,70	215 36 611	3,0 m	SK	€ 32,70	€ 38,90	215 35 098		
		0,9 m	SK	€ 12,10	€ 14,40	215 36 610	2,7 m	SK	€ 29,40	€ 35,00	215 35 095		
		2,7 m	SK	€ 34,30	€ 40,80	215 36 625	2,5 m	SK	€ 27,50	€ 32,75	215 35 094		
		1,0 m	SK	€ 13,20	€ 15,70	215 36 621	1,0 m	SK	€ 11,10	€ 13,20	215 35 091		
		0,9 m	SK	€ 12,10	€ 14,40	215 36 620	0,9 m	SK	€ 10,10	€ 12,00	215 35 090		
H62		2,7 m	SK	€ 34,30	€ 40,80	215 36 635	F6	5,0 m	SK	€ 60,50	€ 72,00	215 35 067	
		1,0 m	SK	€ 13,20	€ 15,70	215 36 631	3,0 m	SK	€ 36,30	€ 43,20	215 35 068		
		0,9 m	SK	€ 12,10	€ 14,40	215 36 630	2,7 m	SK	€ 32,70	€ 38,90	215 35 065		
		2,7 m	SK	€ 34,30	€ 40,80	215 36 645	2,5 m	SK	€ 30,50	€ 36,30	215 35 064		
		1,0 m	SK	€ 13,20	€ 15,70	215 36 641	1,0 m	SK	€ 12,20	€ 14,50	215 35 061		
H63		0,9 m	SK	€ 12,10	€ 14,40	215 36 640	0,9 m	SK	€ 11,20	€ 13,35	215 35 060		
		2,7 m	SK	€ 34,30	€ 40,80	215 36 655	F2	5,0 m	SK	€ 60,50	€ 72,00	215 35 027	
		1,0 m	SK	€ 13,20	€ 15,70	215 36 651	3,0 m	SK	€ 36,30	€ 43,20	215 35 028		
		0,9 m	SK	€ 12,10	€ 14,40	215 36 650	2,7 m	SK	€ 32,70	€ 38,90	215 35 025		
		2,7 m	SK	€ 34,30	€ 40,80	215 36 805	2,5 m	SK	€ 30,50	€ 36,30	215 35 024		
H64		1,0 m	SK	€ 13,20	€ 15,70	215 36 801	1,0 m	SK	€ 12,20	€ 14,50	215 35 021		
		0,9 m	SK	€ 12,10	€ 14,40	215 36 800	0,9 m	SK	€ 11,20	€ 13,35	215 35 020		
		2,7 m	SK	€ 34,30	€ 40,80	215 36 835	F1G	5,0 m	SK	€ 59,60	€ 71,10	215 235 801 8	
		1,0 m	SK	€ 13,20	€ 15,70	215 36 831	1,0 m	SK	€ 17,40	€ 20,70	215 235 801 1		
		0,9 m	SK	€ 12,10	€ 14,40	215 36 830	F15 RAL9016	5,0 m	SK	€ 68,00	€ 80,90	215 235 715 7	
H80		2,7 m	SK	€ 34,30	€ 40,80	215 36 955	3,0 m	SK	€ 40,80	€ 48,55	215 235 715 8		
		1,0 m	SK	€ 13,20	€ 15,70	215 36 951	2,7 m	SK	€ 36,70	€ 43,65	215 235 715 5		
		0,9 m	SK	€ 12,10	€ 14,40	215 36 950	1,0 m	SK	€ 13,70	€ 16,30	215 235 715 1		
		2,7 m	SK	€ 34,30	€ 40,80	316 35 037	F16 RAL9005	3,0 m	SK	€ 40,80	€ 48,55	215 235 701 8	
		1,0 m	SK	€ 13,20	€ 15,70	316 35 038	1,0 m	SK	€ 13,70	€ 16,30	215 235 701 1		
235 F3		3,0 m	V	€ 29,70	€ 35,35	316 35 035	H20	2,7 m	SK	€ 37,50	€ 44,65	215 35 205	
		2,7 m	V	€ 26,70	€ 31,75	316 35 035	1,0 m	SK	€ 14,30	€ 17,00	215 35 201		
		2,5 m	V	€ 25,00	€ 29,75	316 35 034	0,9 m	SK	€ 13,30	€ 15,85	215 35 200		
		1,0 m	V	€ 10,50	€ 12,50	316 35 031	H22	2,7 m	SK	€ 37,50	€ 44,65	215 35 225	
		0,9 m	V	€ 9,80	€ 11,65	316 35 030	1,0 m	SK	€ 14,30	€ 17,00	215 35 221		
F4		3,0 m	V	€ 29,70	€ 35,35	316 35 048	0,9 m	SK	€ 13,30	€ 15,85	215 35 220		
		2,7 m	V	€ 26,70	€ 31,75	316 35 045	H30	2,7 m	SK	€ 37,50	€ 44,65	215 35 305	
		2,5 m	V	€ 25,00	€ 29,75	316 35 044	1,0 m	SK	€ 14,30	€ 17,00	215 35 301		
		1,0 m	V	€ 10,50	€ 12,50	316 35 041	0,9 m	SK	€ 13,30	€ 15,85	215 35 300		
		0,9 m	V	€ 9,80	€ 11,65	316 35 040	H31	2,7 m	SK	€ 37,50	€ 44,65	215 35 315	
F4G		3,0 m	V	€ 44,70	€ 53,20	316 235 804 8	1,0 m	SK	€ 14,30	€ 17,00	215 35 311		
		1,0 m	V	€ 15,50	€ 18,45	316 235 804 1	0,9 m	SK	€ 13,30	€ 15,85	215 35 310		
		5,0 m	V	€ 56,50	€ 67,25	316 35 057	H33	2,7 m	SK	€ 37,50	€ 44,65	215 35 335	
		3,0 m	V	€ 33,90	€ 40,35	316 35 058	1,0 m	SK	€ 14,30	€ 17,00	215 35 331		
		2,7 m	V	€ 30,50	€ 36,30	316 35 055	0,9 m	SK	€ 13,30	€ 15,85	215 35 330		
F5		2,5 m	V	€ 28,50	€ 33,90	316 35 054	H40	2,7 m	SK	€ 37,50	€ 44,65	215 35 405	
		1,0 m	V	€ 11,70	€ 13,90	316 35 051	1,0 m	SK	€ 14,30	€ 17,00	215 35 401		
		0,9 m	V	€ 10,80	€ 12,85	316 35 050	0,9 m	SK	€ 13,30	€ 15,85	215 35 400		

Treppenkanten- und Winkelprofile / Stair Nosings and Angle Edges

Artikel	Farben	Länge	Version	Preis/Stück	unit price	Bestell-Nr.	
article	colour	length	version	exkl. MwSt.	inkl. MwSt.	order no.	
H61		2,7 m	SK	€ 37,50	€ 44,65	215 35 615	
		1,0 m	SK	€ 14,30	€ 17,00	215 35 611	
		0,9 m	SK	€ 13,30	€ 15,85	215 35 610	
H62		2,7 m	SK	€ 37,50	€ 44,65	215 35 625	
		1,0 m	SK	€ 14,30	€ 17,00	215 35 621	
		0,9 m	SK	€ 13,30	€ 15,85	215 35 620	
H63		2,7 m	SK	€ 37,50	€ 44,65	215 35 635	
		1,0 m	SK	€ 14,30	€ 17,00	215 35 631	
		0,9 m	SK	€ 13,30	€ 15,85	215 35 630	
H64		2,7 m	SK	€ 37,50	€ 44,65	215 35 645	
		1,0 m	SK	€ 14,30	€ 17,00	215 35 641	
		0,9 m	SK	€ 13,30	€ 15,85	215 35 640	
H65		2,7 m	SK	€ 37,50	€ 44,65	215 35 655	
		1,0 m	SK	€ 14,30	€ 17,00	215 35 651	
		0,9 m	SK	€ 13,30	€ 15,85	215 35 650	
H80		2,7 m	SK	€ 37,50	€ 44,65	215 35 805	
		1,0 m	SK	€ 14,30	€ 17,00	215 35 801	
		0,9 m	SK	€ 13,30	€ 15,85	215 35 800	
H81		2,7 m	SK	€ 37,50	€ 44,65	215 35 835	
		1,0 m	SK	€ 14,30	€ 17,00	215 35 831	
		0,9 m	SK	€ 13,30	€ 15,85	215 35 830	
H95		2,7 m	SK	€ 37,50	€ 44,65	215 35 955	
		1,0 m	SK	€ 14,30	€ 17,00	215 35 951	
		0,9 m	SK	€ 13,30	€ 15,85	215 35 950	
237		F4	5,0 m	V	€ 57,00	€ 67,85	316 37 047
			3,0 m	V	€ 34,20	€ 40,70	316 237 004 8
			2,7 m	V	€ 30,80	€ 36,65	316 37 045
	F4G	3,0 m	V	€ 28,80	€ 34,25	316 37 044	
		1,0 m	V	€ 34,20	€ 40,70	316 237 804 8	
		1,0 m	V	€ 17,00	€ 20,25	316 237 804 1	
	F5	5,0 m	V	€ 64,00	€ 76,15	316 37 057	
		2,7 m	V	€ 34,60	€ 41,15	316 37 055	
		2,5 m	V	€ 32,30	€ 38,45	316 37 054	
	F9	5,0 m	V	€ 57,00	€ 67,85	316 37 097	
		3,0 m	V	€ 34,20	€ 40,70	316 237 009 8	
		2,7 m	V	€ 30,80	€ 36,65	316 37 095	
		2,5 m	V	€ 28,80	€ 34,25	316 37 094	
	F6	5,0 m	V	€ 64,00	€ 76,15	316 37 067	
		3,0 m	V	€ 38,40	€ 45,70	316 237 006 8	
		2,7 m	V	€ 34,60	€ 41,15	316 37 065	
		2,5 m	V	€ 32,30	€ 38,45	316 37 064	
	F2	5,0 m	V	€ 64,00	€ 76,15	316 37 027	
		3,0 m	V	€ 38,40	€ 45,70	316 237 002 8	
		2,7 m	V	€ 34,60	€ 41,15	316 37 025	
		2,5 m	V	€ 32,30	€ 38,45	316 37 024	
	F1G	3,0 m	V	€ 52,50	€ 62,50	316 237 801 8	
		1,0 m	V	€ 18,10	€ 21,55	316 237 801 1	
	F4	5,0 m	SK	€ 61,00	€ 72,60	215 37 047	
		3,0 m	SK	€ 36,60	€ 43,55	215 237 004 8	
		2,7 m	SK	€ 32,90	€ 39,15	215 37 045	
		2,5 m	SK	€ 30,80	€ 36,65	215 37 044	
		1,0 m	SK	€ 12,50	€ 14,90	215 37 041	
	F4G	3,0 m	SK	€ 51,90	€ 61,75	215 237 804 8	
		1,0 m	SK	€ 17,90	€ 21,30	215 237 804 1	
	F5	5,0 m	SK	€ 68,00	€ 80,90	215 37 057	
		2,7 m	SK	€ 36,70	€ 43,65	215 37 055	
		2,5 m	SK	€ 34,30	€ 40,80	215 37 054	
	F9	5,0 m	SK	€ 61,00	€ 72,60	215 37 097	
		3,0 m	SK	€ 36,60	€ 43,55	215 237 009 8	
		2,7 m	SK	€ 32,90	€ 39,15	215 37 095	
		2,5 m	SK	€ 30,80	€ 36,65	215 37 094	
		1,0 m	SK	€ 12,50	€ 14,90	215 37 091	
	F6	5,0 m	SK	€ 68,00	€ 80,90	215 37 067	
		3,0 m	SK	€ 40,80	€ 48,55	215 237 006 8	
		2,7 m	SK	€ 36,70	€ 43,65	215 37 065	
		2,5 m	SK	€ 34,30	€ 40,80	215 37 064	
	F2	5,0 m	SK	€ 68,00	€ 80,90	215 37 027	
		3,0 m	SK	€ 40,80	€ 48,55	215 237 002 8	
		2,7 m	SK	€ 36,70	€ 43,65	215 37 025	
		2,5 m	SK	€ 34,30	€ 40,80	215 37 024	
		1,0 m	SK	€ 13,90	€ 16,55	215 37 021	
	F1G	3,0 m	SK	€ 55,20	€ 65,70	215 237 801 8	
		1,0 m	SK	€ 19,10	€ 22,75	215 237 801 1	
	F16 RAL9005	3,0 m	SK	€ 44,40	€ 52,85	215 237 701 8	
		2,7 m	SK	€ 40,00	€ 47,60	215 237 701 5	
		1,0 m	SK	€ 15,10	€ 17,95	215 237 701 1	
		0,9 m	SK	€ 13,80	€ 16,40	215 237 701 0	
234 SK		F4	5,0 m	SK	€ 83,50	€ 99,35	215 34 047
			3,0 m	SK	€ 50,10	€ 59,60	215 234 004 8
			2,7 m	SK	€ 45,10	€ 53,65	215 34 045
		2,5 m	SK	€ 42,00	€ 50,00	215 34 044	
	F5	5,0 m	SK	€ 90,50	€ 107,70	215 34 057	
		2,7 m	SK	€ 48,90	€ 58,20	215 34 055	
		2,5 m	SK	€ 45,50	€ 54,15	215 34 054	
	F9	5,0 m	SK	€ 83,50	€ 99,35	215 34 097	
		3,0 m	SK	€ 50,10	€ 59,60	215 234 009 8	

Artikel	Farben	Länge	Version	Preis/Stück	unit price	Bestell-Nr.
article	colour	length	version	exkl. MwSt.	inkl. MwSt.	order no.
		2,7 m	SK	€ 45,10	€ 53,65	215 34 095
		2,5 m	SK	€ 42,00	€ 50,00	215 34 094
		5,0 m	SK	€ 90,50	€ 107,70	215 34 067
F6		3,0 m	SK	€ 54,30	€ 64,60	215 234 006 8
		2,7 m	SK	€ 48,90	€ 58,20	215 34 065
		2,5 m	SK	€ 45,50	€ 54,15	215 34 064
F2		5,0 m	SK	€ 90,50	€ 107,70	215 34 027
		3,0 m	SK	€ 54,30	€ 64,60	215 234 002 8
		2,7 m	SK	€ 48,90	€ 58,20	215 34 025
F16 RAL9005		2,5 m	SK	€ 45,50	€ 54,15	215 34 024
		5,0 m	SK	€ 99,00	€ 117,80	215 234 701 7
		3,0 m	SK	€ 59,40	€ 70,70	215 234 701 8
		2,7 m	SK	€ 53,50	€ 63,65	215 234 701 5
		2,5 m	SK	€ 49,80	€ 59,25	215 234 701 4
		1,0 m	SK	€ 20,00	€ 23,80	215 234 701 1
526	F3	5,0 m	V	€ 54,00	€ 64,25	316 26 037
		2,5 m	V	€ 27,30	€ 32,50	316 26 034
		1,0 m	V	€ 11,30	€ 13,45	316 26 031
	F4	5,0 m	V	€ 54,00	€ 64,25	316 26 047
		2,5 m	V	€ 27,30	€ 32,50	316 26 044
		1,0 m	V	€ 11,30	€ 13,45	316 26 041
	F5	5,0 m	V	€ 58,50	€ 69,60	316 26 057
		2,5 m	V	€ 29,50	€ 35,10	316 26 054
		1,0 m	V	€ 12,20	€ 14,50	316 26 051
	F9	5,0 m	V	€ 54,00	€ 64,25	316 26 097
		2,5 m	V	€ 27,30	€ 32,50	316 26 094
		1,0 m	V	€ 11,30	€ 13,45	316 26 091
	F6	5,0 m	V	€ 58,50	€ 69,60	316 26 067
		2,5 m	V	€ 29,50	€ 35,10	316 26 064
		1,0 m	V	€ 12,20	€ 14,50	316 26 061
	F2	5,0 m	V	€ 58,50	€ 69,60	316 26 027
		2,5 m	V	€ 29,50	€ 35,10	316 26 024
		1,0 m	V	€ 12,20	€ 14,50	316 26 021
	F7	5,0 m	V	€ 191,00	€ 227,30	316 26 077
		2,5 m	V	€ 95,50	€ 113,65	316 26 074
		1,0 m	V	€ 38,60	€ 45,95	316 26 071
227	F3	5,0 m	V	€ 64,00	€ 76,15	316 27 037
		2,5 m	V	€ 32,30	€ 38,45	316 27 034
		5,0 m	V	€ 64,00	€ 76,15	316 27 047
	F4	2,5 m	V	€ 32,30	€ 38,45	316 27 044
		5,0 m	V	€ 69,50	€ 82,70	316 27 057
		2,5 m	V	€ 35,00	€ 41,65	316 27 054
	F9	5,0 m	V	€ 64,00	€ 76,15	316 27 097
		2,5 m	V	€ 32,30	€ 38,45	316 27 094
		5,0 m	V	€ 69,50	€ 82,70	316 27 067
	F6	2,5 m	V	€ 35,00	€ 41,65	316 27 064
		5,0 m	V	€ 69,50	€ 82,70	316 27 027
		2,5 m	V	€ 35,00	€ 41,65	316 27 024
226	F3	5,0 m	V	€ 86,00	€ 102,35	316 24 037
		2,5 m	V	€ 43,30	€ 51,55	316 24 034
		5,0 m	V	€ 86,00	€ 102,35	316 24 047
	F4	2,5 m	V	€ 43,30	€ 51,55	316 24 044
		5,0 m	V	€ 94,50	€ 112,45	316 24 057
		2,5 m	V	€ 47,50	€ 56,55	316 24 054
	F9	5,0 m	V	€ 86,00	€ 102,35	316 24 097
		2,5 m	V	€ 43,30	€ 51,55	316 24 094
		5,0 m	V	€ 94,50	€ 112,45	316 24 067
	F6	2,5 m	V	€ 47,50	€ 56,55	316 24 064
		5,0 m	V	€ 94,50	€ 112,45	316 24 027
		2,5 m	V	€ 47,50	€ 56,55	316 24 024
	F7	5,0 m	V	€ 350,50	€ 417,10	316 24 077
		2,5 m	V	€ 175,50	€ 208,85	316 24 074
		225	F3	5,0 m	V	€ 92,00
		3,0 m	V	€ 55,20	€ 65,70	316 25 038
		2,5 m	V	€ 46,30	€ 55,10	316 25 034
		1,0 m	V	€ 18,70	€ 22,25	316 25 031
	F4	5,0 m	V	€ 92,00	€ 109,50	316 25 047
		3,0 m	V	€ 55,20	€ 65,70	316 25 048
		2,5 m	V	€ 46,30	€ 55,10	316 25 044
		1,0 m	V	€ 18,70	€ 22,25	316 25 041
		5,0 m	V	€ 100,00	€ 119,00	316 25 057
		3,0 m	V	€ 66,00	€ 71,40	316 25 058
		2,5 m	V	€ 50,30	€ 59,85	316 25 054
		1,0 m	V	€ 20,70	€ 24,65	316 25 051
		5,0 m	V	€		

Treppenkanten- und Winkelprofile / Stair Nosings and Angle Edges

Artikel article	Farben colour	Länge length	Version version	Preis/Stück unit price		Bestell-Nr. order no.
				exkl. MwSt. incl. VAT	inkl. MwSt. incl. VAT	
228	F7	2,5 m	V	€ 50,30	€ 59,85	316 25 024
		1,0 m	V	€ 20,70	€ 24,65	316 25 021
		5,0 m	V	€ 399,00	€ 474,80	316 25 077
		2,5 m	V	€ 199,80	€ 237,75	316 25 074
		1,0 m	V	€ 80,30	€ 95,55	316 25 071
		5,0 m	V	€ 80,00	€ 95,20	316 28 037
	F3	3,0 m	V	€ 48,00	€ 57,10	316 28 038
		2,5 m	V	€ 40,30	€ 47,95	316 28 034
		1,0 m	V	€ 16,30	€ 19,40	316 28 031
		5,0 m	V	€ 80,00	€ 95,20	316 28 047
		3,0 m	V	€ 48,00	€ 57,10	316 28 048
		2,5 m	V	€ 40,30	€ 47,95	316 28 044
	F4	1,0 m	V	€ 16,30	€ 19,40	316 28 041
		5,0 m	V	€ 90,00	€ 107,10	316 28 057
		3,0 m	V	€ 54,00	€ 64,25	316 28 058
		2,5 m	V	€ 45,30	€ 53,90	316 28 054
		1,0 m	V	€ 18,30	€ 21,80	316 28 051
		5,0 m	V	€ 80,00	€ 95,20	316 28 097
	F5	3,0 m	V	€ 48,00	€ 57,10	316 28 098
		2,5 m	V	€ 40,30	€ 47,95	316 28 094
		1,0 m	V	€ 16,30	€ 19,40	316 28 091
		5,0 m	V	€ 90,00	€ 107,10	316 28 067
		3,0 m	V	€ 54,00	€ 64,25	316 28 068
		2,5 m	V	€ 45,30	€ 53,90	316 28 064
F6	1,0 m	V	€ 18,30	€ 21,80	316 28 061	
	5,0 m	V	€ 90,00	€ 107,10	316 28 027	
	3,0 m	V	€ 54,00	€ 64,25	316 28 028	
	2,5 m	V	€ 45,30	€ 53,90	316 28 024	
	1,0 m	V	€ 18,30	€ 21,80	316 28 021	
	5,0 m	V	€ 96,50	€ 114,85	316 29 037	
229	F3	3,0 m	V	€ 57,90	€ 68,90	316 29 038
		2,5 m	V	€ 48,50	€ 57,70	316 29 034
		1,0 m	V	€ 19,60	€ 23,30	316 29 031
		5,0 m	V	€ 96,50	€ 114,85	316 29 047
		3,0 m	V	€ 57,90	€ 68,90	316 29 048
		2,5 m	V	€ 48,50	€ 57,70	316 29 044
	F4	1,0 m	V	€ 19,60	€ 23,30	316 29 041
		5,0 m	V	€ 108,50	€ 129,10	316 29 057
		3,0 m	V	€ 65,10	€ 77,45	316 29 058
		2,5 m	V	€ 54,50	€ 64,85	316 29 054
		1,0 m	V	€ 22,00	€ 26,20	316 29 051
		5,0 m	V	€ 96,50	€ 114,85	316 29 097
	F5	3,0 m	V	€ 57,90	€ 68,90	316 29 098
		2,5 m	V	€ 48,50	€ 57,70	316 29 094
		1,0 m	V	€ 19,60	€ 23,30	316 29 091
		5,0 m	V	€ 108,50	€ 129,10	316 29 067
		3,0 m	V	€ 65,10	€ 77,45	316 29 068
		2,5 m	V	€ 54,50	€ 64,85	316 29 064
	F9	1,0 m	V	€ 22,00	€ 26,20	316 29 061
		5,0 m	V	€ 108,50	€ 129,10	316 29 027
		3,0 m	V	€ 65,10	€ 77,45	316 29 028
		2,5 m	V	€ 54,50	€ 64,85	316 29 024
		1,0 m	V	€ 22,00	€ 26,20	316 29 021
		5,0 m	V	€ 162,50	€ 193,40	316 30 037
530	F3	2,5 m	V	€ 81,50	€ 97,00	316 30 034
		5,0 m	V	€ 162,50	€ 193,40	316 30 047
		2,5 m	V	€ 81,50	€ 97,00	316 30 044
		1,0 m	V	€ 33,00	€ 39,25	316 30 041
		5,0 m	V	€ 180,50	€ 214,80	316 30 057
		2,5 m	V	€ 90,80	€ 108,05	316 30 054
	F4	5,0 m	V	€ 162,50	€ 193,40	316 30 097
		2,5 m	V	€ 81,50	€ 97,00	316 30 094
		1,0 m	V	€ 33,00	€ 39,25	316 30 091
		5,0 m	V	€ 180,50	€ 214,80	316 30 067
		2,5 m	V	€ 90,80	€ 108,05	316 30 064
		5,0 m	V	€ 180,50	€ 214,80	316 30 027
	F5	2,5 m	V	€ 90,80	€ 108,05	316 30 024
		1,0 m	V	€ 36,70	€ 43,65	316 30 021
		5,0 m	V	€ 70,00	€ 83,30	316 535 004 7
		3,0 m	V	€ 42,00	€ 50,00	316 535 004 8
		2,5 m	V	€ 35,30	€ 42,00	316 535 004 4
		1,0 m	V	€ 14,30	€ 17,00	316 535 004 1
	F9	5,0 m	V	€ 78,00	€ 92,80	316 535 005 7
		3,0 m	V	€ 46,80	€ 55,70	316 535 005 8
		2,5 m	V	€ 39,30	€ 46,75	316 535 005 4
		1,0 m	V	€ 15,80	€ 18,80	316 535 005 1
		5,0 m	V	€ 70,00	€ 83,30	316 535 009 7
		3,0 m	V	€ 42,00	€ 50,00	316 535 009 8
F6	2,5 m	V	€ 35,30	€ 42,00	316 535 009 4	
	1,0 m	V	€ 14,30	€ 17,00	316 535 009 1	
	5,0 m	V	€ 78,00	€ 92,80	316 535 006 7	
	3,0 m	V	€ 46,80	€ 55,70	316 535 006 8	
	2,5 m	V	€ 39,30	€ 46,75	316 535 006 4	
	1,0 m	V	€ 15,80	€ 18,80	316 535 006 1	
F2	5,0 m	V	€ 78,00	€ 92,80	316 535 002 7	
	3,0 m	V	€ 46,80	€ 55,70	316 535 002 8	

Artikel article	Farben colour	Länge length	Version version	Preis/Stück unit price		Bestell-Nr. order no.			
				exkl. MwSt. incl. VAT	inkl. MwSt. incl. VAT				
540	F4	2,5 m	V	€ 39,30	€ 46,75	316 535 002 4			
		1,0 m	V	€ 15,80	€ 18,80	316 535 002 1			
		5,0 m	V	€ 79,00	€ 94,00	316 540 004 7			
		3,0 m	V	€ 47,40	€ 56,40	316 540 004 8			
		2,5 m	V	€ 39,80	€ 47,35	316 540 004 4			
		1,0 m	V	€ 16,00	€ 19,05	316 540 004 1			
	F5	5,0 m	V	€ 87,50	€ 104,15	316 540 005 7			
		3,0 m	V	€ 52,50	€ 62,50	316 540 005 8			
		2,5 m	V	€ 44,00	€ 52,35	316 540 005 4			
		1,0 m	V	€ 17,70	€ 21,05	316 540 005 1			
		5,0 m	V	€ 79,00	€ 94,00	316 540 009 7			
		3,0 m	V	€ 47,40	€ 56,40	316 540 009 8			
	F9	2,5 m	V	€ 39,80	€ 47,35	316 540 009 4			
		1,0 m	V	€ 16,00	€ 19,05	316 540 009 1			
		5,0 m	V	€ 87,50	€ 104,15	316 540 006 7			
		3,0 m	V	€ 52,50	€ 62,50	316 540 006 8			
		2,5 m	V	€ 44,00	€ 52,35	316 540 006 4			
		1,0 m	V	€ 17,70	€ 21,05	316 540 006 1			
	F6	5,0 m	V	€ 87,50	€ 104,15	316 540 002 7			
		3,0 m	V	€ 52,50	€ 62,50	316 540 002 8			
		2,5 m	V	€ 44,00	€ 52,35	316 540 002 4			
		1,0 m	V	€ 17,70	€ 21,05	316 540 002 1			
		Reparaturwinkel / stair levelling angles (verzinktes Eisen/galv. iron)							
		RW 20		1,0 m		€ 6,30	€ 7,50	149 00 011	
RW 38		1,0 m		€ 8,60	€ 10,25	149 00 021			
RW S		1,0 m		€ 8,85	€ 10,55	149 00 031			
Befestigungszubehör / fastening supplies									
für RW 20 und 38 / for RW 20 and 38 - Schraubnägel / screw nails									
				500 St./pcs.	€ 17,60	€ 20,95			
für RW S / for RW S - Senkkopf-Kreuzschlitzschrauben / recessed-head countersunk screws									
				200 St./pcs.	€ 20,10	€ 23,90			
Nylon Euro-Dübel / Nylon Euro dowels									
				200 St./pcs.	€ 5,40	€ 6,45			
238 U	F3	2,7 m	U	€ 19,70	€ 23,45	216 38 035			
		2,7 m	U	€ 19,70	€ 23,45	216 38 045			
	F4	2,7 m	U	€ 21,90	€ 26,05	216 38 055			
		2,7 m	U	€ 19,70	€ 23,45	216 38 095			
	F5	2,7 m	U	€ 21,90	€ 26,05	216 38 065			
		2,7 m	U	€ 24,30	€ 28,90	216 38 025			
	277 U	F3	5,0 m	U	€ 44,00	€ 52,35	211 277 003 7		
			2,5 m	U	€ 22,30	€ 26,55	211 277 003 4		
		F4	5,0 m	U	€ 44,00	€ 52,35	211 277 004 7		
			2,5 m	U	€ 22,30	€ 26,55	211 277 004 4		
F5		5,0 m	U	€ 50,00	€ 59,50	211 277 005 7			
		2,5 m	U	€ 25,30	€ 30,10	211 277 005 4			
F9		5,0 m	U	€ 44,00	€ 52,35	211 277 009 7			
		2,5 m	U	€ 22,30	€ 26,55	211 277 009 4			
F6		5,0 m	U	€ 50,00	€ 59,50	211 277 006 7			
		2,5 m	U	€ 25,30	€ 30,10	211 277 006 4			
F2G	5,0 m	U	€ 54,00	€ 64,25	211 277 002 7				
	2,5 m	U	€ 27,30	€ 32,50	211 277 002 4				
				F16 RAL9005	2,5 m	U	€ 32,00	€ 38,10	211 277 715 4
278 U	F3	5,0 m	U	€ 52,00	€ 61,90	211 278 003 7			
		2,5 m	U	€ 26,30	€ 31,30	211 278 003 4			
	F4	5,0 m	U	€ 52,00	€ 61,90	211 278 004 7			
		2,5 m	U	€ 26,30	€ 31,30	211 278 004 4			
	F5	5,0 m	U	€ 57,00	€ 67,85	211 278 005 7			
		2,5 m	U	€ 28,80	€ 34,25	211 278 005 4			
	F9	5,0 m	U	€ 52,00	€ 61,90	211 278 009 7			
		2,5 m	U	€ 26,30	€ 31,30	211 278 009 4			
	F6	5,0 m	U	€ 57,00	€ 67,85	211 278 006 7			
		2,5 m	U	€ 28,80	€ 34,25	211 278 006 4			
F2G	5,0 m	U	€ 61,50	€ 73,20	211 278 002 7				
	2,5 m	U	€ 31,00	€ 36,90	211 278 002 4				
279 U	F4	3,05 m	U	€ 25,60	€ 30,45	211 278 004 8			
	F2G	3,05 m	U	€ 34,20	€ 40,70	211 278 002 8			
401 U	F4	3,0 m	U	€ 38,40	€ 45,70	273 01 048			
		1,0 m	U	€ 13,40	€ 15,95	273 01 041			
	F5	3,0 m	U	€ 41,40	€ 49,25	273 01 058			
		1,0 m	U	€ 14,40	€ 17,15	273 01 051			
	F9	3,0 m	U	€ 38,40	€ 45,70	273 01 098			
		1,0 m	U	€ 13,40	€ 15,95	273 01 091			
	F6	3,0 m	U	€ 41,40	€ 49,25	273 01 068			
		1,0 m	U	€ 14,40	€ 17,15	273 01 061			
	F2G	3,0 m	U	€ 45,40	€ 54,05	273 01 028			
		1,0 m	U	€ 16,40	€ 19,50	273 01 021			
544 U	F8C	2,5 m	U	€ 192,00	€ 228,50	211 544 401 4			
545 U	F8G	2,5 m	U	€ 693,60	€ 825,40	211 545 401 4			

Artikel	Farben	Länge	Version	Preis/Stück	unit price	Bestell-Nr.
article	colour	length	version	exkl. MwSt. excl. VAT	inkl. MwSt. incl. VAT	order no.

Sicherheits-Treppenkantenprofile Safety Stair Nosings

706 Profil ohne PVC-Einlage profile without PVC insert

F3	5,0 m	A	€ 135,50	€ 161,25	321 06 037
	2,5 m	A	€ 68,00	€ 80,90	321 06 034
F4	5,0 m	A	€ 135,50	€ 161,25	321 06 047
	2,5 m	A	€ 68,00	€ 80,90	321 06 044
F5	5,0 m	A	€ 149,50	€ 177,90	321 06 057
	2,5 m	A	€ 75,00	€ 89,25	321 06 054
F9	5,0 m	A	€ 135,50	€ 161,25	321 06 097
	2,5 m	A	€ 68,00	€ 80,90	321 06 094
F6	5,0 m	A	€ 149,50	€ 177,90	321 06 067
	2,5 m	A	€ 75,00	€ 89,25	321 06 064
F2	5,0 m	A	€ 149,50	€ 177,90	321 06 027
	2,5 m	A	€ 75,00	€ 89,25	321 06 024
F7	5,0 m	A	€ 574,50	€ 683,65	321 06 077
	2,5 m	A	€ 287,50	€ 342,15	321 06 074
F4	5,0 m	C	€ 146,50	€ 174,35	322 06 047
	2,5 m	C	€ 73,50	€ 87,45	322 06 044
F2	5,0 m	C	€ 158,50	€ 188,60	322 06 027
	2,5 m	C	€ 79,50	€ 94,60	322 06 024
F7	5,0 m	C	€ 587,50	€ 699,15	322 06 077
	2,5 m	C	€ 294,00	€ 349,85	322 06 074

708 N Profil ohne PVC-Einlage profile without PVC insert

F3	5,0 m	V	€ 136,50	€ 162,45	32108037-N
	2,5 m	V	€ 68,50	€ 81,50	32108034-N
F4	5,0 m	V	€ 136,50	€ 162,45	32108047-N
	2,5 m	V	€ 68,50	€ 81,50	32108044-N
F5	5,0 m	V	€ 151,00	€ 179,70	32108057-N
	2,5 m	V	€ 75,80	€ 90,20	32108054-N
F9	5,0 m	V	€ 136,50	€ 162,45	32108097-N
	2,5 m	V	€ 68,50	€ 81,50	32108094-N
F6	5,0 m	V	€ 151,00	€ 179,70	32108067-N
	2,5 m	V	€ 75,80	€ 90,20	32108064-N
F2	5,0 m	V	€ 151,00	€ 179,70	32108027-N
	2,5 m	V	€ 75,80	€ 90,20	32108024-N

707 Profil ohne PVC-Einlage profile without PVC insert

F3	5,0 m	A	€ 160,50	€ 191,00	321 07 037
	2,5 m	A	€ 80,50	€ 95,80	321 07 034
F4	5,0 m	A	€ 160,50	€ 191,00	321 07 047
	2,5 m	A	€ 80,50	€ 95,80	321 07 044
F5	5,0 m	A	€ 178,00	€ 211,80	321 07 057
	2,5 m	A	€ 89,30	€ 106,25	321 07 054
F9	5,0 m	A	€ 160,50	€ 191,00	321 07 097
	2,5 m	A	€ 80,50	€ 95,80	321 07 094
F6	5,0 m	A	€ 178,00	€ 211,80	321 07 067
	2,5 m	A	€ 89,30	€ 106,25	321 07 064
F2	5,0 m	A	€ 178,00	€ 211,80	321 07 027
	2,5 m	A	€ 89,30	€ 106,25	321 07 024
F4	5,0 m	C	€ 170,50	€ 202,90	322 07 047
	2,5 m	C	€ 85,50	€ 101,75	322 07 044
F2	5,0 m	C	€ 187,00	€ 222,55	322 07 027
	2,5 m	C	€ 93,80	€ 111,60	322 07 024

700 Profil ohne PVC-Einlage profile without PVC insert

F4	5,0 m	V	€ 121,00	€ 144,00	321 700 004 7
	2,5 m	V	€ 60,80	€ 72,35	321 700 004 4
F2	5,0 m	V	€ 132,50	€ 157,70	321 700 002 7
	2,5 m	V	€ 66,50	€ 79,15	321 700 002 4

701 Profil ohne PVC-Einlage profile without PVC insert

F3	5,0 m	V	€ 79,00	€ 94,00	323 01 037
	2,5 m	V	€ 39,80	€ 47,35	323 01 034
F4	5,0 m	V	€ 79,00	€ 94,00	323 01 047
	2,5 m	V	€ 39,80	€ 47,35	323 01 044
F5	5,0 m	V	€ 84,50	€ 100,55	323 01 057
	2,5 m	V	€ 42,50	€ 50,60	323 01 054
F9	5,0 m	V	€ 79,00	€ 94,00	323 01 097
	2,5 m	V	€ 39,80	€ 47,35	323 01 094
F6	5,0 m	V	€ 84,50	€ 100,55	323 01 067
	2,5 m	V	€ 42,50	€ 50,60	323 01 064
F2	5,0 m	V	€ 84,50	€ 100,55	323 01 027
	2,5 m	V	€ 42,50	€ 50,60	323 01 024

Artikel	Farben	Länge	Version	Preis/Stück	unit price	Bestell-Nr.
article	colour	length	version	exkl. MwSt. excl. VAT	inkl. MwSt. incl. VAT	order no.

702 Profil ohne PVC-Einlage profile without PVC insert

F3	5,0 m	V	€ 93,00	€ 110,65	323 02 037
	2,5 m	V	€ 46,80	€ 55,70	323 02 034
F4	5,0 m	V	€ 93,00	€ 110,65	323 02 047
	2,5 m	V	€ 46,80	€ 55,70	323 02 044
F5	5,0 m	V	€ 97,00	€ 115,45	323 02 057
	2,5 m	V	€ 48,80	€ 58,05	323 02 054
F9	5,0 m	V	€ 93,00	€ 110,65	323 02 097
	2,5 m	V	€ 46,80	€ 55,70	323 02 094
F6	5,0 m	V	€ 97,00	€ 115,45	323 02 067
	2,5 m	V	€ 48,80	€ 58,05	323 02 064
F2	5,0 m	V	€ 97,00	€ 115,45	323 02 027
	2,5 m	V	€ 48,80	€ 58,05	323 02 024

705 Profil ohne PVC-Einlage profile without PVC insert

F3	5,0 m	V	€ 109,50	€ 130,30	323 05 037
	2,5 m	V	€ 55,00	€ 65,45	323 05 034
F4	5,0 m	V	€ 109,50	€ 130,30	323 05 047
	2,5 m	V	€ 55,00	€ 65,45	323 05 044
F5	5,0 m	V	€ 118,50	€ 141,00	323 05 057
	2,5 m	V	€ 59,50	€ 70,80	323 05 054
F9	5,0 m	V	€ 109,50	€ 130,30	323 05 097
	2,5 m	V	€ 55,00	€ 65,45	323 05 094
F6	5,0 m	V	€ 118,50	€ 141,00	323 05 067
	2,5 m	V	€ 59,50	€ 70,80	323 05 064
F2	5,0 m	V	€ 118,50	€ 141,00	323 05 027
	2,5 m	V	€ 59,50	€ 70,80	323 05 024

709 Profil ohne PVC-Einlage profile without PVC insert

F4	5,0 m	V	€ 111,00	€ 132,10	323 709 004 7
	2,5 m	V	€ 55,80	€ 66,40	323 709 004 4
F5	5,0 m	V	€ 122,50	€ 145,80	323 709 005 7
	2,5 m	V	€ 61,50	€ 73,20	323 709 005 4
F9	5,0 m	V	€ 111,00	€ 132,10	323 709 009 7
	2,5 m	V	€ 55,80	€ 66,40	323 709 009 4
F6	5,0 m	V	€ 122,50	€ 145,80	323 709 006 7
	2,5 m	V	€ 61,50	€ 73,20	323 709 006 4
F2	5,0 m	V	€ 122,50	€ 145,80	323 709 002 7
	2,5 m	V	€ 61,50	€ 73,20	323 709 002 4

703 Profil ohne PVC-Einlage profile without PVC insert

F4	5,0 m	V	€ 101,00	€ 120,20	323 03 047
	2,5 m	V	€ 50,80	€ 60,45	323 03 044
F5	5,0 m	V	€ 106,50	€ 126,75	323 03 057
	2,5 m	V	€ 53,50	€ 63,65	323 03 054
F9	5,0 m	V	€ 101,00	€ 120,20	323 03 097
	2,5 m	V	€ 50,80	€ 60,45	323 03 094
F6	5,0 m	V	€ 106,50	€ 126,75	323 03 067
	2,5 m	V	€ 53,50	€ 63,65	323 03 064
F2	5,0 m	V	€ 106,50	€ 126,75	323 03 027
	2,5 m	V	€ 53,50	€ 63,65	323 03 024

704 Profil ohne PVC-Einlage profile without PVC insert

F4	5,0 m	V	€ 123,50	€ 146,95	323 04 047
	2,5 m	V	€ 62,00	€ 73,80	323 04 044
F5	5,0 m	V	€ 136,50	€ 162,45	323 04 057
	2,5 m	V	€ 68,50	€ 81,50	323 04 054
F9	5,0 m	V	€ 123,50	€ 146,95	323 04 097
	2,5 m	V	€ 62,00	€ 73,80	323 04 094
F6	5,0 m	V	€ 136,50	€ 162,45	323 04 067
	2,5 m	V	€ 68,50	€ 81,50	323 04 064
F2	5,0 m	V	€ 136,50	€ 162,45	323 04 027
	2,5 m	V	€ 68,50	€ 81,50	323 04 024

Reno-TK Treppenkantenprofile Reno-TK Stair Nosings

711 Profil ohne Gleitschutzeinlage – 13 mm profile without anti slip insert – 13 mm

F3	5,0 m	V	€ 72,50	€ 86,30	323 11 037
	2,5 m	V	€ 36,50	€ 43,45	323 11 034
	1,0 m	V	€ 14,90	€ 17,75	323 11 031
F4	5,0 m	V	€ 72,50	€ 86,30	323 11 047
	2,5 m	V	€ 36,50	€ 43,45	323 11 044
	1,0 m	V	€ 14,90	€ 17,75	323 11 041
F5	5,0 m	V	€ 80,50	€ 95,80	323 11 057

Artikel	Farben	Länge	Version	Preis/Stück	unit price	Bestell-Nr.
article	colour	length	version	exkl. MwSt.	inkl. MwSt.	order no.
F9		2,5 m	V	€ 40,50	€ 48,20	323 11 054
		1,0 m	V	€ 16,40	€ 19,50	323 11 051
		5,0 m	V	€ 72,50	€ 86,30	323 11 097
F6		2,5 m	V	€ 36,50	€ 43,45	323 11 094
		1,0 m	V	€ 14,90	€ 17,75	323 11 091
		5,0 m	V	€ 80,50	€ 95,80	323 11 067
F2		2,5 m	V	€ 40,50	€ 48,20	323 11 064
		1,0 m	V	€ 16,40	€ 19,50	323 11 061
		5,0 m	V	€ 80,50	€ 95,80	323 11 027
F7		2,5 m	V	€ 40,50	€ 48,20	323 11 024
		1,0 m	V	€ 16,40	€ 19,50	323 11 021
		5,0 m	V	€ 243,50	€ 289,75	323 11 077
		2,5 m	V	€ 121,80	€ 144,95	323 11 074

PVC-Einlagen / PVC inserts

2504	F100	25,0 m		€ 107,50	€ 127,95	125 04 908
	F130	25,0 m		€ 107,50	€ 127,95	125 04 918
	F140	25,0 m		€ 107,50	€ 127,95	125 04 938
	F142	25,0 m		€ 107,50	€ 127,95	125 04 948
	F143	25,0 m		€ 107,50	€ 127,95	125 04 958
	F149	25,0 m		€ 107,50	€ 127,95	125 04 968
	F169	25,0 m		€ 107,50	€ 127,95	125 04 978
	F189	25,0 m		€ 107,50	€ 127,95	125 04 998
	F190	25,0 m		€ 107,50	€ 127,95	125 04 898
	F200	25,0 m		€ 797,50	€ 949,05	125 04 808
2505	F100	25,0 m		€ 107,50	€ 127,95	125 05 908
	F130	25,0 m		€ 107,50	€ 127,95	125 05 918
	F140	25,0 m		€ 107,50	€ 127,95	125 05 938
	F142	25,0 m		€ 107,50	€ 127,95	125 05 948
	F143	25,0 m		€ 107,50	€ 127,95	125 05 958
	F149	25,0 m		€ 107,50	€ 127,95	125 05 968
	F169	25,0 m		€ 107,50	€ 127,95	125 05 978
	F189	25,0 m		€ 107,50	€ 127,95	125 05 998
	F190	25,0 m		€ 107,50	€ 127,95	125 05 898
	F200	25,0 m		€ 440,00	€ 523,60	125 05 808

Gleitschutzeinlage – 13 mm, einzeln
anti slip insert – 13 mm, individual

2510/13	GE1	25,0 m	SK	€ 40,00	€ 47,60	114 13 018
	GE3	25,0 m	SK	€ 40,00	€ 47,60	114 13 038
	GE5	25,0 m	SK	€ 40,00	€ 47,60	114 13 058
2511/13	GM7	25,0 m	SK	€ 77,50	€ 92,25	114 43 018
	GM8	25,0 m	SK	€ 77,50	€ 92,25	114 43 078
	GM9	25,0 m	SK	€ 77,50	€ 92,25	114 43 068
2512/13	GS1	25,0 m	SK	€ 77,50	€ 92,25	125 13 018
	GS2	25,0 m	SK	€ 77,50	€ 92,25	125 13 028
	GS3	25,0 m	SK	€ 77,50	€ 92,25	125 13 038
	GS4	25,0 m	SK	€ 77,50	€ 92,25	125 13 048
	GS5	25,0 m	SK	€ 77,50	€ 92,25	125 13 058
	GS6	25,0 m	SK	€ 77,50	€ 92,25	125 13 068

Gleitschutzeinlage, einzeln
anti slip insert, individual

2510/19	GM7	25,0 m	SK	€ 112,50	€ 133,90	114 63 018
2510/23	GE1	25,0 m	SK	€ 72,50	€ 86,30	114 23 018
	GE3	25,0 m	SK	€ 72,50	€ 86,30	114 23 038
	GE5	25,0 m	SK	€ 72,50	€ 86,30	114 23 058
2511/23	GM7	25,0 m	SK	€ 112,50	€ 133,90	114 53 018
	GM8	25,0 m	SK	€ 112,50	€ 133,90	114 53 078
	GM9	25,0 m	SK	€ 112,50	€ 133,90	114 53 068
	GM10	25,0 m	SK	€ 112,50	€ 133,90	114 53 088
2512/23	GS1	25,0 m	SK	€ 112,50	€ 133,90	125 23 018
	GS2	25,0 m	SK	€ 112,50	€ 133,90	125 23 028
	GS3	25,0 m	SK	€ 112,50	€ 133,90	125 23 038
	GS4	25,0 m	SK	€ 112,50	€ 133,90	125 23 048
	GS5	25,0 m	SK	€ 112,50	€ 133,90	125 23 058
	GS6	25,0 m	SK	€ 112,50	€ 133,90	125 23 068
2511/30	GM7	25,0 m	SK	€ 112,50	€ 133,90	114 73 018
	GM10	25,0 m	SK	€ 112,50	€ 133,90	114 73 088

712 Profil ohne Gleitschutzeinlage – 23 mm
profile without anti slip insert – 23 mm

F3		5,0 m	V	€ 110,50	€ 131,50	323 12 037
		2,5 m	V	€ 55,50	€ 66,05	323 12 034
F4		5,0 m	V	€ 110,50	€ 131,50	323 12 047
		2,5 m	V	€ 55,50	€ 66,05	323 12 044
F5		5,0 m	V	€ 115,00	€ 136,85	323 12 057
		2,5 m	V	€ 57,80	€ 68,80	323 12 054
F9		5,0 m	V	€ 110,50	€ 131,50	323 12 097
		2,5 m	V	€ 55,50	€ 66,05	323 12 094

Artikel	Farben	Länge	Version	Preis/Stück	unit price	Bestell-Nr.
article	colour	length	version	exkl. MwSt.	inkl. MwSt.	order no.
F6		5,0 m	V	€ 115,00	€ 136,85	323 12 067
		2,5 m	V	€ 57,80	€ 68,80	323 12 064
F2		5,0 m	V	€ 115,00	€ 136,85	323 12 027
		2,5 m	V	€ 57,80	€ 68,80	323 12 024
F7		5,0 m	V	€ 439,50	€ 523,00	323 12 077
		2,5 m	V	€ 220,00	€ 261,80	323 12 074
715	Profil ohne Gleitschutzeinlage – 19 mm profile without anti slip insert – 19 mm					
F4		3,0 m	V	€ 96,60	€ 114,95	323 715 004 8
		3,0 m	V	€ 100,80	€ 119,95	323 715 002 8
713	Profil ohne Gleitschutzeinlage – 23+30 mm profile without anti slip insert – 23+30 mm					
F4		3,0 m	V	€ 66,60	€ 79,25	323 713 004 8
		3,0 m	V	€ 69,60	€ 82,80	323 713 002 8

Treppenkantenprofile
Stair Nosings

809	F3	5,0 m	V	€ 54,00	€ 64,25	317 09 037
		2,5 m	V	€ 27,30	€ 32,50	317 09 034
		1,0 m	V	€ 11,30	€ 13,45	317 09 031
F4		5,0 m	V	€ 54,00	€ 64,25	317 09 047
		2,5 m	V	€ 27,30	€ 32,50	317 09 044
		1,0 m	V	€ 11,30	€ 13,45	317 09 041
F5		5,0 m	V	€ 58,50	€ 69,60	317 09 057
		2,5 m	V	€ 29,50	€ 35,10	317 09 054
		1,0 m	V	€ 12,20	€ 14,50	317 09 051
F9		5,0 m	V	€ 54,00	€ 64,25	317 09 097
		2,5 m	V	€ 27,30	€ 32,50	317 09 094
		1,0 m	V	€ 11,30	€ 13,45	317 09 091
F6		5,0 m	V	€ 58,50	€ 69,60	317 09 067
		2,5 m	V	€ 29,50	€ 35,10	317 09 064
		1,0 m	V	€ 12,20	€ 14,50	317 09 061
F2		5,0 m	V	€ 58,50	€ 69,60	317 09 027
		2,5 m	V	€ 29,50	€ 35,10	317 09 024
		1,0 m	V	€ 12,20	€ 14,50	317 09 021
807	F3	5,0 m	V	€ 57,50	€ 68,45	317 07 037
		2,5 m	V	€ 29,00	€ 34,50	317 07 034
		1,0 m	V	€ 11,90	€ 14,15	317 07 031
F4		5,0 m	V	€ 57,50	€ 68,45	317 07 047
		2,5 m	V	€ 29,00	€ 34,50	317 07 044
		1,0 m	V	€ 11,90	€ 14,15	317 07 041
F5		5,0 m	V	€ 64,50	€ 76,75	317 07 057
		2,5 m	V	€ 32,50	€ 38,70	317 07 054
		1,0 m	V	€ 13,30	€ 15,85	317 07 051
F9		5,0 m	V	€ 57,50	€ 68,45	317 07 097
		2,5 m	V	€ 29,00	€ 34,50	317 07 094
		1,0 m	V	€ 11,90	€ 14,15	317 07 091
F6		5,0 m	V	€ 64,50	€ 76,75	317 07 067
		2,5 m	V	€ 32,50	€ 38,70	317 07 064
		1,0 m	V	€ 13,30	€ 15,85	317 07 061
F2		5,0 m	V	€ 64,50	€ 76,75	317 07 027
		2,5 m	V	€ 32,50	€ 38,70	317 07 024
		1,0 m	V	€ 13,30	€ 15,85	317 07 021
808	F3	5,0 m	V	€ 59,50	€ 70,80	317 08 037
		2,5 m	V	€ 30,00	€ 35,70	317 08 034
		1,0 m	V	€ 12,70	€ 15,10	317 08 031
F4		5,0 m	V	€ 59,50	€ 70,80	317 08 047
		2,5 m	V	€ 30,00	€ 35,70	317 08 044
		1,0 m	V	€ 12,70	€ 15,10	317 08 041
F5		5,0 m	V	€ 66,50	€ 79,15	317 08 057
		2,5 m	V	€ 33,50	€ 39,85	317 08 054
		1,0 m	V	€ 13,80	€ 16,40	317 08 051
F9		5,0 m	V	€ 59,50	€ 70,80	317 08 097
		2,5 m	V	€ 30,00	€ 35,70	317 08 094
		1,0 m	V	€ 12,70	€ 15,10	317 08 091
F6		5,0 m	V	€ 66,50	€ 79,15	317 08 067
		2,5 m	V	€ 33,50	€ 39,85	317 08 064
		1,0 m	V	€ 13,80	€ 16,40	317 08 061
F2		5,0 m	V	€ 66,50	€ 79,15	317 08 027
		2,5 m	V	€ 33,50	€ 39,85	317 08 024
		1,0 m	V	€ 13,80	€ 16,40	317 08 021
810	F3	5,0 m	V	€ 60,50	€ 72,00	317 24 037
		2,5 m	V	€ 30,50	€ 36,30	317 24 034
		1,0 m	V	€ 12,60	€ 15,00	317 24 031
F4		5,0 m	V	€ 60,50	€ 72,00	317 24 047
		2,5 m	V	€ 30,50	€ 36,30	317 24 044
		1,0 m	V	€ 12,60	€ 15,00	317 24 041
F5		5,0 m	V	€ 66,50	€ 79,15	317 24 057
		2,5 m	V	€ 33,50	€ 39,85	317 24 054
		1,0 m	V	€ 13,60	€ 16,20	317 24 051

Treppenkanten- und Winkelprofile / Stair Nosings and Angle Edges

Artikel	Farben	Länge	Version	Preis/Stück	unit price	Bestell-Nr.
article	colour	length	version	exkl. MwSt.	inkl. MwSt.	order no.
F9		5,0 m	V	€ 60,50	€ 72,00	317 24 097
		2,5 m	V	€ 30,50	€ 36,30	317 24 094
		1,0 m	V	€ 12,60	€ 15,00	317 24 091
F6		5,0 m	V	€ 66,50	€ 79,15	317 24 067
		2,5 m	V	€ 33,50	€ 39,85	317 24 064
		1,0 m	V	€ 13,60	€ 16,20	317 24 061
F2		5,0 m	V	€ 66,50	€ 79,15	317 24 027
		2,5 m	V	€ 33,50	€ 39,85	317 24 024
		1,0 m	V	€ 13,60	€ 16,20	317 24 021
811	F3	5,0 m	V	€ 66,50	€ 79,15	317 21 037
		2,5 m	V	€ 33,50	€ 39,85	317 21 034
		1,0 m	V	€ 13,60	€ 16,20	317 21 031
F4		5,0 m	V	€ 66,50	€ 79,15	317 21 047
		2,5 m	V	€ 33,50	€ 39,85	317 21 044
		1,0 m	V	€ 13,60	€ 16,20	317 21 041
F5		5,0 m	V	€ 72,00	€ 85,70	317 21 057
		2,5 m	V	€ 36,30	€ 43,20	317 21 054
		1,0 m	V	€ 14,70	€ 17,50	317 21 051
F9		5,0 m	V	€ 66,50	€ 79,15	317 21 097
		2,5 m	V	€ 33,50	€ 39,85	317 21 094
		1,0 m	V	€ 13,60	€ 16,20	317 21 091
F6		5,0 m	V	€ 72,00	€ 85,70	317 21 067
		2,5 m	V	€ 36,30	€ 43,20	317 21 064
		1,0 m	V	€ 14,70	€ 17,50	317 21 061
F2		5,0 m	V	€ 72,00	€ 85,70	317 21 027
		2,5 m	V	€ 36,30	€ 43,20	317 21 024
		1,0 m	V	€ 14,70	€ 17,50	317 21 021
812	F4	5,0 m	V	€ 71,50	€ 85,10	317 22 047
		2,5 m	V	€ 36,00	€ 42,85	317 22 044
		1,0 m	V	€ 14,60	€ 17,35	317 22 041
F6		5,0 m	V	€ 76,50	€ 91,05	317 22 067
		2,5 m	V	€ 38,50	€ 45,80	317 22 064
		1,0 m	V	€ 15,60	€ 18,55	317 22 061
F2		5,0 m	V	€ 76,50	€ 91,05	317 22 027
		2,5 m	V	€ 38,50	€ 45,80	317 22 024
		1,0 m	V	€ 15,60	€ 18,55	317 22 021
813	F4	5,0 m	V	€ 73,50	€ 87,45	317 23 047
		2,5 m	V	€ 37,00	€ 44,05	317 23 044
		1,0 m	V	€ 15,10	€ 17,95	317 23 041
F6		5,0 m	V	€ 80,50	€ 95,80	317 23 067
		2,5 m	V	€ 40,50	€ 48,20	317 23 064
		1,0 m	V	€ 16,40	€ 19,50	317 23 061
F2		5,0 m	V	€ 80,50	€ 95,80	317 23 027
		2,5 m	V	€ 40,50	€ 48,20	317 23 024
		1,0 m	V	€ 16,40	€ 19,50	317 23 021
826	F3	5,0 m	V	€ 75,50	€ 89,85	326 826 003 7
		2,5 m	V	€ 38,00	€ 45,20	326 826 003 4
		1,0 m	V	€ 15,50	€ 18,35	326 826 003 1
F4		5,0 m	V	€ 75,50	€ 89,85	326 826 004 7
		2,5 m	V	€ 38,00	€ 45,20	326 826 004 4
		1,0 m	V	€ 15,50	€ 18,35	326 826 004 1
F5		5,0 m	V	€ 87,50	€ 104,15	326 826 005 7
		2,5 m	V	€ 44,00	€ 52,35	326 826 005 4
		1,0 m	V	€ 16,40	€ 19,50	326 826 005 1
F9		5,0 m	V	€ 75,50	€ 89,85	326 826 009 7
		2,5 m	V	€ 38,00	€ 45,20	326 826 009 4
		1,0 m	V	€ 15,50	€ 18,35	326 826 009 1
F6		5,0 m	V	€ 87,50	€ 104,15	326 826 006 7
		2,5 m	V	€ 44,00	€ 52,35	326 826 006 4
		1,0 m	V	€ 16,40	€ 19,50	326 826 006 1
F2		5,0 m	V	€ 87,50	€ 104,15	326 826 002 7
		2,5 m	V	€ 44,00	€ 52,35	326 826 002 4
		1,0 m	V	€ 16,40	€ 19,50	326 826 002 1
828	F3	5,0 m	V	€ 80,00	€ 95,20	326 828 003 7
		2,5 m	V	€ 40,30	€ 47,95	326 828 003 4
		1,0 m	V	€ 16,30	€ 19,15	326 828 003 1
F4		5,0 m	V	€ 80,00	€ 95,20	326 828 004 7
		2,5 m	V	€ 40,30	€ 47,95	326 828 004 4
		1,0 m	V	€ 16,30	€ 19,15	326 828 004 1
F5		5,0 m	V	€ 91,00	€ 108,30	326 828 005 7
		2,5 m	V	€ 45,80	€ 54,50	326 828 005 4
		1,0 m	V	€ 17,30	€ 20,15	326 828 005 1
F9		5,0 m	V	€ 80,00	€ 95,20	326 828 009 7
		2,5 m	V	€ 40,30	€ 47,95	326 828 009 4
		1,0 m	V	€ 16,30	€ 19,15	326 828 009 1
F6		5,0 m	V	€ 91,00	€ 108,30	326 828 006 7
		2,5 m	V	€ 45,80	€ 54,50	326 828 006 4
		1,0 m	V	€ 17,30	€ 20,15	326 828 006 1
F2		5,0 m	V	€ 91,00	€ 108,30	326 828 002 7
		2,5 m	V	€ 45,80	€ 54,50	326 828 002 4
		1,0 m	V	€ 17,30	€ 20,15	326 828 002 1
830	F3	5,0 m	V	€ 81,00	€ 96,40	326 830 003 7
		2,5 m	V	€ 40,80	€ 48,55	326 830 003 4
		1,0 m	V	€ 16,50	€ 19,35	326 830 003 1
F4		5,0 m	V	€ 81,00	€ 96,40	326 830 004 7
		2,5 m	V	€ 40,80	€ 48,55	326 830 004 4
		1,0 m	V	€ 16,50	€ 19,35	326 830 004 1
F5		5,0 m	V	€ 92,00	€ 109,50	326 830 005 7
		2,5 m	V	€ 46,30	€ 55,10	326 830 005 4
		1,0 m	V	€ 17,00	€ 20,10	326 830 005 1
F9		5,0 m	V	€ 81,00	€ 96,40	326 830 009 7
		2,5 m	V	€ 40,80	€ 48,55	326 830 009 4
		1,0 m	V	€ 16,50	€ 19,35	326 830 009 1
F6		5,0 m	V	€ 92,00	€ 109,50	326 830 006 7
		2,5 m	V	€ 46,30	€ 55,10	326 830 006 4
		1,0 m	V	€ 17,00	€ 20,10	326 830 006 1
F2		5,0 m	V	€ 92,00	€ 109,50	326 830 002 7
		2,5 m	V	€ 46,30	€ 55,10	326 830 002 4
		1,0 m	V	€ 17,00	€ 20,10	326 830 002 1
209	F3	3,0 m	V	€ 57,30	€ 68,20	326 09 038
		2,7 m	V	€ 51,60	€ 61,40	326 09 035
		1,0 m	V	€ 19,40	€ 23,10	326 09 031
F4		3,0 m	V	€ 57,30	€ 68,20	326 09 048

Artikel	Farben	Länge	Version	Preis/Stück	unit price	Bestell-Nr.
article	colour	length	version	exkl. MwSt.	inkl. MwSt.	order no.
		2,7 m	V	€ 51,60	€ 61,40	326 09 045
		1,0 m	V	€ 19,40	€ 23,10	326 09 041
		3,0 m	V	€ 63,60	€ 75,70	326 09 058
F5		2,7 m	V	€ 57,20	€ 68,05	326 09 055
		1,0 m	V	€ 21,50	€ 25,60	326 09 051
		3,0 m	V	€ 57,30	€ 68,20	326 09 098
F9		2,7 m	V	€ 51,60	€ 61,40	326 09 095
		1,0 m	V	€ 19,40	€ 23,10	326 09 091
		3,0 m	V	€ 63,60	€ 75,70	326 09 068
F6		2,7 m	V	€ 57,20	€ 68,05	326 09 065
		1,0 m	V	€ 21,50	€ 25,60	326 09 061
		3,0 m	V	€ 63,60	€ 75,70	326 09 028
F2		2,7 m	V	€ 57,20	€ 68,05	326 09 025
		1,0 m	V	€ 21,50	€ 25,60	326 09 021
		3,0 m	V	€ 63,60	€ 75,70	326 08 048
208	F4	3,0 m	V	€ 59,10	€ 70,35	326 08 048
		1,0 m	V	€ 20,10	€ 23,90	326 08 041
		3,0 m	V	€ 66,00	€ 78,55	326 08 068
F6		1,0 m	V	€ 22,30	€ 26,55	326 08 061
		3,0 m	V	€ 66,00	€ 78,55	326 08 028
		1,0 m	V	€ 22,30	€ 26,55	326 08 021
207	F4	3,0 m	V	€ 62,40	€ 74,25	326 07 048
		1,0 m	V	€ 21,20	€ 25,25	326 07 041
		3,0 m	V	€ 68,40	€ 81,40	326 07 068
F6		1,0 m	V	€ 23,10	€ 27,50	326 07 061
		3,0 m	V	€ 68,40	€ 81,40	326 07 028
		1,0 m	V	€ 23,10	€ 27,50	326 07 021
206	F3	3,0 m	V	€ 64,20	€ 76,40	326 06 038
		1,0 m	V	€ 21,90	€ 26,05	326 06 031
		3,0 m	V	€ 64,20	€ 76,40	326 06 048
F4		1,0 m	V	€ 21,90	€ 26,05	326 06 041
		3,0 m	V	€ 70,50	€ 83,90	326 06 058
		1,0 m	V	€ 23,80	€ 28,30	326 06 051
F9		3,0 m	V	€ 64,20	€ 76,40	326 06 098
		1,0 m	V	€ 21,90	€ 26,05	326 06 091
		3,0 m	V	€ 70,50	€ 83,90	326 06 068
F6		1,0 m	V	€ 23,80	€ 28,30	326 06 061
		3,0 m	V	€ 70,50	€ 83,90	326 06 028
		1,0 m	V	€ 23,80	€ 28,30	326 06 021
832	F3	5,0 m	V	€ 99,50	€ 118,40	323 832 003 7
		2,5 m	V	€ 50,00	€ 59,50	323 832 003 4
		1,0 m	V	€ 18,50	€ 22,10	323 832 003 1
F4		5,0 m	V	€ 99,50	€ 118,40	323 832 004 7
		2,5 m	V	€ 50,00	€ 59,50	323 832 004 4
		1,0 m	V	€ 18,50	€ 22,10	323 832 004 1
F5		5,0 m	V	€ 113,00	€ 134,45	323 832 005 7
		2,5 m	V	€ 56,80	€ 67,60	323 832 005 4
		1,0 m	V	€ 20,50	€ 24,60	323 832 005 1
F9		5,0 m	V	€ 99,50	€ 118,40	323 832 009 7
		2,5 m	V	€ 50,00	€ 59,50	323 832 009 4
		1,0 m	V	€ 18,50	€ 22,10	323 832 009 1
F6		5,0 m	V	€ 113,00	€ 134,45	323 832 006 7
		2,5 m	V	€ 56,80	€ 67,60	323 832 006 4
		1,0 m	V	€ 20,50	€ 24,60	323 832 006 1
F2		5,0 m	V	€ 113,00	€ 134,45	323 832 002 7
		2,5 m	V	€ 56,80	€ 67,60	323 832 002 4
		1,0 m	V	€ 20,50	€ 24,60	323 832 002 1
835	F3	5,0 m	V	€ 105,50	€ 125,55	323 835 003 7
		2,5 m	V	€ 53,00	€ 63,05	323 835 003 4
		1,0 m	V	€ 19,50	€ 23,40	323 835 003 1
F4		5,0 m	V	€ 105,50		

Treppenkanten- und Winkelprofile / Stair Nosings and Angle Edges

Artikel	Farben	Länge	Version	Preis/Stück	unit price	Bestell-Nr.
article	colour	length	version	exkl. MwSt.	inkl. MwSt.	order no.
F5		5,0 m	V	€ 73,00	€ 86,85	323 55 057
		2,5 m	V	€ 36,80	€ 43,80	323 55 054
F9		5,0 m	V	€ 67,50	€ 80,35	323 55 097
		2,5 m	V	€ 34,00	€ 40,45	323 55 094
F6		5,0 m	V	€ 73,00	€ 86,85	323 55 067
		2,5 m	V	€ 36,80	€ 43,80	323 55 064
F2		5,0 m	V	€ 73,00	€ 86,85	323 55 027
		2,5 m	V	€ 36,80	€ 43,80	323 55 024
F7		5,0 m	V	€ 261,00	€ 310,60	323 55 077
		2,5 m	V	€ 130,80	€ 155,65	323 55 074
850		5,0 m	V	€ 72,50	€ 86,30	323 50 037
		2,5 m	V	€ 36,50	€ 43,45	323 50 034
F4		5,0 m	V	€ 72,50	€ 86,30	323 50 047
		2,5 m	V	€ 36,50	€ 43,45	323 50 044
F5		5,0 m	V	€ 79,50	€ 94,60	323 50 057
		2,5 m	V	€ 40,00	€ 47,60	323 50 054
F9		5,0 m	V	€ 72,50	€ 86,30	323 50 097
		2,5 m	V	€ 36,50	€ 43,45	323 50 094
F6		5,0 m	V	€ 79,50	€ 94,60	323 50 067
		2,5 m	V	€ 40,00	€ 47,60	323 50 064
F2		5,0 m	V	€ 79,50	€ 94,60	323 50 027
		2,5 m	V	€ 40,00	€ 47,60	323 50 024
F7		5,0 m	V	€ 293,50	€ 349,25	323 50 077
		2,5 m	V	€ 147,00	€ 174,95	323 50 074
852		5,0 m	V	€ 97,50	€ 116,05	323 52 037
		2,5 m	V	€ 49,00	€ 58,30	323 52 034
F4		5,0 m	V	€ 97,50	€ 116,05	323 52 047
		2,5 m	V	€ 49,00	€ 58,30	323 52 044
F5		5,0 m	V	€ 103,00	€ 122,55	323 52 057
		2,5 m	V	€ 51,80	€ 61,65	323 52 054
F9		5,0 m	V	€ 97,50	€ 116,05	323 52 097
		2,5 m	V	€ 49,00	€ 58,30	323 52 094
F6		5,0 m	V	€ 103,00	€ 122,55	323 52 067
		2,5 m	V	€ 51,80	€ 61,65	323 52 064
F2		5,0 m	V	€ 103,00	€ 122,55	323 52 027
		2,5 m	V	€ 51,80	€ 61,65	323 52 024
857		5,0 m	V	€ 83,50	€ 99,35	323 57 037
		2,5 m	V	€ 42,00	€ 50,00	323 57 034
F4		5,0 m	V	€ 83,50	€ 99,35	323 57 047
		2,5 m	V	€ 42,00	€ 50,00	323 57 044
F5		5,0 m	V	€ 93,50	€ 111,25	323 57 057
		2,5 m	V	€ 47,00	€ 55,95	323 57 054
F9		5,0 m	V	€ 83,50	€ 99,35	323 57 097
		2,5 m	V	€ 42,00	€ 50,00	323 57 094
F6		5,0 m	V	€ 93,50	€ 111,25	323 57 067
		2,5 m	V	€ 47,00	€ 55,95	323 57 064
F2		5,0 m	V	€ 93,50	€ 111,25	323 57 027
		2,5 m	V	€ 47,00	€ 55,95	323 57 024

Treppenkantenprofile für LVT-, CV- oder PVC-Böden Stair Nosings for LVT-, CV- or PVC-flooring

845	F4	3,0 m	V	€ 59,70	€ 71,05	323 845 004 8
				€ 63,90	€ 76,05	323 845 002 8
F16 RAL9005	3,0 m	V	€ 71,40	€ 84,95	323 845 701 8	
			€ 26,65	€ 31,70	023 845 054 9	
845 AE	F4	3,0 m	V	€ 29,65	€ 35,30	023 845 052 9
				€ 32,65	€ 38,85	023 845 751 9
F16 RAL9005	3,0 m	V	€ 21,90	€ 26,05	023 845 044 9	
			€ 24,75	€ 29,45	023 845 042 9	
845 ER	F4	3,0 m	V	€ 27,30	€ 32,50	023 845 741 9
				€ 21,90	€ 26,05	023 845 064 9
F16 RAL9005	3,0 m	V	€ 24,75	€ 29,45	023 845 062 9	
			€ 27,30	€ 32,50	023 845 761 9	
845 EL	F4	3,0 m	V	€ 61,80	€ 73,55	323 846 004 8
				€ 66,00	€ 78,55	323 846 002 8
F16 RAL9005	3,0 m	V	€ 73,50	€ 87,45	323 846 701 8	
			€ 56,10	€ 66,75	323 844 004 8	
844	F4	3,0 m	V	€ 60,30	€ 71,75	323 844 002 8
				€ 130,80	€ 155,65	323 844 604 8
F16 RAL9005	3,0 m	V	€ 135,00	€ 160,65	323 844 602 8	
			€ 159,00	€ 189,20	323 844 761 8	
844 WS	F4	3,0 m	V	€ 65,70	€ 78,20	323 847 004 8
				€ 69,90	€ 83,20	323 847 002 8
F16 RAL9005	3,0 m	V	€ 79,50	€ 94,60	323 847 701 8	
			€ 28,15	€ 33,50	023 847 054 9	
847 AE	F4	3,0 m	V	€ 31,15	€ 37,05	023 847 052 9
				€ 34,15	€ 40,65	023 847 751 9
F16 RAL9005	3,0 m	V	€ 22,65	€ 26,95	023 847 044 9	
			€ 25,35	€ 30,15	023 847 042 9	
847 ER	F4	3,0 m	V	€ 28,05	€ 33,40	023 847 741 9
				€ 22,65	€ 26,95	023 847 064 9
F16 RAL9005	3,0 m	V	€ 25,35	€ 30,15	023 847 062 9	
			€ 28,05	€ 33,40	023 847 761 9	
847 EL	F4	3,0 m	V	€ 22,65	€ 26,95	023 847 064 9
				€ 25,35	€ 30,15	023 847 062 9
F16 RAL9005	3,0 m	V	€ 28,05	€ 33,40	023 847 761 9	

Artikel	Farben	Länge	Version	Preis/Stück	unit price	Bestell-Nr.
article	colour	length	version	exkl. MwSt.	inkl. MwSt.	order no.
859	F3	5,0 m	V	€ 71,00	€ 84,50	323 59 037
		2,5 m	V	€ 35,80	€ 42,60	323 59 034
F4		5,0 m	V	€ 71,00	€ 84,50	323 59 047
		2,5 m	V	€ 35,80	€ 42,60	323 59 044
F5		1,0 m	V	€ 14,80	€ 17,60	323 59 041
		5,0 m	V	€ 79,50	€ 94,60	323 59 057
F9		2,5 m	V	€ 40,00	€ 47,60	323 59 054
		5,0 m	V	€ 71,00	€ 84,50	323 59 097
F6		2,5 m	V	€ 35,80	€ 42,60	323 59 094
		5,0 m	V	€ 79,50	€ 94,60	323 59 067
F2		2,5 m	V	€ 40,00	€ 47,60	323 59 064
		5,0 m	V	€ 80,00	€ 95,20	323 59 027
F6		2,5 m	V	€ 40,00	€ 47,60	323 59 024
		1,0 m	V	€ 16,40	€ 19,50	323 59 021
860	F3	5,0 m	V	€ 72,00	€ 85,70	323 60 037
		2,5 m	V	€ 36,30	€ 43,20	323 60 034
F4		5,0 m	V	€ 72,00	€ 85,70	323 60 047
		2,5 m	V	€ 36,30	€ 43,20	323 60 044
F5		1,0 m	V	€ 15,10	€ 17,95	323 60 041
		5,0 m	V	€ 80,00	€ 95,20	323 60 057
F9		2,5 m	V	€ 40,30	€ 47,95	323 60 054
		5,0 m	V	€ 72,00	€ 85,70	323 60 097
F6		2,5 m	V	€ 36,30	€ 43,20	323 60 094
		5,0 m	V	€ 80,00	€ 95,20	323 60 067
F2		2,5 m	V	€ 40,30	€ 47,95	323 60 064
		5,0 m	V	€ 80,00	€ 95,20	323 60 027
F7		1,0 m	V	€ 16,60	€ 19,75	323 60 021
		5,0 m	V	€ 269,50	€ 320,70	323 60 077
862	F3	2,5 m	V	€ 135,00	€ 160,65	323 60 074
		5,0 m	V	€ 93,00	€ 110,65	323 62 037
F4		2,5 m	V	€ 46,80	€ 55,70	323 62 034
		5,0 m	V	€ 93,00	€ 110,65	323 62 047
F5		2,5 m	V	€ 46,80	€ 55,70	323 62 044
		1,0 m	V	€ 19,20	€ 22,85	323 62 041
F9		5,0 m	V	€ 105,00	€ 124,95	323 62 057
		2,5 m	V	€ 52,80	€ 62,85	323 62 054
F6		5,0 m	V	€ 93,00	€ 110,65	323 62 097
		2,5 m	V	€ 46,80	€ 55,70	323 62 094
F2		5,0 m	V	€ 105,00	€ 124,95	323 62 067
		2,5 m	V	€ 52,80	€ 62,85	323 62 064
861	F3	1,0 m	V	€ 21,60	€ 25,70	323 62 021
		5,0 m	V	€ 73,50	€ 87,45	323 61 037
F4		2,5 m	V	€ 37,00	€ 44,05	323 61 034
		5,0 m	V	€ 73,50	€ 87,45	323 61 047
F5		2,5 m	V	€ 37,00	€ 44,05	323 61 044
		5,0 m	V	€ 81,50	€ 97,00	323 61 057
F9		2,5 m	V	€ 41,00	€ 48,80	323 61 054
		5,0 m	V	€ 73,50	€ 87,45	323 61 097
F6		2,5 m	V	€ 37,00	€ 44,05	323 61 094
		5,0 m	V	€ 81,50	€ 97,00	323 61 067
863	F3	2,5 m	V	€ 41,00	€ 48,80	323 61 064
		5,0 m	V	€ 81,50	€ 97,00	323 61 027
F4		2,5 m	V	€ 41,00	€ 48,80	323 61 024
		5,0 m	V	€ 75,50	€ 89,85	323 63 037
F5		2,5 m	V	€ 38,00	€ 45,20	323 63 034
		5,0 m	V	€ 75,50	€ 89,85	323 63 047
F9		2,5 m	V	€ 38,00	€ 45,20	323 63 044
		5,0 m	V	€ 82,50	€ 98,20	323 63 057
F6		2,5 m	V	€ 41,50	€ 49,40	323 63 054
		5,0 m	V	€ 75,50	€ 89,85	323 63 097
864	F3	2,5 m	V	€ 38,00	€ 45,20	323 63 094
		5,0 m	V	€ 82,50	€ 98,20	323 63 067
F4		2,5 m	V	€ 41,50	€ 49,40	323 63 064
		5,0 m	V	€ 82,50	€ 98,20	323 63 027
F2		2,5 m	V	€ 41,50	€ 49,40	323 63 024
		5,0 m	V	€ 77,00	€ 91,65	323 64 037
865	F3	2,5 m	V	€ 38,80	€ 46,15	323 64 034
		5,0 m	V	€ 77,00	€ 91,65	323 64 047
F4		2,5 m	V	€ 38,80	€ 46,15	323 64 044
		5,0 m	V	€ 83,50	€ 99,35	323 64 057
F5		2,5 m	V	€ 42,00	€ 50,00	323 64 054
		5,0 m	V	€ 77,00	€ 91,65	323 64 097
F9		2,5 m	V	€ 38,80	€ 46,15	323 64 094
		5,0 m	V	€ 83,50	€ 99,35	323 64 067
F6		2,5 m	V	€ 42,00	€ 50,00	323 64 064
		5				

Treppenkanten- und Winkelprofile / Stair Nosings and Angle Edges

Artikel	Farben	Länge	Version	Preis/Stück	unit price	Bestell-Nr.	
article	colour	length	version	exkl. MwSt.	inkl. MwSt.	order no.	
F9	5,0 m	V	€ 96,50	€ 114,85	323 865 009 7		
		V	€ 48,50	€ 57,70	323 865 009 4		
	F6	5,0 m	V	€ 109,00	€ 129,70	323 865 006 7	
		2,5 m	V	€ 54,80	€ 65,20	323 865 006 4	
	F2	5,0 m	V	€ 109,00	€ 129,70	323 865 002 7	
		2,5 m	V	€ 54,80	€ 65,20	323 865 002 4	
866	F3	5,0 m	V	€ 103,00	€ 122,55	323 866 003 7	
		2,5 m	V	€ 51,80	€ 61,65	323 866 003 4	
	F4	5,0 m	V	€ 103,00	€ 122,55	323 866 004 7	
		2,5 m	V	€ 51,80	€ 61,65	323 866 004 4	
	F5	5,0 m	V	€ 115,00	€ 136,85	323 866 005 7	
		2,5 m	V	€ 57,80	€ 68,80	323 866 005 4	
	F9	5,0 m	V	€ 103,00	€ 122,55	323 866 009 7	
		2,5 m	V	€ 51,80	€ 61,65	323 866 009 4	
	F6	5,0 m	V	€ 115,00	€ 136,85	323 866 006 7	
		2,5 m	V	€ 57,80	€ 68,80	323 866 006 4	
	F2	5,0 m	V	€ 115,00	€ 136,85	323 866 002 7	
		2,5 m	V	€ 57,80	€ 68,80	323 866 002 4	
	870	F3	5,0 m	V	€ 80,50	€ 95,80	323 70 037
			2,5 m	V	€ 40,50	€ 48,20	323 70 034
		F4	5,0 m	V	€ 80,50	€ 95,80	323 70 047
			2,5 m	V	€ 40,50	€ 48,20	323 70 044
			1,0 m	V	€ 16,70	€ 19,85	323 70 041
			F5	5,0 m	V	€ 89,50	€ 106,50
		2,5 m	V	€ 45,00	€ 53,55	323 70 054	
		F9	5,0 m	V	€ 80,50	€ 95,80	323 70 097
		2,5 m	V	€ 40,50	€ 48,20	323 70 094	
		F6	5,0 m	V	€ 89,50	€ 106,50	323 70 067
		2,5 m	V	€ 45,00	€ 53,55	323 70 064	
		F2	5,0 m	V	€ 89,50	€ 106,50	323 70 027
2,5 m			V	€ 45,00	€ 53,55	323 70 024	
		1,0 m	V	€ 18,50	€ 22,00	323 70 021	
		871	F3	5,0 m	V	€ 81,50	€ 97,00
2,5 m				V	€ 41,00	€ 48,80	323 71 034
F4			5,0 m	V	€ 81,50	€ 97,00	323 71 047
			2,5 m	V	€ 41,00	€ 48,80	323 71 044
	1,0 m		V	€ 16,90	€ 20,10	323 71 041	
	F5		5,0 m	V	€ 90,50	€ 107,70	323 71 057
	2,5 m		V	€ 45,50	€ 54,15	323 71 054	
	F9		5,0 m	V	€ 81,50	€ 97,00	323 71 097
	2,5 m		V	€ 41,00	€ 48,80	323 71 094	
	F6		5,0 m	V	€ 90,50	€ 107,70	323 71 067
2,5 m			V	€ 45,50	€ 54,15	323 71 064	
	F2		5,0 m	V	€ 90,50	€ 107,70	323 71 027
	2,5 m		V	€ 45,50	€ 54,15	323 71 024	
	1,0 m		V	€ 18,70	€ 22,25	323 71 021	
	872		F3	5,0 m	V	€ 84,50	€ 100,55
2,5 m				V	€ 42,50	€ 50,60	323 872 003 4
F4			5,0 m	V	€ 84,50	€ 100,55	323 872 004 7
			2,5 m	V	€ 42,50	€ 50,60	323 872 004 4
F5		5,0 m	V	€ 92,50	€ 110,10	323 872 005 7	
		2,5 m	V	€ 46,50	€ 55,35	323 872 005 4	
F9		5,0 m	V	€ 84,50	€ 100,55	323 872 009 7	
		2,5 m	V	€ 42,50	€ 50,60	323 872 009 4	
F6		5,0 m	V	€ 92,50	€ 110,10	323 872 006 7	
		2,5 m	V	€ 46,50	€ 55,35	323 872 006 4	
F2		5,0 m	V	€ 92,50	€ 110,10	323 872 002 7	
		2,5 m	V	€ 46,50	€ 55,35	323 872 002 4	
873		F3	5,0 m	V	€ 89,00	€ 105,90	323 73 037
			2,5 m	V	€ 44,80	€ 53,30	323 73 034
		F4	5,0 m	V	€ 89,00	€ 105,90	323 73 047
			2,5 m	V	€ 44,80	€ 53,30	323 73 044
		F5	5,0 m	V	€ 95,00	€ 113,05	323 73 057
			2,5 m	V	€ 47,80	€ 56,90	323 73 054
	F9	5,0 m	V	€ 89,00	€ 105,90	323 73 097	
		2,5 m	V	€ 44,80	€ 53,30	323 73 094	
	F6	5,0 m	V	€ 95,00	€ 113,05	323 73 067	
		2,5 m	V	€ 47,80	€ 56,90	323 73 064	
	F2	5,0 m	V	€ 95,00	€ 113,05	323 73 027	
		2,5 m	V	€ 47,80	€ 56,90	323 73 024	
	874	F4	5,0 m	V	€ 95,50	€ 113,65	323 74 047
			2,5 m	V	€ 48,00	€ 57,10	323 74 044
			1,0 m	V	€ 19,70	€ 23,45	323 74 041
			F5	5,0 m	V	€ 106,00	€ 126,15
			2,5 m	V	€ 53,30	€ 63,45	323 74 054
			F9	5,0 m	V	€ 95,50	€ 113,65
		2,5 m	V	€ 48,00	€ 57,10	323 74 094	
		F6	5,0 m	V	€ 106,00	€ 126,15	323 74 067
		2,5 m	V	€ 53,30	€ 63,45	323 74 064	
		F2	5,0 m	V	€ 106,00	€ 126,15	323 74 027
2,5 m			V	€ 53,30	€ 63,45	323 74 024	
		1,0 m	V	€ 21,80	€ 25,95	323 74 021	
		875	F4	5,0 m	V	€ 105,50	€ 125,55
2,5 m				V	€ 53,00	€ 63,05	323 75 044

Artikel	Farben	Länge	Version	Preis/Stück	unit price	Bestell-Nr.	
article	colour	length	version	exkl. MwSt.	inkl. MwSt.	order no.	
F5	5,0 m	V	€ 115,00	€ 136,85	323 75 057		
		V	€ 57,80	€ 68,80	323 75 054		
	F9	5,0 m	V	€ 105,50	€ 125,55	323 75 097	
		2,5 m	V	€ 53,00	€ 63,05	323 75 094	
	F6	5,0 m	V	€ 115,00	€ 136,85	323 75 067	
		2,5 m	V	€ 57,80	€ 68,80	323 75 064	
F2	5,0 m	V	€ 115,00	€ 136,85	323 75 027		
	2,5 m	V	€ 57,80	€ 68,80	323 75 024		
	870 IW	F4	5,0 m	V	€ 63,00	€ 74,95	323 870 804 7
2,5 m			V	€ 31,80	€ 37,85	323 870 804 4	
F5		5,0 m	V	€ 69,50	€ 82,70	323 870 805 7	
		2,5 m	V	€ 35,00	€ 41,65	323 870 805 4	
F9		5,0 m	V	€ 63,00	€ 74,95	323 870 809 7	
		2,5 m	V	€ 31,80	€ 37,85	323 870 809 4	
F6		5,0 m	V	€ 69,50	€ 82,70	323 870 806 7	
		2,5 m	V	€ 35,00	€ 41,65	323 870 806 4	
F2		5,0 m	V	€ 69,50	€ 82,70	323 870 802 7	
		2,5 m	V	€ 35,00	€ 41,65	323 870 802 4	
871 IW		F4	5,0 m	V	€ 63,50	€ 75,55	323 871 804 7
			2,5 m	V	€ 32,00	€ 38,10	323 871 804 4
		F5	5,0 m	V	€ 70,50	€ 83,90	323 871 805 7
			2,5 m	V	€ 35,50	€ 42,25	323 871 805 4
		F9	5,0 m	V	€ 63,50	€ 75,55	323 871 809 7
			2,5 m	V	€ 32,00	€ 38,10	323 871 809 4
		F6	5,0 m	V	€ 70,50	€ 83,90	323 871 806 7
			2,5 m	V	€ 35,50	€ 42,25	323 871 806 4
	F2	5,0 m	V	€ 70,50	€ 83,90	323 871 802 7	
		2,5 m	V	€ 35,50	€ 42,25	323 871 802 4	
	877 IW	F4	5,0 m	V	€ 64,50	€ 76,75	323 877 804 7
			2,5 m	V	€ 32,50	€ 38,70	323 877 804 4
		F5	5,0 m	V	€ 71,50	€ 85,10	323 877 802 7
			2,5 m	V	€ 36,00	€ 42,85	323 877 802 4

Runde Ecken Round Corner

859 EC	F4	0,3 m	V	€ 85,50	€ 101,75	223 859 034 9
859 EC-R	F4	1,0 m	V	€ 103,05	€ 122,65	223 859 024 9
859 EC-R	F4	1,5 m	V	€ 110,70	€ 131,75	223 859 084 9
859 EC-L	F4	1,0 m	V	€ 103,05	€ 122,65	223 859 014 9
859 EC-L	F4	1,5 m	V	€ 110,70	€ 131,75	223 859 074 9
860 EC	F4	0,3 m	V	€ 87,10	€ 103,65	223 860 034 9
860 EC-R	F4	1,0 m	V	€ 104,65	€ 124,55	223 860 024 9
860 EC-R	F4	1,5 m	V	€ 112,20	€ 133,50	223 860 084 9
860 EC-L	F4	1,0 m	V	€ 104,65	€ 124,55	223 860 014 9
860 EC-L	F4	1,5 m	V	€ 112,20	€ 133,50	223 860 074 9
862 EC	F4	0,3 m	V	€ 90,10	€ 107,20	223 862 034 9
862 EC-R	F4	1,0 m	V	€ 107,65	€ 128,10	223 862 024 9
862 EC-R	F4	1,5 m	V	€ 115,30	€ 137,20	223 862 084 9
862 EC-L	F4	1,0 m	V	€ 107,65	€ 128,10	223 862 014 9
862 EC-L	F4	1,5 m	V	€ 115,30	€ 137,20	223 862 074 9
870 EC	F4	0,3 m	V	€ 87,10	€ 103,65	223 870 034 9
870 EV	F4	0,3 m	V	€ 124,45	€ 148,10	223 870 044 9
870 EC-R	F4	1,0 m	V	€ 104,65	€ 124,55	223 870 024 9
870 EC-R	F4	1,5 m	V	€ 112,20	€ 133,50	223 870 084 9
870 EV-R	F4	1,0 m	V	€ 142,00	€ 169,00	223 870 064 9
870 EV-R	F4	1,5 m	V	€ 149,65	€ 178,10	223 870 104 9
870 EC-L	F4	1,0 m	V	€ 104,65	€ 124,55	223 870 014 9
870 EC-L	F4	1,5 m	V	€ 112,20	€ 133,50	223 870 074 9
870 EV-L	F4	1,0 m	V	€ 142,00	€ 169,00	223 870 054 9
870 EV-L	F4	1,5 m	V	€ 149,65	€ 178,10	223 870 094 9
871 EC	F4	0,3 m	V	€ 88,60	€ 105,45	223 871 034 9
871 EV	F4	0,3 m	V	€ 126,00	€ 149,95	223 871 044 9
871 EC-R	F4	1,0 m	V	€ 106,15	€ 126,30	223 871 024 9
871 EC-R	F4	1,5 m	V	€ 113,80	€ 135,40	223 871 084 9
871 EV-R	F4	1,0 m	V	€ 143,55	€ 170,80	223 871 064 9
871 EV-R	F4	1,5 m	V	€ 151,20	€ 179,95	223 871 104 9
871 EC-L	F4	1,0 m	V	€ 106,15	€ 126,30	223 871 014 9
871 EC-L	F4	1,5 m	V	€ 113,80	€ 135,40	223 871 074 9
871 EV-L	F4	1,0 m	V	€ 143,55	€ 170,80	223 871 054 9
871 EV-L	F4	1,5 m	V	€ 151,20	€ 179,95	223 871 094 9
845 EC	F4	0,3 m	V	€ 89,95	€ 107,05	223 845 034 9
845 EC-R	F4	1,0 m	V	€ 104,95	€ 124,90	223 845 024 9
845 EC-L	F4	1,0 m	V	€ 104,95	€ 124,90	223 845 014 9</

Artikel	Farben	Länge	Version	Preis/Stück	unit price	Bestell-Nr.
article	colour	length	version	exkl. MwSt.	inkl. MwSt.	order no.

Treppenkantenprofile mit LED-Leuchten Stair Nosings with LED Lights

890	F3	3,0 m	V	€ 100,80	€ 119,95	323 89 038
	F4	3,0 m	V	€ 100,80	€ 119,95	323 89 048
	F5	3,0 m	V	€ 112,50	€ 133,90	323 89 058
	F9	3,0 m	V	€ 100,80	€ 119,95	323 89 098
	F6	3,0 m	V	€ 112,50	€ 133,90	323 89 068
	F2	3,0 m	V	€ 112,50	€ 133,90	323 89 028
891	F3	5,0 m	V	€ 127,00	€ 151,15	323 891 003 7
		2,5 m	V	€ 63,50	€ 75,55	323 891 003 4
	F4	5,0 m	V	€ 127,00	€ 151,15	323 891 004 7
		2,5 m	V	€ 63,50	€ 75,55	323 891 004 4
	F5	5,0 m	V	€ 140,00	€ 166,60	323 891 005 7
		2,5 m	V	€ 70,00	€ 83,30	323 891 005 4
	F9	5,0 m	V	€ 127,00	€ 151,15	323 891 009 7
		2,5 m	V	€ 63,50	€ 75,55	323 891 009 4
	F6	5,0 m	V	€ 140,00	€ 166,60	323 891 006 7
		2,5 m	V	€ 70,00	€ 83,30	323 891 006 4
	F2	5,0 m	V	€ 140,00	€ 166,60	323 891 002 7
		2,5 m	V	€ 70,00	€ 83,30	323 891 002 4

Zubehör LED / LED Accessories

899	weiß	10,0 m		€ 524,25	€ 623,85	123 891 999 9
	weiß	2,5 m		€ 146,25	€ 174,05	123 891 999 4
	weiß	1,0 m		€ 74,25	€ 88,35	123 891 999 1
895 V		1,5 m		€ 23,05	€ 27,45	123 891 995 4
895 L		1 Set		€ 17,25	€ 20,55	123 891 995 5
894	klar	2,0 m		€ 15,90	€ 18,90	123 891 991 3
	blau	2,0 m		€ 15,90	€ 18,90	123 891 992 3
	rot	2,0 m		€ 15,90	€ 18,90	123 891 993 3
	milchig	2,0 m		€ 20,10	€ 23,90	123 891 994 3
898	weiß	10,0 m		€ 149,25	€ 177,60	123 891 998 9
	weiß	2,5 m		€ 46,35	€ 55,15	123 891 998 4
	weiß	1,0 m		€ 21,75	€ 25,90	123 891 998 1
896		1 Stück		€ 52,35	€ 62,30	123 891 996 9
897		1 Stück		€ 209,85	€ 249,70	123 891 997 9
893		1 Stück		€ 329,95	€ 392,65	123 893 995 9



Treppenläuferstangen und Türstopper Stairrods and Door Stoppers

Artikel	Farben	Länge	Version	Preis/Stück	unit price	Bestell-Nr.
article	colour	length	version	exkl. MwSt.	inkl. MwSt.	order no.

730 Treppenstangen mit Eichelknöpfen, hohl stairrods with endstops, hollow

9 mm Ø	F7	0,70 m		€ 14,50	€ 17,25	048 00 018
9 mm Ø	F7	0,75 m		€ 15,20	€ 18,10	048 00 028
9 mm Ø	F7	0,80 m		€ 15,80	€ 18,80	048 00 038
11 mm Ø	F7	0,70 m		€ 15,50	€ 18,45	048 00 048
11 mm Ø	F7	0,75 m		€ 16,30	€ 19,40	048 00 058
11 mm Ø	F7	0,80 m		€ 17,10	€ 20,35	048 00 068
11 mm Ø	F7	0,90 m		€ 18,70	€ 22,25	048 00 089
11 mm Ø	F7	1,00 m		€ 20,10	€ 23,90	048 00 078

Artikel	Farben	Länge	Version	Preis/Stück	unit price	Bestell-Nr.
article	colour	length	version	exkl. MwSt.	inkl. MwSt.	order no.

9 mm Ø	F71	0,70 m		€ 18,70	€ 22,25	048 00 108
9 mm Ø	F71	0,75 m		€ 19,50	€ 23,20	048 00 118
9 mm Ø	F71	0,80 m		€ 20,60	€ 24,50	048 00 128
11 mm Ø	F71	0,75 m		€ 20,40	€ 24,30	048 00 148
11 mm Ø	F71	0,80 m		€ 21,50	€ 25,60	048 00 158
11 mm Ø	F71	1,00 m		€ 25,00	€ 29,75	048 00 168
9 mm Ø	F72	0,70 m		€ 21,70	€ 25,80	048 00 908
9 mm Ø	F72	0,75 m		€ 22,70	€ 27,00	048 00 918
9 mm Ø	F72	0,80 m		€ 24,00	€ 28,55	048 00 928
11 mm Ø	F72	0,75 m		€ 23,80	€ 28,30	048 00 938
11 mm Ø	F72	0,80 m		€ 25,00	€ 29,75	048 00 948
11 mm Ø	F72	1,00 m		€ 29,00	€ 34,50	048 00 958

731 Winkelöse, seitlich offen Stairrod clip, laterally open

für 9 mm Ø	F7		€ 7,40	€ 8,80	048 00 208
für 11 mm Ø	F7		€ 7,60	€ 9,05	048 00 218
für 13 mm Ø	F7		€ 11,20	€ 13,35	048 013 005 8
für 9 mm Ø	F71		€ 8,75	€ 10,40	048 00 228
für 11 mm Ø	F71		€ 10,20	€ 12,15	048 00 238
für 13 mm Ø	F71		€ 10,60	€ 12,60	048 013 004 8
für 9 mm Ø	F72		€ 9,00	€ 10,70	048 00 268
für 11 mm Ø	F72		€ 9,00	€ 10,70	048 00 288
für 13 mm Ø	F72		€ 11,20	€ 13,35	048 013 002 8
für 9 mm Ø	F73		€ 10,60	€ 12,60	048 009 006 8
für 11 mm Ø	F73		€ 10,90	€ 12,95	048 011 006 8
für 13 mm Ø	F73		€ 12,90	€ 15,35	048 013 006 8
für 9 mm Ø	F74		€ 10,00	€ 11,90	048 009 011 8
für 11 mm Ø	F74		€ 12,35	€ 14,70	048 011 011 8
für 13 mm Ø	F74		€ 14,35	€ 17,10	048 013 011 8

732 Ringöse mit Madenschraube und eingeklebter Stockschrabe Stairrod eye with glued stair bolt

für 9 mm Ø	F7		€ 3,00	€ 3,55	048 00 308
für 11 mm Ø	F7		€ 4,00	€ 4,75	048 00 318
für 13 mm Ø	F7		€ 5,80	€ 6,90	048 013 605 8
für 9 mm Ø	F71		€ 3,60	€ 4,30	048 00 328
für 11 mm Ø	F71		€ 4,40	€ 5,25	048 00 338
für 13 mm Ø	F71		€ 6,20	€ 7,40	048 013 604 8
für 9 mm Ø	F72		€ 3,60	€ 4,30	048 00 368
für 11 mm Ø	F72		€ 4,40	€ 5,25	048 00 388
für 13 mm Ø	F72		€ 6,20	€ 7,40	048 013 603 8
für 9 mm Ø	F73		€ 3,70	€ 4,40	048 009 606 8
für 11 mm Ø	F73		€ 4,60	€ 5,45	048 011 606 8
für 13 mm Ø	F73		€ 6,40	€ 7,60	048 013 606 8
für 9 mm Ø	F74		€ 3,70	€ 4,40	048 009 611 8
für 11 mm Ø	F74		€ 4,60	€ 5,45	048 011 611 8
für 13 mm Ø	F74		€ 6,40	€ 7,60	048 013 611 8

733 Treppenstangen mit Eichelknöpfen, mit Stahlkern Stairrods with endstops, with steel core

9 mm Ø	F7	0,60 m		€ 15,60	€ 18,55	048 09 019
9 mm Ø	F7	0,65 m		€ 16,40	€ 19,50	048 09 010
9 mm Ø	F7	0,70 m		€ 17,10	€ 20,35	048 09 011
9 mm Ø	F7	0,75 m		€ 18,00	€ 21,40	048 09 012
9 mm Ø	F7	0,80 m		€ 18,80	€ 22,35	048 09 013
9 mm Ø	F7	0,90 m		€ 20,40	€ 24,30	048 09 014
9 mm Ø	F7	1,00 m		€ 22,00	€ 26,20	048 09 015
9 mm Ø	F7	1,05 m		€ 22,70	€ 27,00	048 09 016
11 mm Ø	F7	0,60 m		€ 17,50	€ 20,85	048 11 019
11 mm Ø	F7	0,65 m		€ 18,20	€ 21,65	048 11 010
11 mm Ø	F7	0,70 m		€ 19,00	€ 22,60	048 11 011
11 mm Ø	F7	0,75 m		€ 19,90	€ 23,70	048 11 012
11 mm Ø	F7	0,80 m		€ 21,00	€ 25,00	048 11 013
11 mm Ø	F7	0,90 m		€ 22,60	€ 26,90	048 11 014
11 mm Ø	F7	1,00 m		€ 24,60	€ 29,25	048 11 015
11 mm Ø	F7	1,05 m		€ 25,50	€ 30,35	048 11 016
11 mm Ø	F7	1,10 m		€ 26,50	€ 31,55	048 11 017
13 mm Ø	F7	0,60 m		€ 21,70	€ 25,80	048 13 019
13 mm Ø	F7	0,65 m		€ 22,50	€ 26,80	048 13 010
13 mm Ø	F7	0,70 m		€ 23,60	€ 28,10	048 13 011
13 mm Ø	F7	0,75 m		€ 24,70	€ 29,40	048 13 012
13 mm Ø	F7	0,80 m		€ 25,80	€ 30,70	048 13 013
13 mm Ø	F7	0,90 m		€ 28,30	€ 33,70	048 13 014
13 mm Ø	F7	1,00 m		€ 30,60	€ 36,40	048 13 015
13 mm Ø	F7	1,00 m		€ 31,90	€ 37,95	048 13 016
13 mm Ø	F7	1,00 m		€ 33,10	€ 39,40	048 13 017
9 mm Ø	F71	0,60 m		€ 19,40	€ 23,10	048 09 029
9 mm Ø	F71	0,65 m		€ 20,40	€ 24,30	048 09 020
9 mm Ø	F71	0,70 m		€ 21,50	€ 25,60	048 09 021
9 mm Ø	F71	0,75 m		€ 22,70	€ 27,00	048 09 022
9 mm Ø	F71	0,80 m		€ 24,00	€ 28,55	048 09 023

Treppenläuferstangen und Türstopper / Stairrods and Door Stoppers

Artikel	Farben	Länge	Version	Preis/Stück	unit price	Bestell-Nr.
article	colour	length	version	exkl. MwSt.	inkl. MwSt.	order no.
9 mm Ø	F71	0,90 m		€ 25,80	€ 30,70	048 09 024
9 mm Ø	F71	1,00 m		€ 28,00	€ 33,30	048 09 025
9 mm Ø	F71	1,05 m		€ 29,00	€ 34,50	048 09 026
11 mm Ø	F71	0,60 m		€ 21,30	€ 25,35	048 11 029
11 mm Ø	F71	0,65 m		€ 22,00	€ 26,20	048 11 020
11 mm Ø	F71	0,70 m		€ 22,80	€ 27,15	048 11 021
11 mm Ø	F71	0,75 m		€ 24,10	€ 28,70	048 11 022
11 mm Ø	F71	0,80 m		€ 25,00	€ 29,75	048 11 023
11 mm Ø	F71	0,90 m		€ 27,20	€ 32,35	048 11 024
11 mm Ø	F71	1,00 m		€ 29,60	€ 35,20	048 11 025
11 mm Ø	F71	1,05 m		€ 30,70	€ 36,55	048 11 026
11 mm Ø	F71	1,10 m		€ 31,80	€ 37,85	048 11 027
13 mm Ø	F71	0,60 m		€ 25,60	€ 30,45	048 13 029
13 mm Ø	F71	0,65 m		€ 26,80	€ 31,90	048 13 020
13 mm Ø	F71	0,70 m		€ 27,90	€ 33,20	048 13 021
13 mm Ø	F71	0,75 m		€ 29,00	€ 34,50	048 13 022
13 mm Ø	F71	0,80 m		€ 30,20	€ 35,95	048 13 023
13 mm Ø	F71	0,90 m		€ 33,00	€ 39,25	048 13 024
13 mm Ø	F71	1,00 m		€ 35,80	€ 42,60	048 13 025
9 mm Ø	F72	0,60 m		€ 22,10	€ 26,30	048 09 039
9 mm Ø	F72	0,65 m		€ 23,00	€ 27,35	048 09 030
9 mm Ø	F72	0,70 m		€ 24,30	€ 28,90	048 09 031
9 mm Ø	F72	0,75 m		€ 25,60	€ 30,45	048 09 032
9 mm Ø	F72	0,80 m		€ 27,00	€ 32,15	048 09 033
9 mm Ø	F72	0,90 m		€ 29,40	€ 35,00	048 09 034
9 mm Ø	F72	1,00 m		€ 32,00	€ 38,10	048 09 035
9 mm Ø	F72	1,05 m		€ 32,90	€ 39,15	048 09 036
11 mm Ø	F72	0,60 m		€ 23,00	€ 27,35	048 11 039
11 mm Ø	F72	0,65 m		€ 24,20	€ 28,80	048 11 030
11 mm Ø	F72	0,70 m		€ 25,40	€ 30,25	048 11 031
11 mm Ø	F72	0,75 m		€ 26,90	€ 32,00	048 11 032
11 mm Ø	F72	0,80 m		€ 28,30	€ 33,70	048 11 033
11 mm Ø	F72	0,90 m		€ 30,70	€ 36,55	048 11 034
11 mm Ø	F72	1,00 m		€ 33,30	€ 39,65	048 11 035
11 mm Ø	F72	1,05 m		€ 35,00	€ 41,65	048 11 036
11 mm Ø	F72	1,10 m		€ 36,10	€ 42,95	048 11 037
13 mm Ø	F72	0,60 m		€ 28,30	€ 33,70	048 13 039
13 mm Ø	F72	0,65 m		€ 29,60	€ 35,20	048 13 030
13 mm Ø	F72	0,70 m		€ 31,00	€ 36,90	048 13 031
13 mm Ø	F72	0,75 m		€ 32,40	€ 38,55	048 13 032
13 mm Ø	F72	0,80 m		€ 33,90	€ 40,35	048 13 033
13 mm Ø	F72	0,90 m		€ 37,10	€ 44,15	048 13 034
13 mm Ø	F72	1,00 m		€ 40,20	€ 47,85	048 13 035
9 mm Ø	F73	0,60 m		€ 28,30	€ 33,70	048 090 606 9
9 mm Ø	F73	0,65 m		€ 28,60	€ 34,05	048 090 606 0
9 mm Ø	F73	0,70 m		€ 29,10	€ 34,65	048 090 606 1
9 mm Ø	F73	0,75 m		€ 29,80	€ 35,45	048 090 606 2
9 mm Ø	F73	0,80 m		€ 30,70	€ 36,55	048 090 606 3
9 mm Ø	F73	0,90 m		€ 31,90	€ 37,95	048 090 606 4
9 mm Ø	F73	1,00 m		€ 33,60	€ 40,00	048 090 606 5
11 mm Ø	F73	0,60 m		€ 29,10	€ 34,65	048 110 606 9
11 mm Ø	F73	0,65 m		€ 30,10	€ 35,80	048 110 606 0
11 mm Ø	F73	0,70 m		€ 31,50	€ 37,50	048 110 606 1
11 mm Ø	F73	0,75 m		€ 32,30	€ 38,45	048 110 606 2
11 mm Ø	F73	0,80 m		€ 33,60	€ 40,00	048 110 606 3
11 mm Ø	F73	0,90 m		€ 36,10	€ 42,95	048 110 606 4
11 mm Ø	F73	1,00 m		€ 38,80	€ 46,15	048 110 606 5
13 mm Ø	F73	0,60 m		€ 34,30	€ 40,80	048 130 606 9
13 mm Ø	F73	0,65 m		€ 35,70	€ 42,50	048 130 606 0
13 mm Ø	F73	0,70 m		€ 37,00	€ 44,05	048 130 606 1
13 mm Ø	F73	0,75 m		€ 38,30	€ 45,60	048 130 606 2
13 mm Ø	F73	0,80 m		€ 39,80	€ 47,35	048 130 606 3
13 mm Ø	F73	0,90 m		€ 43,00	€ 51,15	048 130 606 4
13 mm Ø	F73	1,00 m		€ 46,10	€ 54,85	048 130 606 5
9 mm Ø	F74	0,60 m		€ 22,10	€ 26,30	048 090 011 9
9 mm Ø	F74	0,65 m		€ 23,00	€ 27,35	048 090 011 0
9 mm Ø	F74	0,70 m		€ 24,30	€ 28,90	048 090 011 1
9 mm Ø	F74	0,75 m		€ 25,60	€ 30,45	048 090 011 2
9 mm Ø	F74	0,80 m		€ 27,00	€ 32,15	048 090 011 3
9 mm Ø	F74	0,90 m		€ 29,40	€ 35,00	048 090 011 4
9 mm Ø	F74	1,00 m		€ 32,00	€ 38,10	048 090 011 5
11 mm Ø	F74	0,60 m		€ 23,00	€ 27,35	048 110 011 9
11 mm Ø	F74	0,65 m		€ 24,20	€ 28,80	048 110 011 0
11 mm Ø	F74	0,70 m		€ 25,40	€ 30,25	048 110 011 1
11 mm Ø	F74	0,75 m		€ 26,90	€ 32,00	048 110 011 2
11 mm Ø	F74	0,80 m		€ 28,30	€ 33,70	048 110 011 3
11 mm Ø	F74	0,90 m		€ 30,70	€ 36,55	048 110 011 4
11 mm Ø	F74	1,00 m		€ 33,30	€ 39,65	048 110 011 5
13 mm Ø	F74	0,60 m		€ 28,30	€ 33,70	048 130 011 9
13 mm Ø	F74	0,65 m		€ 29,60	€ 35,20	048 130 011 0
13 mm Ø	F74	0,70 m		€ 31,00	€ 36,90	048 130 011 1
13 mm Ø	F74	0,75 m		€ 32,40	€ 38,55	048 130 011 2
13 mm Ø	F74	0,80 m		€ 33,90	€ 40,35	048 130 011 3
13 mm Ø	F74	0,90 m		€ 37,10	€ 44,15	048 130 011 4
13 mm Ø	F74	1,00 m		€ 40,20	€ 47,85	048 130 011 5

Artikel	Farben	Länge	Version	Preis/Stück	unit price	Bestell-Nr.
article	colour	length	version	exkl. MwSt.	inkl. MwSt.	order no.
734	Treppenstangen ohne Eichelknöpfe, hohl Stairrods without endstops, hollow					
9 mm Ø	F7	5,00 m		€ 77,00	€ 91,65	048 00 508
9 mm Ø	F7	2,50 m		€ 38,80	€ 46,15	048 00 504
11 mm Ø	F7	5,00 m		€ 86,00	€ 102,35	048 00 518
11 mm Ø	F7	2,50 m		€ 43,30	€ 51,55	048 00 514
9 mm Ø	F71	2,50 m		€ 59,30	€ 70,55	048 00 528
11 mm Ø	F71	2,50 m		€ 63,50	€ 75,55	048 00 538
9 mm Ø	F71	2,50 m		€ 60,50	€ 72,00	048 00 548
11 mm Ø	F71	2,50 m		€ 64,50	€ 76,75	048 00 558
735	Eichelknöpfe end stops					
für 9 mm Ø	F7			€ 3,10	€ 3,70	048 00 708
für 11 mm Ø	F7			€ 3,30	€ 3,95	048 00 718
für 9 mm Ø	F71			€ 3,30	€ 3,95	048 00 728
für 11 mm Ø	F71			€ 3,50	€ 4,15	048 00 738
für 9 mm Ø	F72			€ 3,60	€ 4,30	048 00 748
für 11 mm Ø	F72			€ 3,90	€ 4,65	048 00 758
736	Dreikant Treppenstangen, hohl triangular stairrods, hollow					
16 mm	Stahl + F7	5,00 m		€ 182,50	€ 217,20	048 00 808
16 mm	steel + F7	2,50 m		€ 91,50	€ 108,90	048 00 804
16 mm	Stahl + F71	2,50 m		€ 109,50	€ 130,30	048 00 814
737	Dreikant Winkelöse, seitlich geschlossen Triangular stairrod clip, laterally closed					
16 mm	F7			€ 8,70	€ 10,35	048 00 858
16 mm	F71			€ 9,45	€ 11,25	048 00 868
738	Türstopper aus Messing, massiv Door stopper made of brass, solid					
Ø 31 mm	F71, Silber Optik silver optic			€ 26,95	€ 32,05	048 55 049
Ø 31 mm	F72, Edelstahl-Optik stainless steel optic			€ 26,95	€ 32,05	048 55 029
739	Aluminium Heizrohrrosette aluminium heating tube rosette					
für 15 mm Ø	F4			€ 18,90	€ 22,50	048 51 549
für 15 mm Ø	F2G			€ 22,65	€ 26,95	048 51 529
für 18 mm Ø	F4			€ 18,90	€ 22,50	048 51 849
für 18 mm Ø	F2G			€ 22,65	€ 26,95	048 51 829

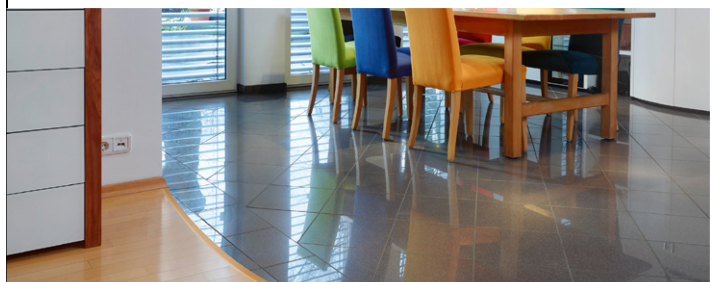

EB-Profil Easy Bending Profiles

Artikel	Farben	Länge	Version	Preis/Stück	unit price	Bestell-Nr.
article	colour	length	version	exkl. MwSt.	inkl. MwSt.	order no.
299	F0	2,5 m		€ 21,80	€ 25,95	219 99 004
	F3	2,5 m		€ 25,80	€ 30,70	219 99 034
	F4	2,5 m		€ 25,80	€ 30,70	219 99 044
	F5	2,5 m		€ 28,00	€ 33,30	219 99 054
	F9	2,5 m		€ 25,80	€ 30,70	219 99 094
	F6	2,5 m		€ 28,00	€ 33,30	219 99 064
	F2	2,5 m		€ 28,00	€ 33,30	219 99 024

Artikel	Farben	Länge	Version	Preis/Stück	unit price	Bestell-Nr.	Artikel	Farben	Länge	Version	Preis/Stück	unit price	Bestell-Nr.	
article	colour	length	version	exkl. MwSt.	inkl. MwSt.	order no.	article	colour	length	version	exkl. MwSt.	inkl. MwSt.	order no.	
	F0	2,5 m	G	€ 18,30	€ 21,80	219 99 104		F4	2,5 m	G	€ 22,00	€ 26,20	219 02 144	
	F3	2,5 m	G	€ 21,00	€ 25,00	219 99 134		F4	3,0 m	G	€ 26,40	€ 31,40	219 02 148	
	F4	2,5 m	G	€ 21,00	€ 25,00	219 99 144		F5	2,5 m	G	€ 23,80	€ 28,30	219 02 154	
	F5	2,5 m	G	€ 23,30	€ 27,75	219 99 154		F9	2,5 m	G	€ 22,00	€ 26,20	219 02 194	
	F9	2,5 m	G	€ 21,00	€ 25,00	219 99 194		F6	2,5 m	G	€ 23,80	€ 28,30	219 02 164	
	F6	2,5 m	G	€ 23,30	€ 27,75	219 99 164		F2	2,5 m	G	€ 23,80	€ 28,30	219 02 124	
	F2	2,5 m	G	€ 23,30	€ 27,75	219 99 124		F2	3,0 m	G	€ 28,50	€ 33,90	219 02 128	
	F15 RAL9016	2,5 m	G	€ 31,00	€ 36,90	219 299 715 4		F7	2,5 m	G	€ 57,30	€ 68,20	219 02 174	
	F16 RAL9005	2,5 m	G	€ 31,00	€ 36,90	219 299 711 4		F8	2,5 m	G	€ 39,30	€ 46,75	219 02 184	
	F0	2,5 m	U	€ 15,80	€ 18,80	219 99 204		F0	2,5 m	U	€ 16,30	€ 19,40	219 02 204	
	F3	2,5 m	U	€ 19,00	€ 22,60	219 99 234		F3	2,5 m	U	€ 20,00	€ 23,80	219 02 234	
	F4	2,5 m	U	€ 19,00	€ 22,60	219 99 244		F4	2,5 m	U	€ 20,00	€ 23,80	219 02 244	
	F5	2,5 m	U	€ 20,80	€ 24,75	219 99 254		F5	2,5 m	U	€ 21,80	€ 25,95	219 02 254	
	F9	2,5 m	U	€ 19,00	€ 22,60	219 99 294		F9	2,5 m	U	€ 20,00	€ 23,80	219 02 294	
	F6	2,5 m	U	€ 20,80	€ 24,75	219 99 264		F6	2,5 m	U	€ 21,80	€ 25,95	219 02 264	
	F2	2,5 m	U	€ 20,80	€ 24,75	219 99 224		F2	2,5 m	U	€ 21,80	€ 25,95	219 02 224	
	F15 RAL9016	2,5 m	U	€ 29,00	€ 34,50	219 299 725 4		302 S	F4+S10	2,5 m	S	€ 103,30	€ 122,95	219 02 344
	F16 RAL9005	2,5 m	U	€ 29,00	€ 34,50	219 299 721 4		F4+S10	3,0 m	S	€ 123,90	€ 147,45	219 302 034 8	
300	F0	2,5 m		€ 22,00	€ 26,20	219 00 004		F4+S20	2,5 m	S	€ 104,30	€ 124,10	219 302 134 4	
	F3	2,5 m		€ 26,30	€ 31,30	219 00 034		F9+S30	2,5 m	S	€ 106,50	€ 126,75	219 302 239 4	
	F4	2,5 m		€ 26,30	€ 31,30	219 00 044		F6+S40	2,5 m	S	€ 108,80	€ 129,45	219 302 336 4	
	F5	2,5 m		€ 28,30	€ 33,70	219 00 054		F8+S10	2,5 m	S	€ 142,30	€ 169,35	219 302 038 4	
	F9	2,5 m		€ 26,30	€ 31,30	219 00 094		F8+S20	2,5 m	S	€ 143,30	€ 170,55	219 302 138 4	
	F6	2,5 m		€ 28,30	€ 33,70	219 00 064		307	F0	2,5 m		€ 22,80	€ 27,15	219 07 004
	F2	2,5 m		€ 28,30	€ 33,70	219 00 024		F3	2,5 m		€ 27,50	€ 32,75	219 07 034	
	F0	2,5 m	G	€ 18,80	€ 22,35	219 00 104		F4	2,5 m		€ 27,50	€ 32,75	219 07 044	
	F3	2,5 m	G	€ 21,30	€ 25,35	219 00 134		F5	2,5 m		€ 29,50	€ 35,10	219 07 054	
	F4	2,5 m	G	€ 21,30	€ 25,35	219 00 144		F9	2,5 m		€ 27,50	€ 32,75	219 07 094	
	F5	2,5 m	G	€ 23,50	€ 27,95	219 00 154		F6	2,5 m		€ 29,50	€ 35,10	219 07 064	
	F9	2,5 m	G	€ 21,30	€ 25,35	219 00 194		F2	2,5 m		€ 29,50	€ 35,10	219 07 024	
	F6	2,5 m	G	€ 23,50	€ 27,95	219 00 164		F7	2,5 m		€ 67,00	€ 79,75	219 07 074	
	F2	2,5 m	G	€ 23,50	€ 27,95	219 00 124		F0	2,5 m	G	€ 19,30	€ 22,95	219 07 104	
	F0	2,5 m	U	€ 16,00	€ 19,05	219 00 204		F3	3,0 m	G	€ 23,10	€ 27,50	219 07 108	
	F3	2,5 m	U	€ 19,30	€ 22,95	219 00 234		F0	2,5 m	G	€ 22,50	€ 26,80	219 07 134	
	F4	2,5 m	U	€ 19,30	€ 22,95	219 00 244		F4	2,5 m	G	€ 22,50	€ 26,80	219 07 144	
	F5	2,5 m	U	€ 21,00	€ 25,00	219 00 254		F4	3,0 m	G	€ 27,00	€ 32,15	219 07 148	
	F9	2,5 m	U	€ 19,30	€ 22,95	219 00 294		F5	2,5 m	G	€ 24,80	€ 29,50	219 07 154	
	F6	2,5 m	U	€ 21,00	€ 25,00	219 00 264		F9	2,5 m	G	€ 22,50	€ 26,80	219 07 194	
	F2	2,5 m	U	€ 21,00	€ 25,00	219 00 224		F6	2,5 m	G	€ 24,80	€ 29,50	219 07 164	
300 S	F4+S10	2,5 m	S	€ 101,80	€ 121,15	219 300 034 4		F2	2,5 m	G	€ 24,80	€ 29,50	219 07 124	
301	F0	2,5 m		€ 22,00	€ 26,20	219 01 004		F2	3,0 m	G	€ 29,70	€ 35,35	219 07 128	
	F3	2,5 m		€ 26,80	€ 31,90	219 01 034		F7	2,5 m	G	€ 61,50	€ 73,20	219 07 174	
	F4	2,5 m		€ 26,80	€ 31,90	219 01 044		F8	2,5 m	G	€ 41,00	€ 48,80	219 07 184	
	F5	2,5 m		€ 28,50	€ 33,90	219 01 054		F0	2,5 m	U	€ 16,80	€ 20,00	219 07 204	
	F9	2,5 m		€ 26,80	€ 31,90	219 01 094		F3	2,5 m	U	€ 20,50	€ 24,40	219 07 234	
	F6	2,5 m		€ 28,50	€ 33,90	219 01 064		F4	2,5 m	U	€ 20,50	€ 24,40	219 07 244	
	F2	2,5 m		€ 28,50	€ 33,90	219 01 024		F5	2,5 m	U	€ 23,30	€ 27,75	219 07 254	
	F7	2,5 m		€ 58,30	€ 69,40	219 01 074		F9	2,5 m	U	€ 20,50	€ 24,40	219 07 294	
	F0	2,5 m	G	€ 18,50	€ 22,00	219 01 104		F6	2,5 m	U	€ 23,30	€ 27,75	219 07 264	
	F0	3,0 m	G	€ 22,20	€ 26,40	219 01 108		F2	2,5 m	U	€ 23,30	€ 27,75	219 07 224	
	F3	2,5 m	G	€ 21,50	€ 25,60	219 01 134		307 S	F4+S10	2,5 m	S	€ 104,30	€ 124,10	219 07 344
	F4	2,5 m	G	€ 21,50	€ 25,60	219 01 144		F4+S10	3,0 m	S	€ 125,10	€ 148,85	219 307 034 8	
	F4	3,0 m	G	€ 25,80	€ 30,70	219 01 148		F4+S20	2,5 m	S	€ 105,30	€ 125,30	219 307 134 4	
	F5	2,5 m	G	€ 23,00	€ 27,35	219 01 154		F9+S30	2,5 m	S	€ 108,30	€ 128,90	219 307 239 4	
	F9	2,5 m	G	€ 21,50	€ 25,60	219 01 194		F6+S40	2,5 m	S	€ 110,30	€ 131,25	219 307 336 4	
	F6	2,5 m	G	€ 23,00	€ 27,35	219 01 164		F8+S10	2,5 m	S	€ 145,50	€ 173,15	219 307 038 4	
	F2	2,5 m	G	€ 23,00	€ 27,35	219 01 124		F8+S20	2,5 m	S	€ 146,50	€ 174,35	219 307 138 4	
	F2	3,0 m	G	€ 27,60	€ 32,85	219 01 128		303	F0	2,5 m		€ 24,30	€ 28,90	219 03 004
	F7	2,5 m	G	€ 53,50	€ 63,65	219 01 174		F3	2,5 m		€ 28,30	€ 33,70	219 03 034	
	F8	2,5 m	G	€ 38,00	€ 45,20	219 01 184		F4	2,5 m		€ 28,30	€ 33,70	219 03 044	
	F0	2,5 m	U	€ 16,00	€ 19,05	219 01 204		F5	2,5 m		€ 31,00	€ 36,90	219 03 054	
	F3	2,5 m	U	€ 19,50	€ 23,20	219 01 234		F9	2,5 m		€ 28,30	€ 33,70	219 03 094	
	F4	2,5 m	U	€ 19,50	€ 23,20	219 01 244		F6	2,5 m		€ 31,00	€ 36,90	219 03 064	
	F5	2,5 m	U	€ 21,00	€ 25,00	219 01 254		F2	2,5 m		€ 31,00	€ 36,90	219 03 024	
	F9	2,5 m	U	€ 19,50	€ 23,20	219 01 294		F7	2,5 m		€ 71,50	€ 85,10	219 03 074	
	F6	2,5 m	U	€ 21,00	€ 25,00	219 01 264		F0	2,5 m	G	€ 20,30	€ 24,15	219 03 104	
	F2	2,5 m	U	€ 21,00	€ 25,00	219 01 224		F0	3,0 m	G	€ 24,30	€ 28,90	219 03 108	
301 S	F4+S10	2,5 m	S	€ 101,80	€ 121,15	219 301 034 4		F3	2,5 m	G	€ 24,30	€ 28,90	219 03 134	
	F4+S10	3,0 m	S	€ 122,10	€ 145,30	219 301 034 8		F4	2,5 m	G	€ 24,30	€ 28,90	219 03 144	
	F4+S20	2,5 m	S	€ 103,30	€ 122,95	219 301 134 4		F4	3,0 m	G	€ 29,10	€ 34,65	219 03 148	
	F9+S30	2,5 m	S	€ 105,30	€ 125,30	219 301 239 4		F5	2,5 m	G	€ 26,50	€ 31,55	219 03 154	
	F6+S40	2,5 m	S	€ 107,80	€ 128,30	219 301 336 4		F9	2,5 m	G	€ 24,30	€ 28,90	219 03 194	
	F8+S10	2,5 m	S	€ 139,00	€ 165,40	219 301 038 4		F6	2,5 m	G	€ 26,50	€ 31,55	219 03 164	
	F8+S20	2,5 m	S	€ 140,50	€ 167,20	219 301 138 4		F2	2,5 m	G	€ 26,50	€ 31,55	219 03 124	
302	F0	2,5 m		€ 22,30	€ 26,55	219 02 004		F2	3,0 m	G	€ 31,80	€ 37,85	219 03 128	
	F3	2,5 m		€ 27,00	€ 32,15	219 02 034		F7	2,5 m	G	€ 66,80	€ 79,50	219 03 174	
	F4	2,5 m		€ 27,00	€ 32,15	219 02 044		F8	2,5 m	G	€ 43,80	€ 52,10	219 03 184	
	F5	2,5 m		€ 28,80	€ 34,25	219 02 054		F0	2,5 m	U	€ 18,00	€ 21,40	219 03 204	
	F9	2,5 m		€ 27,00	€ 32,15	219 02 094		F3	2,5 m	U	€ 21,50	€ 25,60	219 03 234	
	F6	2,5 m		€ 28,80	€ 34,25	219 02 064		F4	2,5 m	U	€ 21,50	€ 25,60	219 03 244	
	F2	2,5 m		€ 28,80	€ 34,25	219 02 024		F2	2,5 m	U	€ 24,30	€ 28,90	219 03 224	
	F7	2,5 m		€ 62,50	€ 74,40	219 02 074		303 S	F4+S10	2,5 m	S	€ 107,50	€ 127,95	219 03 344
	F0	2,5 m	G	€ 18,80	€ 22,35	219 02 104		F4+S20	2,5 m	S	€ 108,50	€ 129,10	219 303 134 4	
	F0	3,0 m	G	€ 22,50	€ 26,80	219 02 108		F8+S10	2,5 m	S	€ 151,00	€ 179,70	219 303 038 4	
	F3	2,5 m	G	€ 22,00	€ 26,20	219 02 134		F8+S20	2,5 m	S	€ 152,00	€ 180,90	219 303 138 4	

EB-Profile / Easy Bending Profiles

Artikel	Farben	Länge	Version	SB	Preis/Stück	unit price	Bestell-Nr.
article	colour	length	version	SB	exkl. MwSt.	inkl. MwSt.	order no.
304	F0	2,5 m			€ 25,30	€ 30,10	219 04 004
	F3	2,5 m			€ 29,80	€ 35,45	219 04 034
	F4	2,5 m			€ 29,80	€ 35,45	219 04 044
	F5	2,5 m			€ 32,00	€ 38,10	219 04 054
	F9	2,5 m			€ 29,80	€ 35,45	219 04 094
	F6	2,5 m			€ 32,00	€ 38,10	219 04 064
	F2	2,5 m			€ 32,00	€ 38,10	219 04 024
	F7	2,5 m			€ 77,80	€ 92,60	219 04 074
	F0	2,5 m	G		€ 21,00	€ 25,00	219 04 104
	F3	2,5 m	G		€ 26,30	€ 31,30	219 04 134
	F4	2,5 m	G		€ 26,30	€ 31,30	219 04 144
	F5	2,5 m	G		€ 27,50	€ 32,75	219 04 154
	F9	2,5 m	G		€ 26,30	€ 31,30	219 04 194
	F6	2,5 m	G		€ 27,50	€ 32,75	219 04 164
	F2	2,5 m	G		€ 27,50	€ 32,75	219 04 124
	F7	2,5 m	G		€ 73,00	€ 86,85	219 04 174
	F8	2,5 m	G		€ 45,30	€ 53,90	219 04 184
	F0	2,5 m	U		€ 19,00	€ 22,60	219 04 204
	F3	2,5 m	U		€ 22,80	€ 27,15	219 04 234
	F4	2,5 m	U		€ 22,80	€ 27,15	219 04 244
	F2	2,5 m	U		€ 25,30	€ 30,10	219 04 224
	304 S	F4+S10	2,5 m	S		€ 109,00	€ 129,70
F4+S20		2,5 m	S		€ 110,00	€ 130,90	219 304 134 4
F8+S10		2,5 m	S		€ 154,50	€ 183,85	219 304 038 4
F8+S20		2,5 m	S		€ 155,50	€ 185,05	219 304 138 4
308	F0	2,5 m			€ 25,80	€ 30,70	219 08 004
	F4	2,5 m			€ 30,30	€ 36,05	219 08 044
	F5	2,5 m			€ 32,00	€ 38,10	219 08 054
	F9	2,5 m			€ 30,30	€ 36,05	219 08 094
	F6	2,5 m			€ 32,00	€ 38,10	219 08 064
	F2	2,5 m			€ 32,00	€ 38,10	219 08 024
	F0	2,5 m	G		€ 21,30	€ 25,35	219 08 104
	F3	2,5 m	G		€ 26,30	€ 31,30	219 08 134
	F4	2,5 m	G		€ 26,30	€ 31,30	219 08 144
	F5	2,5 m	G		€ 27,80	€ 33,10	219 08 154
	F9	2,5 m	G		€ 26,30	€ 31,30	219 08 194
	F6	2,5 m	G		€ 27,80	€ 33,10	219 08 164
	F2	2,5 m	G		€ 27,80	€ 33,10	219 08 124
	F0	2,5 m	U		€ 19,30	€ 22,95	219 08 204
	F3	2,5 m	U		€ 23,30	€ 27,75	219 08 234
	F4	2,5 m	U		€ 23,30	€ 27,75	219 08 244
	F2	2,5 m	U		€ 25,80	€ 30,70	219 08 224
	305	F0	2,5 m			€ 26,50	€ 31,55
F4		2,5 m			€ 30,50	€ 36,30	219 05 044
F5		2,5 m			€ 32,50	€ 38,70	219 05 054
F9		2,5 m			€ 30,50	€ 36,30	219 05 094
F6		2,5 m			€ 32,50	€ 38,70	219 05 064
F2		2,5 m			€ 32,50	€ 38,70	219 05 024
F7		2,5 m			€ 82,30	€ 97,95	219 05 074
F0		2,5 m	G		€ 21,80	€ 25,95	219 05 104
F3		2,5 m	G		€ 26,80	€ 31,90	219 05 134
F4		2,5 m	G		€ 26,80	€ 31,90	219 05 144
F5		2,5 m	G		€ 28,50	€ 33,90	219 05 154
F9		2,5 m	G		€ 26,80	€ 31,90	219 05 194
F6		2,5 m	G		€ 28,50	€ 33,90	219 05 164
F2		2,5 m	G		€ 28,50	€ 33,90	219 05 124
F7		2,5 m	G		€ 78,30	€ 93,20	219 05 174
F8		2,5 m	G		€ 47,30	€ 56,30	219 05 184
F0		2,5 m	U		€ 19,80	€ 23,55	219 05 204
F3		2,5 m	U		€ 23,50	€ 27,95	219 05 234
F4	2,5 m	U		€ 23,50	€ 27,95	219 05 244	
F2	2,5 m	U		€ 26,50	€ 31,55	219 05 224	
305 S	F4+S10	2,5 m	S		€ 110,00	€ 130,90	219 05 344
	F4+S20	2,5 m	S		€ 111,50	€ 132,70	219 305 134 4
311	F0	2,5 m			€ 26,80	€ 31,90	219 311 000 4
	F3	2,5 m			€ 31,00	€ 36,90	219 311 003 4
	F4	2,5 m			€ 31,00	€ 36,90	219 311 004 4
	F5	2,5 m			€ 33,00	€ 39,25	219 311 005 4
	F9	2,5 m			€ 31,00	€ 36,90	219 311 009 4
	F6	2,5 m			€ 33,00	€ 39,25	219 311 006 4
	F2	2,5 m			€ 33,00	€ 39,25	219 311 002 4
	F0	2,5 m	G		€ 22,00	€ 26,20	219 311 010 4
	F3	2,5 m	G		€ 27,00	€ 32,15	219 311 013 4
	F4	2,5 m	G		€ 27,00	€ 32,15	219 311 014 4
	F5	2,5 m	G		€ 28,80	€ 34,25	219 311 015 4
	F9	2,5 m	G		€ 27,00	€ 32,15	219 311 019 4
	F6	2,5 m	G		€ 28,80	€ 34,25	219 311 016 4
	F2	2,5 m	G		€ 28,80	€ 34,25	219 311 012 4
	F0	2,5 m	U		€ 20,00	€ 23,80	219 311 020 4
	F3	2,5 m	U		€ 24,30	€ 28,90	219 311 023 4
	F4	2,5 m	U		€ 24,30	€ 28,90	219 311 024 4
	F2	2,5 m	U		€ 26,50	€ 31,55	219 311 022 4
306	F0	2,5 m			€ 27,50	€ 32,75	219 06 004
	F3	2,5 m			€ 31,80	€ 37,85	219 06 034
	F4	2,5 m			€ 31,80	€ 37,85	219 06 044

Artikel	Farben	Länge	Version	SB	Preis/Stück	unit price	Bestell-Nr.
article	colour	length	version	SB	exkl. MwSt.	inkl. MwSt.	order no.
	F5	2,5 m			€ 34,00	€ 40,45	219 06 054
	F9	2,5 m			€ 31,80	€ 37,85	219 06 094
	F6	2,5 m			€ 34,00	€ 40,45	219 06 064
	F2	2,5 m			€ 34,00	€ 40,45	219 06 024
	F7	2,5 m			€ 87,30	€ 103,90	219 06 074
	F0	2,5 m	G		€ 22,50	€ 26,80	219 06 104
	F3	2,5 m	G		€ 27,80	€ 33,10	219 06 134
	F4	2,5 m	G		€ 27,80	€ 33,10	219 06 144
	F5	2,5 m	G		€ 29,50	€ 35,10	219 06 154
	F9	2,5 m	G		€ 27,80	€ 33,10	219 06 194
	F6	2,5 m	G		€ 29,50	€ 35,10	219 06 164
	F2	2,5 m	G		€ 29,50	€ 35,10	219 06 124
	F7	2,5 m	G		€ 83,00	€ 98,75	219 06 174
	F8	2,5 m	G		€ 50,00	€ 59,50	219 06 184
	F0	2,5 m	U		€ 20,50	€ 24,40	219 06 204
	F3	2,5 m	U		€ 25,00	€ 29,75	219 06 234
	F4	2,5 m	U		€ 25,00	€ 29,75	219 06 244
	F2	2,5 m	U		€ 27,30	€ 32,50	219 06 224
306 S	F4+S10	2,5 m	S		€ 112,00	€ 133,30	219 06 344
	F4+S20	2,5 m	S		€ 113,50	€ 135,05	219 306 134 4
312	F0	2,5 m			€ 27,80	€ 33,10	219 312 000 4
	F3	2,5 m			€ 32,50	€ 38,70	219 312 003 4
	F4	2,5 m			€ 32,50	€ 38,70	219 312 004 4
	F5	2,5 m			€ 35,30	€ 42,00	219 312 005 4
	F9	2,5 m			€ 32,50	€ 38,70	219 312 009 4
	F6	2,5 m			€ 35,30	€ 42,00	219 312 006 4
	F2	2,5 m			€ 35,30	€ 42,00	219 312 002 4
	F0	2,5 m	G		€ 23,50	€ 27,95	219 312 010 4
	F3	2,5 m	G		€ 29,00	€ 34,50	219 312 013 4
	F4	2,5 m	G		€ 29,00	€ 34,50	219 312 014 4
	F5	2,5 m	G		€ 31,00	€ 36,90	219 312 015 4
	F9	2,5 m	G		€ 29,00	€ 34,50	219 312 019 4
	F6	2,5 m	G		€ 31,00	€ 36,90	219 312 016 4
	F2	2,5 m	G		€ 31,00	€ 36,90	219 312 012 4
	F0	2,5 m	U		€ 21,00	€ 25,00	219 312 020 4
	F3	2,5 m	U		€ 26,30	€ 31,30	219 312 023 4
	F4	2,5 m	U		€ 26,30	€ 31,30	219 312 024 4
	F2	2,5 m	U		€ 29,00	€ 34,50	219 312 022 4
313	F0	2,5 m			€ 28,30	€ 33,70	219 313 000 4
	F4	2,5 m			€ 33,30	€ 39,65	219 313 004 4
	F5	2,5 m			€ 35,80	€ 42,60	219 313 005 4
	F9	2,5 m			€ 33,30	€ 39,65	219 313 009 4
	F6	2,5 m			€ 35,80	€ 42,60	219 313 006 4
	F2	2,5 m			€ 35,80	€ 42,60	219 313 002 4
	F0	2,5 m	G		€ 24,50	€ 29,15	219 313 010 4
	F3	2,5 m	G		€ 29,80	€ 35,45	219 313 013 4
	F4	2,5 m	G		€ 29,80	€ 35,45	219 313 014 4
	F5	2,5 m	G		€ 32,00	€ 38,10	219 313 015 4
	F9	2,5 m	G		€ 29,80	€ 35,45	219 313 019 4
	F6	2,5 m	G		€ 32,00	€ 38,10	219 313 016 4
	F2	2,5 m	G		€ 32,00	€ 38,10	219 313 012 4
	F0	2,5 m	U		€ 21,50	€ 25,60	219 313 020 4
	F3	2,5 m	U		€ 26,80	€ 31,90	219 313 023 4
	F4	2,5 m	U		€ 26,80	€ 31,90	219 313 024 4
	F2	2,5 m	U		€ 29,50	€ 35,10	219 313 022 4
	309	F0	2,5 m			€ 29,00	€ 34,50
F4		2,5 m			€ 34,30	€ 40,80	219 09 044
F5		2,5 m			€ 36,80	€ 43,80	219 09 054
F9		2,5 m			€ 34,30	€ 40,80	219 09 094
F6		2,5 m			€ 36,80	€ 43,80	219 09 064
F2		2,5 m			€ 36,80	€ 43,80	219 09 024
F7		2,5 m			€ 101,00	€ 120,20	219 09 074
F0		2,5 m	G		€ 25,30	€ 30,10	219 09 104
F3		2,5 m	G		€ 30,50	€ 36,30	219 09 134
F4		2,5 m	G</				

Artikel	Farben	Länge	Version	SB	Preis/Stück	unit price	Bestell-Nr.
article	colour	length	version	SB	exkl. MwSt.	inkl. MwSt.	order no.
	F5	2,5 m	G		€ 35,50	€ 42,25	219 35 154
	F9	2,5 m	G		€ 32,00	€ 38,10	219 35 194
	F6	2,5 m	G		€ 35,50	€ 42,25	219 35 164
	F2	2,5 m	G		€ 35,50	€ 42,25	219 35 124
336 G	F0	2,5 m	G		€ 27,50	€ 32,75	219 36 104
	F3	2,5 m	G		€ 33,30	€ 39,65	219 36 134
	F4	2,5 m	G		€ 33,30	€ 39,65	219 36 144
	F5	2,5 m	G		€ 37,00	€ 44,05	219 36 154
	F9	2,5 m	G		€ 33,30	€ 39,65	219 36 194
	F6	2,5 m	G		€ 37,00	€ 44,05	219 36 164
	F2	2,5 m	G		€ 37,00	€ 44,05	219 36 124

Bewegungsfugenprofile (Motion Star)
Expansion Joint Profiles (Motion Star)

316	F4	2,7 m	V		€ 82,40	€ 98,05	317 316 034 5
	F2	2,7 m	V		€ 85,30	€ 101,50	317 316 032 5
	F4	2,7 m	SK		€ 93,20	€ 110,90	215 316 034 5
	F2	2,7 m	SK		€ 96,10	€ 114,35	215 316 032 5
317	F4	2,7 m	V		€ 85,10	€ 101,25	317 317 034 5
	F9	2,7 m	V		€ 85,10	€ 101,25	317 317 039 5
	F6	2,7 m	V		€ 88,00	€ 104,70	317 317 036 5
	F2	2,7 m	V		€ 88,00	€ 104,70	317 317 032 5
	F4	2,7 m	G		€ 89,60	€ 106,60	219 317 034 5
	F9	2,7 m	G		€ 89,60	€ 106,60	219 317 039 5
	F6	2,7 m	G		€ 93,20	€ 110,90	219 317 036 5
	F2	2,7 m	G		€ 93,20	€ 110,90	219 317 032 5
	F4	2,7 m	SK		€ 95,90	€ 114,10	215 317 034 5
	F2	2,7 m	SK		€ 98,80	€ 117,55	215 317 032 5
318	F4	2,7 m	G		€ 100,40	€ 119,50	219 318 034 5
	F9	2,7 m	G		€ 100,40	€ 119,50	219 318 039 5
	F6	2,7 m	G		€ 104,20	€ 124,00	219 318 036 5
	F2	2,7 m	G		€ 104,20	€ 124,00	219 318 032 5
	F4	2,7 m	SK		€ 106,70	€ 126,95	215 318 034 5
	F2	2,7 m	SK		€ 109,60	€ 130,40	215 318 032 5
319 G	F4	2,7 m	G		€ 106,40	€ 126,60	219 319 034 5
	F9	2,7 m	G		€ 106,40	€ 126,60	219 319 039 5
	F6	2,7 m	G		€ 110,40	€ 131,40	219 319 036 5
	F2	2,7 m	G		€ 110,40	€ 131,40	219 319 032 5
323 G	F4	2,7 m	G		€ 111,30	€ 132,45	219 323 034 5
	F2	2,7 m	G		€ 115,90	€ 137,90	219 323 032 5
324 G	F4	2,7 m	G		€ 111,30	€ 132,45	219 324 034 5
	F2	2,7 m	G		€ 115,90	€ 137,90	219 324 032 5

Biegbare Einfass- und Abschlußprofile
Bendable Border Profiles

356 EB	F4	2,5 m	EB		€ 24,50	€ 29,15	219 56 044
357 EB	F4	2,5 m	EB		€ 25,80	€ 30,70	219 57 044
359 EB	F4	2,5 m	EB		€ 27,00	€ 32,15	219 59 044
361/3 EB	F4	2,5 m	EB		€ 29,00	€ 34,50	219 61 044
371 EB	F4	2,7 m	EB		€ 32,70	€ 38,90	219 71 045
363 EB	F4	2,7 m	EB		€ 43,50	€ 51,75	219 363 004 5
365 EB	F4	3,0 m	EB		€ 48,00	€ 57,10	219 65 048
366 EB	F4	2,7 m	EB		€ 45,90	€ 54,60	219 66 045
368 EB	F4	2,7 m	EB		€ 47,30	€ 56,30	219 368 004 5
345 EB	F4	3,0 m	EB		€ 43,80	€ 52,10	219 345 004 8
297 EB	F4	2,7 m	EB		€ 47,80	€ 56,90	219 297 004 5
801 EB	F4	2,5 m	EB		€ 32,80	€ 39,05	219 801 004 4
802 EB	F4	2,5 m	EB		€ 33,50	€ 39,85	219 802 004 4
803 EB	F4	2,5 m	EB		€ 34,30	€ 40,80	219 803 004 4
804 EB	F4	2,5 m	EB		€ 32,80	€ 39,05	219 804 004 4
806 EB	F4	2,5 m	EB		€ 33,30	€ 39,65	219 96 044
805 EB	F4	2,5 m	EB		€ 33,80	€ 40,20	219 95 044
210 EB	F4	2,7 m	EB		€ 37,30	€ 44,40	219 10 045
212 EB	F4	2,7 m	EB		€ 37,80	€ 45,00	219 12 045
213 EB	F4	2,7 m	EB		€ 39,40	€ 46,90	219 13 045

Biegbare Treppenkantenprofile
Bendable Star Nosings

809 EB	F4	5,0 m	EB		€ 84,00	€ 99,95	219 809 004 7
		2,5 m	EB		€ 42,30	€ 50,35	219 809 004 4
	F2	5,0 m	EB		€ 89,50	€ 106,50	219 809 002 7
		2,5 m	EB		€ 45,00	€ 53,55	219 809 002 4
807 EB	F4	5,0 m	EB		€ 88,00	€ 104,70	219 807 004 7
		2,5 m	EB		€ 44,30	€ 52,70	219 807 004 4
	F2	5,0 m	EB		€ 94,50	€ 112,45	219 807 002 7
		2,5 m	EB		€ 47,50	€ 56,55	219 807 002 4

Artikel	Farben	Länge	Version	SB	Preis/Stück	unit price	Bestell-Nr.
article	colour	length	version	SB	exkl. MwSt.	inkl. MwSt.	order no.
808 EB	F4	5,0 m	EB		€ 90,50	€ 107,70	219 808 004 7
		2,5 m	EB		€ 45,50	€ 54,15	219 808 004 4
	F2	5,0 m	EB		€ 97,00	€ 115,45	219 808 002 7
		2,5 m	EB		€ 48,80	€ 58,05	219 808 002 4
810 EB	F4	5,0 m	EB		€ 91,50	€ 108,90	219 810 004 7
		2,5 m	EB		€ 46,00	€ 54,75	219 810 004 4
	F2	5,0 m	EB		€ 97,00	€ 115,45	219 810 002 7
		2,5 m	EB		€ 48,80	€ 58,05	219 810 002 4
811 EB	F4	5,0 m	EB		€ 97,00	€ 115,45	219 811 004 7
		2,5 m	EB		€ 48,80	€ 58,05	219 811 004 4
	F2	5,0 m	EB		€ 102,50	€ 122,00	219 811 002 7
		2,5 m	EB		€ 51,50	€ 61,30	219 811 002 4
812 EB	F4	5,0 m	EB		€ 101,50	€ 120,80	219 812 004 7
		2,5 m	EB		€ 51,00	€ 60,70	219 812 004 4
	F2	5,0 m	EB		€ 107,00	€ 127,35	219 812 002 7
		2,5 m	EB		€ 53,80	€ 64,00	219 812 002 4
813 EB	F4	5,0 m	EB		€ 104,50	€ 124,35	219 813 004 7
		2,5 m	EB		€ 52,50	€ 62,50	219 813 004 4
	F2	5,0 m	EB		€ 111,00	€ 132,10	219 813 002 7
		2,5 m	EB		€ 55,80	€ 66,40	219 813 002 4
852 EB	F4	5,0 m	EB		€ 128,00	€ 152,30	219 852 004 7
		2,5 m	EB		€ 64,30	€ 76,50	219 852 004 4
	F2	5,0 m	EB		€ 133,50	€ 158,85	219 852 002 7
		2,5 m	EB		€ 67,00	€ 79,75	219 852 002 4
859 EB	F4	5,0 m	EB		€ 101,00	€ 120,20	219 859 004 7
		2,5 m	EB		€ 50,80	€ 60,45	219 859 004 4
	F2	5,0 m	EB		€ 110,00	€ 130,90	219 859 002 7
		2,5 m	EB		€ 55,30	€ 65,80	219 859 002 4
860 EB	F4	5,0 m	EB		€ 102,50	€ 122,00	219 860 004 7
		2,5 m	EB		€ 51,50	€ 61,30	219 860 004 4
	F2	5,0 m	EB		€ 110,50	€ 131,50	219 860 002 7
		2,5 m	EB		€ 55,50	€ 66,05	219 860 002 4
	F7	5,0 m	EB		€ 300,00	€ 357,00	219 860 007 7
		2,5 m	EB		€ 150,30	€ 178,85	219 860 007 4
861 EB	F4	5,0 m	EB		€ 104,50	€ 124,35	219 861 004 7
		2,5 m	EB		€ 52,50	€ 62,50	219 861 004 4
	F2	5,0 m	EB		€ 112,00	€ 133,30	219 861 002 7
		2,5 m	EB		€ 56,30	€ 67,00	219 861 002 4
863 EB	F4	5,0 m	EB		€ 106,00	€ 126,15	219 863 004 7
		2,5 m	EB		€ 53,30	€ 63,45	219 863 004 4
	F2	5,0 m	EB		€ 113,00	€ 134,45	219 863 002 7
		2,5 m	EB		€ 56,80	€ 67,60	219 863 002 4
864 EB	F4	5,0 m	EB		€ 107,50	€ 127,95	219 864 004 7
		2,5 m	EB		€ 54,00	€ 64,25	219 864 004 4
	F2	5,0 m	EB		€ 114,00	€ 135,65	219 864 002 7
		2,5 m	EB		€ 57,30	€ 68,20	219 864 002 4
862 EB	F4	5,0 m	EB		€ 123,50	€ 146,95	219 862 004 7
		2,5 m	EB		€ 62,00	€ 73,80	219 862 004 4
	F2	5,0 m	EB		€ 135,00	€ 160,65	219 862 002 7
		2,5 m	EB		€ 67,80	€ 80,70	219 862 002 4
870 EB	F4	5,0 m	EB		€ 111,00	€ 132,10	219 870 004 7
		2,5 m	EB		€ 55,80	€ 66,40	219 870 004 4
	F2	5,0 m	EB		€ 119,50	€ 142,20	219 870 002 7
		2,5 m	EB		€ 60,00	€ 71,40	219 870 002 4
871 EB	F4	5,0 m	EB		€ 112,00	€ 133,30	219 871 004 7
		2,5 m	EB		€ 56,30	€ 67,00	219 871 004 4
	F2	5,0 m	EB		€ 119,50	€ 142,20	219 871 002 7
		2,5 m	EB		€ 60,00	€ 71,40	219 871 002 4
872 EB	F4	5,0 m	EB		€ 115,00	€ 136,85	219 872 004 7
		2,5 m	EB		€ 57,80	€ 68,80	219 872 004 4
	F2	5,0 m	EB		€ 123,00	€ 146,35	219 872 002 7
		2,5 m	EB		€ 61,80	€ 73,55	219 872 002 4
873 EB	F4	5,0 m	EB		€ 119,00	€ 141,60	219 873 004 7
		2,5 m	EB		€ 59,80	€ 71,15	219 873 004 4
	F2	5,0 m	EB		€ 125,50	€ 149,35	219 873 002 7
		2,5 m	EB		€ 63,00	€ 74,95	219 873 002 4
874 EB	F4	5,0 m	EB		€ 126,00	€ 149,95	219 874 004 7
		2,5 m	EB		€ 63,30	€ 75,35	219 874 004 4
	F2	5,0 m	EB		€ 136,50	€ 162,45	219 874 002 7
		2,5 m	EB		€ 68,50	€ 81,50	219 874 002 4

Biegbare T-Profile
Bendable T Profiles

290	F3	2,7 m			€ 18,60	€ 22,15	219 90 035
	F4	2,7 m			€ 18,60	€ 22,15	219 90 045
	F5	2,7 m			€ 20,80	€ 24,75	219 90 055
	F9	2,7 m			€ 18,60	€ 22,15	219 90 095
	F6	2,7 m			€ 20,80	€ 24,75	219 90 065
	F2G	2,7 m			€ 22,40	€ 26,65	219 90 025
	F7	2,7 m			€ 46,40	€ 55,20	219 90 075
	F8	2,5 m			€ 47,30	€ 56,30	219 290 408 4
	F8G	2,5 m			€ 51,60	€ 61,40	219 290 402 4

Artikel	Farben	Länge	Version	Preis/Stück	unit price	Bestell-Nr.
article	colour	length	version	exkl. MwSt. excl. VAT	inkl. MwSt. incl. VAT	order no.
H20		2,7 m		€ 30,00	€ 35,70	219 90 205
H22		2,7 m		€ 30,00	€ 35,70	219 90 225
H30		2,7 m		€ 30,00	€ 35,70	219 90 305
H31		2,7 m		€ 30,00	€ 35,70	219 90 315
H33		2,7 m		€ 30,00	€ 35,70	219 90 335
H40		2,7 m		€ 30,00	€ 35,70	219 90 405
H61		2,7 m		€ 30,00	€ 35,70	219 90 615
H62		2,7 m		€ 30,00	€ 35,70	219 90 625
H63		2,7 m		€ 30,00	€ 35,70	219 90 635
H64		2,7 m		€ 30,00	€ 35,70	219 90 645
H65		2,7 m		€ 30,00	€ 35,70	219 90 655
H80		2,7 m		€ 30,00	€ 35,70	219 90 805
H81		2,7 m		€ 30,00	€ 35,70	219 90 835
H95		2,7 m		€ 30,00	€ 35,70	219 90 955
291						
F3		2,7 m		€ 21,10	€ 25,10	219 91 035
F4		2,7 m		€ 21,10	€ 25,10	219 91 045
F5		2,7 m		€ 23,50	€ 27,95	219 91 055
F9		2,7 m		€ 21,10	€ 25,10	219 91 095
F6		2,7 m		€ 23,50	€ 27,95	219 91 065
F2G		2,7 m		€ 27,30	€ 32,50	219 91 025
H20		2,7 m		€ 32,90	€ 39,15	219 91 205
H22		2,7 m		€ 32,90	€ 39,15	219 91 225
H30		2,7 m		€ 32,90	€ 39,15	219 91 305
H31		2,7 m		€ 32,90	€ 39,15	219 91 315
H33		2,7 m		€ 32,90	€ 39,15	219 91 335
H40		2,7 m		€ 32,90	€ 39,15	219 91 405
H61		2,7 m		€ 32,90	€ 39,15	219 91 615
H62		2,7 m		€ 32,90	€ 39,15	219 91 625
H63		2,7 m		€ 32,90	€ 39,15	219 91 635
H64		2,7 m		€ 32,90	€ 39,15	219 91 645
H65		2,7 m		€ 32,90	€ 39,15	219 91 655
H80		2,7 m		€ 32,90	€ 39,15	219 91 805
H81		2,7 m		€ 32,90	€ 39,15	219 91 835
H95		2,7 m		€ 32,90	€ 39,15	219 91 955
295						
F3		2,7 m		€ 22,40	€ 26,65	219 295 003 5
F4		2,7 m		€ 22,40	€ 26,65	219 295 004 5
F5		2,7 m		€ 24,60	€ 29,25	219 295 005 5
F9		2,7 m		€ 22,40	€ 26,65	219 295 009 5
F6		2,7 m		€ 24,60	€ 29,25	219 295 006 5
F2G		2,7 m		€ 28,90	€ 34,40	219 295 002 5
293						
F3		2,7 m		€ 23,80	€ 28,30	219 93 035
F4		2,7 m		€ 23,80	€ 28,30	219 93 045
F5		2,7 m		€ 26,50	€ 31,55	219 93 055
F9		2,7 m		€ 23,80	€ 28,30	219 93 095
F6		2,7 m		€ 26,50	€ 31,55	219 93 065
F2G		2,7 m		€ 30,50	€ 36,30	219 93 025
H20		2,7 m		€ 36,20	€ 43,10	219 93 205
H22		2,7 m		€ 36,20	€ 43,10	219 93 225
H30		2,7 m		€ 36,20	€ 43,10	219 93 305
H31		2,7 m		€ 36,20	€ 43,10	219 93 315
H33		2,7 m		€ 36,20	€ 43,10	219 93 335
H40		2,7 m		€ 36,20	€ 43,10	219 93 405
H61		2,7 m		€ 36,20	€ 43,10	219 93 615
H62		2,7 m		€ 36,20	€ 43,10	219 93 625
H63		2,7 m		€ 36,20	€ 43,10	219 93 635
H64		2,7 m		€ 36,20	€ 43,10	219 93 645
H65		2,7 m		€ 36,20	€ 43,10	219 93 655
H80		2,7 m		€ 36,20	€ 43,10	219 93 805
H81		2,7 m		€ 36,20	€ 43,10	219 93 835
H95		2,7 m		€ 36,20	€ 43,10	219 93 955

Lamellendübel/rib dowels			
14 St. pro Beutel/pieces per bag	€ 11,80	€ 14,05	106 61 052
Biegemaschine/bending machine	Preis auf Anfrage/Price upon request		119 99 018
Biegemaschine für biegbare TK-Profile bending machine for bendable TK-profiles	Preis auf Anfrage/Price upon request		119 99 020
Umbauset zur Version für biegbare TK-Profile Conversion set for bendable TK-profiles	Preis auf Anfrage/Price upon request		119 99 019



Wand-, Tapetenprofile und Eckschutzwinkel
Wallpaper Profiles and Corner Guards

Artikel	Farben	Länge	Version	Preis/Stück	unit price	Bestell-Nr.
article	colour	length	version	exkl. MwSt. excl. VAT	inkl. MwSt. incl. VAT	order no.
271	F0	5,0 m	U	€ 37,50	€ 44,65	227 271 000 7
		2,5 m	U	€ 19,00	€ 22,60	227 271 000 4
	F4	5,0 m	U	€ 44,50	€ 52,95	227 271 004 7
		2,5 m	U	€ 22,50	€ 26,80	227 271 004 4
	F2G	5,0 m	U	€ 57,00	€ 67,85	227 271 002 7
		2,5 m	U	€ 28,80	€ 34,25	227 271 002 4
	F15 RAL9016	2,5 m	U	€ 33,50	€ 39,85	227 271 715 4
	F0	5,0 m	SK	€ 58,50	€ 69,60	227 271 050 7
		2,5 m	SK	€ 29,50	€ 35,10	227 271 050 4
	F4	5,0 m	SK	€ 66,50	€ 79,15	227 271 054 7
		2,5 m	SK	€ 33,50	€ 39,85	227 271 054 4
	F2G	5,0 m	SK	€ 79,00	€ 94,00	227 271 052 7
		2,5 m	SK	€ 39,80	€ 47,35	227 271 052 4
	F15 RAL9016	2,5 m	SK	€ 44,30	€ 52,70	227 271 755 4
273	F0	5,0 m	U	€ 51,00	€ 60,70	227 273 000 7
		2,5 m	U	€ 25,80	€ 30,70	227 273 000 4
	F4	5,0 m	U	€ 62,50	€ 74,40	227 273 004 7
		2,5 m	U	€ 31,50	€ 37,50	227 273 004 4
	F2G	5,0 m	U	€ 80,00	€ 95,20	227 273 002 7
		2,5 m	U	€ 40,30	€ 47,95	227 273 002 4
	F15 RAL9016	2,5 m	U	€ 43,00	€ 51,15	227 273 715 4
	F0	5,0 m	SK	€ 72,50	€ 86,30	227 273 050 7
		2,5 m	SK	€ 36,50	€ 43,45	227 273 050 4
	F4	5,0 m	SK	€ 84,50	€ 100,55	227 273 054 7
		2,5 m	SK	€ 42,50	€ 50,60	227 273 054 4
	F2G	5,0 m	SK	€ 102,50	€ 122,00	227 273 052 7
		2,5 m	SK	€ 51,50	€ 61,30	227 273 052 4
	F15 RAL9016	2,5 m	SK	€ 54,30	€ 64,60	227 273 755 4
275	F0	5,0 m	U	€ 97,00	€ 115,45	227 275 000 7
		2,5 m	U	€ 48,80	€ 58,05	227 275 000 4
	F4	5,0 m	U	€ 115,00	€ 136,85	227 275 004 7
		2,5 m	U	€ 57,80	€ 68,80	227 275 004 4
	F2G	5,0 m	U	€ 147,00	€ 174,95	227 275 002 7
		2,5 m	U	€ 73,80	€ 87,80	227 275 002 4
	F0	5,0 m	SK	€ 122,50	€ 145,80	227 275 050 7
		2,5 m	SK	€ 61,50	€ 73,20	227 275 050 4
	F4	5,0 m	SK	€ 141,00	€ 167,80	227 275 054 7
		2,5 m	SK	€ 70,80	€ 84,25	227 275 054 4
	F2G	5,0 m	SK	€ 172,50	€ 205,30	227 275 052 7
		2,5 m	SK	€ 86,50	€ 102,95	227 275 052 4
283	F0	5,0 m	U	€ 51,00	€ 60,70	227 283 000 7
		2,5 m	U	€ 25,80	€ 30,70	227 283 000 4
	F4	5,0 m	U	€ 62,50	€ 74,40	227 283 004 7
		2,5 m	U	€ 31,50	€ 37,50	227 283 004 4
	F2G	5,0 m	U	€ 80,00	€ 95,20	227 283 002 7
		2,5 m	U	€ 40,30	€ 47,95	227 283 002 4
	F0	5,0 m	SK	€ 72,50	€ 86,30	227 283 050 7
		2,5 m	SK	€ 36,50	€ 43,45	227 283 050 4
	F4	5,0 m	SK	€ 84,50	€ 100,55	227 283 054 7
		2,5 m	SK	€ 42,50	€ 50,60	227 283 054 4
	F2G	5,0 m	SK	€ 102,50	€ 122,00	227 283 052 7
		2,5 m	SK	€ 51,50	€ 61,30	227 283 052 4
272 U	F8G	2,5 m	U	€ 73,30	€ 87,25	227 272 402 4
274 U	F8G	2,5 m	U	€ 97,50	€ 116,05	227 274 402 4
276 U	F8G	2,5 m	U	€ 139,00	€ 165,40	227 276 402 4
542 U	F8G	2,5 m	U	€ 69,50	€ 82,70	211 542 402 4
543 U	F8G	2,5 m	U	€ 94,00	€ 111,85	211 543 402 4
142 U	F8G	2,5 m	U	€ 50,30	€ 59,85	211 142 402 4
	F8G	1,5 m	U	€ 35,30	€ 42,00	211 142 402 9

Artikel	Farben	Länge	Version	Preis/Stück	unit price	Bestell-Nr.
article	colour	length	version	exkl. MwSt.	inkl. MwSt.	order no.
	F8G	1,25 m	U	€ 29,40	€ 35,00	211 142 402 2
142 U-K	F8G	1,5 m	U	€ 45,70	€ 54,40	211 142 482 9
	F8G	1,25 m	U	€ 38,10	€ 45,35	211 142 482 2
142 SK	F8G	2,5 m	SK	€ 60,80	€ 72,35	215 142 402 4
	F8G	1,5 m	SK	€ 41,50	€ 49,40	215 142 402 9
	F8G	1,25 m	SK	€ 34,60	€ 41,15	215 142 402 2
142 SK-K	F8G	1,5 m	SK	€ 51,90	€ 61,75	215 142 492 9
	F8G	1,25 m	SK	€ 43,30	€ 51,55	215 142 492 2
143 U	F8G	2,5 m	U	€ 61,80	€ 73,55	211 143 402 4
	F8G	1,5 m	U	€ 42,20	€ 50,20	211 143 402 9
	F8G	1,25 m	U	€ 35,20	€ 41,90	211 143 402 2
143 U-K	F8G	1,5 m	U	€ 52,60	€ 62,60	211 143 482 9
	F8G	1,25 m	U	€ 43,90	€ 52,25	211 143 482 2
143 SK	F8G	2,5 m	SK	€ 72,30	€ 86,05	215 143 402 4
	F8G	1,5 m	SK	€ 48,50	€ 57,70	215 143 402 9
	F8G	1,25 m	SK	€ 40,40	€ 48,10	215 143 402 2
143 SK-K	F8G	1,5 m	SK	€ 58,90	€ 70,10	215 143 492 9
	F8G	1,25 m	SK	€ 49,10	€ 58,45	215 143 492 2
172 U	F8G	2,5 m	U	€ 56,50	€ 67,25	227 172 402 4
	F8G	1,5 m	U	€ 41,10	€ 48,90	227 172 402 9
	F8G	1,25 m	U	€ 34,30	€ 40,80	227 172 402 2
172 U-K	F8G	1,5 m	U	€ 51,50	€ 61,30	227 172 482 9
	F8G	1,25 m	U	€ 42,90	€ 51,05	227 172 482 2
172 SK	F8G	2,5 m	SK	€ 67,00	€ 79,75	227 172 452 4
	F8G	1,5 m	SK	€ 47,30	€ 56,30	227 172 452 9
	F8G	1,25 m	SK	€ 39,40	€ 46,90	227 172 452 2
172 SK-K	F8G	1,5 m	SK	€ 57,70	€ 68,65	227 172 492 9
	F8G	1,25 m	SK	€ 48,10	€ 57,25	227 172 492 2
174 U	F8G	2,5 m	U	€ 68,30	€ 81,30	227 174 402 4
	F8G	1,5 m	U	€ 48,10	€ 57,25	227 174 402 9
	F8G	1,25 m	U	€ 40,10	€ 47,70	227 174 402 2
174 U-K	F8G	1,5 m	U	€ 58,40	€ 69,50	227 174 482 9
	F8G	1,25 m	U	€ 48,70	€ 57,95	227 174 482 2
174 SK	F8G	2,5 m	SK	€ 78,80	€ 93,75	227 174 452 4
	F8G	1,5 m	SK	€ 54,30	€ 64,60	227 174 452 9
	F8G	1,25 m	SK	€ 45,30	€ 53,90	227 174 452 2
174 SK-K	F8G	1,5 m	SK	€ 64,70	€ 77,00	227 174 492 9
	F8G	1,25 m	SK	€ 53,90	€ 64,15	227 174 492 2
299	F4	2,5 m	U	€ 19,00	€ 22,60	219 99 244
	F5	2,5 m	U	€ 20,80	€ 24,75	219 99 254
	F2	2,5 m	U	€ 20,80	€ 24,75	219 99 224
	F15 RAL9016	2,5 m	U	€ 29,00	€ 34,50	219 299 725 4
	F16 RAL9005	2,5 m	U	€ 29,00	€ 34,50	219 299 721 4
	F4	2,5 m	G	€ 21,00	€ 25,00	219 99 144
	F5	2,5 m	G	€ 23,30	€ 27,75	219 99 154
	F2	2,5 m	G	€ 23,30	€ 27,75	219 99 124
	F15 RAL9016	2,5 m	G	€ 31,00	€ 36,90	219 299 715 4
	F16 RAL9005	2,5 m	G	€ 31,00	€ 36,90	219 299 711 4
355	F4	2,5 m	V	€ 17,50	€ 20,85	217 55 044
	F5	2,5 m	V	€ 20,30	€ 24,15	217 55 054
	F2	2,5 m	V	€ 20,30	€ 24,15	217 55 024
	F15 RAL9016	2,5 m	V	€ 27,80	€ 33,10	217 355 715 4
	F16 RAL9005	2,5 m	V	€ 27,80	€ 33,10	217 355 701 4
365	F4	3,0 m	V	€ 33,00	€ 39,25	217 65 048
	F5	3,0 m	V	€ 36,30	€ 43,20	217 65 058
	F2	3,0 m	V	€ 36,30	€ 43,20	217 65 028
	F15 RAL9016	3,0 m	V	€ 45,30	€ 53,90	217 365 715 8
	F16 RAL9005	3,0 m	V	€ 45,30	€ 53,90	217 365 701 8

Wand- und Tapetenprofile

Wallpaper Profiles

150	F4	2,7 m	U	€ 23,20	€ 27,60	227 150 004 5
	F5	2,7 m	U	€ 24,30	€ 28,90	227 150 005 5
	F2G	2,7 m	U	€ 26,70	€ 31,75	227 150 002 5
	F15 RAL9016	2,7 m	U	€ 34,60	€ 41,15	227 150 715 5
	F16 RAL9005	2,7 m	U	€ 34,60	€ 41,15	227 150 701 5
	F4	2,7 m	G	€ 30,00	€ 35,70	219 150 014 5
	F5	2,7 m	G	€ 31,10	€ 37,00	219 150 015 5
	F2G	2,7 m	G	€ 33,80	€ 40,20	219 150 012 5
	F15 RAL9016	2,7 m	G	€ 41,60	€ 49,50	219 150 715 5
	F16 RAL9005	2,7 m	G	€ 41,60	€ 49,50	219 150 711 5
155	F4	2,7 m	U	€ 23,00	€ 27,35	227 155 004 5
	F5	2,7 m	U	€ 24,00	€ 28,55	227 155 005 5
	F2G	2,7 m	U	€ 26,50	€ 31,55	227 155 002 5
	F15 RAL9016	2,7 m	U	€ 34,30	€ 40,80	227 155 715 5
	F16 RAL9005	2,7 m	U	€ 34,30	€ 40,80	227 155 701 5
	F4	2,7 m	G	€ 29,70	€ 35,35	219 155 014 5
	F5	2,7 m	G	€ 30,80	€ 36,65	219 155 015 5
	F2G	2,7 m	G	€ 33,50	€ 39,85	219 155 012 5
	F15 RAL9016	2,7 m	G	€ 41,30	€ 49,15	219 155 715 5
	F16 RAL9005	2,7 m	G	€ 41,30	€ 49,15	219 155 711 5

Artikel	Farben	Länge	Version	Preis/Stück	unit price	Bestell-Nr.
article	colour	length	version	exkl. MwSt.	inkl. MwSt.	order no.
160	F4	2,7 m	U	€ 22,70	€ 27,00	227 160 004 5
	F5	2,7 m	U	€ 23,80	€ 28,30	227 160 005 5
	F2G	2,7 m	U	€ 26,20	€ 31,20	227 160 002 5
	F15 RAL9016	2,7 m	U	€ 34,00	€ 40,45	227 160 715 5
	F16 RAL9005	2,7 m	U	€ 34,00	€ 40,45	227 160 701 5
	F4	2,7 m	G	€ 29,40	€ 35,00	219 160 014 5
	F5	2,7 m	G	€ 30,50	€ 36,30	219 160 015 5
	F2G	2,7 m	G	€ 32,90	€ 39,15	219 160 012 5
	F15 RAL9016	2,7 m	G	€ 41,00	€ 48,80	219 160 715 5
	F16 RAL9005	2,7 m	G	€ 41,00	€ 48,80	219 160 711 5
170	F4	2,7 m	U	€ 22,40	€ 26,65	227 170 004 5
	F5	2,7 m	U	€ 23,50	€ 27,95	227 170 005 5
	F2G	2,7 m	U	€ 25,70	€ 30,60	227 170 002 5
	F15 RAL9016	2,7 m	U	€ 33,80	€ 40,20	227 170 715 5
	F16 RAL9005	2,7 m	U	€ 33,80	€ 40,20	227 170 701 5
	F4	2,7 m	G	€ 29,20	€ 34,75	219 170 014 5
	F5	2,7 m	G	€ 30,20	€ 35,95	219 170 015 5
	F2G	2,7 m	G	€ 31,30	€ 37,25	219 170 012 5
	F15 RAL9016	2,7 m	G	€ 40,80	€ 48,55	219 170 715 5
	F16 RAL9005	2,7 m	G	€ 40,80	€ 48,55	219 170 711 5



Deco Base-Board – Aluminium-Sockelleisten
Aluminium Baseboards

Artikel	Farben	Länge	Version	SB	Preis/Stück	unit price	Bestell-Nr.
article	colour	length	version	SB	exkl. MwSt.	inkl. MwSt.	order no.
938	F4	2,5 m	•		€ 66,50	€ 79,15	320 938 004 4
	F2G	2,5 m	•		€ 82,30	€ 97,95	320 938 002 4
938 D	F4	2,5 m	•		€ 90,50	€ 107,70	320 938 094 4
	F2G	2,5 m	•		€ 106,50	€ 126,75	320 938 092 4
935	F4	2,5 m	•		€ 55,80	€ 66,40	320 35 044
	F2G	2,5 m	•		€ 66,50	€ 79,15	320 35 024
936	F4	2,5 m	•		€ 59,30	€ 70,55	320 36 044
	F2G	2,5 m	•		€ 75,00	€ 89,25	320 36 024
950	F4	2,5 m	•		€ 82,50	€ 98,20	320 50 044
	F2G	2,5 m	•		€ 99,50	€ 118,40	320 50 024
950 D	F4	2,5 m	•		€ 107,00	€ 127,35	320 50 944
	F2G	2,5 m	•		€ 123,50	€ 146,95	320 50 924
934	F4	2,5 m	•		€ 85,50	€ 101,75	320 34 044
	F2G	2,5 m	•		€ 102,80	€ 122,35	320 34 024
934 D	F4	2,5 m	•		€ 109,30	€ 130,05	320 34 944
	F2G	2,5 m	•		€ 126,80	€ 150,90	320 34 924
945 U	F4	2,5 m	U		€ 45,30	€ 53,90	220 45 044
	F2G	2,5 m	U		€ 56,30	€ 67,00	220 45 024
927	F4	2,5 m	U		€ 23,50	€ 27,95	320 927 004 4
	F2	2,5 m	U		€ 28,30	€ 33,70	320 927 002 4
910	F4	2,5 m	U		€ 31,00	€ 36,90	220 10 044
	F2G	2,5 m	U		€ 36,50	€ 43,45	220 10 024
	F4	2,5 m	SK		€ 41,00	€ 48,80	220 10 544
	F2G	2,5 m	SK		€ 45,80	€ 54,50	220 10 524
911	F4	2,5 m	U		€ 34,30	€ 40,80	220 11 044
	F2G	2,5 m	U		€ 41,00	€ 48,80	220 11 024
	F4	2,5 m	SK		€ 44,00	€ 52,35	220 11 544
	F2G	2,5 m	SK		€ 50,80	€ 60,45	220 11 524
912	F4	2,5 m	U		€ 39,00	€ 46,40	220 12 044
	F2G	2,5 m	U		€ 45,80	€ 54,50	220 12 024
	F4	2,5 m	SK		€ 48,80	€ 58,05	220 12 544
	F2G	2,5 m	SK		€ 55,80	€ 66,40	220 12 524
913	F4	2,5 m	U		€ 42,50	€ 50,60	220 913 004 4
	F2G	2,5 m	U		€ 51,00	€ 60,70	220 913 002 4
	F4	2,5 m	SK		€ 52,80	€ 62,85	220 913 054 4
	F2G	2,5 m	SK		€ 61,30	€ 72,95	220 913 052 4
901	F4	5,0 m	•		€ 65,00	€ 77,35	320 01 047
	F2G	5,0 m	•		€ 82,50	€ 98,25	320 01 044
	F4	5,0 m	•		€ 77,50	€ 92,25	320 01 027
	F2G	5,0 m	•		€ 95,80	€ 114,65	320 01 024
916 U	F8G	2,5 m			€ 85,80	€ 102,10	220 916 402 4
917 U	F8G	2,5 m			€ 103,30	€ 122,95	220 917 402 4
917 AE	F8G				€ 108,60	€ 129,25	120 917 432 9
917 IE	F8G				€ 108,60	€ 129,25	120 917 442 9

Artikel	Farben	Länge	Version	SB	Preis/Stück	unit price	Bestell-Nr.
article	colour	length	version	SB	exkl. MwSt.	inkl. MwSt.	order no.
Aluminium End- und Eckstücke für Typ 935+936							
Aluminium end caps and corners for type 935+936							
Endstück links/end cap left	F4	•	€ 16,80	€ 20,00	020 35 149		
	F2G	•	€ 18,90	€ 22,50	020 35 129		
Endstück rechts / end cap right	F4	•	€ 16,80	€ 20,00	020 35 249		
	F2G	•	€ 18,90	€ 22,50	020 35 229		
Außenecke / external corner	F4	•	€ 21,90	€ 26,05	020 35 349		
	F2G	•	€ 23,80	€ 28,30	020 35 329		
Innenecke/internal corner	F4	•	€ 31,35	€ 37,30	020 35 449		
	F2G	•	€ 33,45	€ 39,80	020 35 429		
Verbinder/connecter	F4	•	€ 25,00	€ 29,75	020 35 549		
	F2G	•	€ 27,55	€ 32,80	020 35 529		
135° Außenecke/ext. corner	F4	•	€ 73,65	€ 87,65	020 35 649		
	F2G	•	€ 76,95	€ 91,55	020 35 629		
135° Innenecke/inter. corner	F4	•	€ 73,65	€ 87,65	020 35 749		
	F2G	•	€ 76,95	€ 91,55	020 35 729		

Aluminium End- und Eckstücke für Typ 938+938 D							
Aluminium end caps and corners for type 938+938 D							
Endstück links ohne Dichtlippe/end cap left without sealing lip	F4	•	€ 20,70	€ 24,65	020 938 014 9		
	F2G	•	€ 22,30	€ 26,55	020 938 012 9		
Endstück rechts ohne Dichtlippe / end cap right without sealing lip	F4	•	€ 20,70	€ 24,65	020 938 024 9		
	F2G	•	€ 22,30	€ 26,55	020 938 022 9		
Endstück links mit Dichtlippe / end cap left with sealing lip	F4	•	€ 20,70	€ 24,65	020 938 084 9		
	F2G	•	€ 22,30	€ 26,55	020 938 082 9		
Endstück rechts mit Dichtlippe / end cap right with sealing lip	F4	•	€ 20,70	€ 24,65	020 938 094 9		
	F2G	•	€ 22,30	€ 26,55	020 938 092 9		
Außenecke / external corner	F4	•	€ 32,65	€ 38,85	020 938 034 9		
	F2G	•	€ 34,30	€ 40,80	020 938 032 9		
Innenecke / internal corner	F4	•	€ 37,65	€ 44,80	020 938 044 9		
	F2G	•	€ 39,30	€ 46,75	020 938 042 9		
Verbinder/connecter	F4	•	€ 30,55	€ 36,35	020 938 054 9		
	F2G	•	€ 32,25	€ 38,40	020 938 052 9		

Aluminium End- und Eckstücke für Typ 950 + 950 D							
Aluminium end caps and corners for type 950 + 950 D							
Endstück links ohne Dichtlippe / end cap left without sealing lip	F4	•	€ 22,65	€ 26,95	020 50 149		
	F2G	•	€ 24,75	€ 29,45	020 50 129		
Endstück rechts ohne Dichtlippe / end cap right without sealing lip	F4	•	€ 22,65	€ 26,95	020 50 249		
	F2G	•	€ 24,75	€ 29,45	020 50 229		
Endstück links mit Dichtlippe / end cap left with sealing lip	F4	•	€ 22,65	€ 26,95	020 50 849		
	F2G	•	€ 24,75	€ 29,45	020 50 829		
Endstück rechts mit Dichtlippe / end cap right with sealing lip	F4	•	€ 22,65	€ 26,95	020 50 949		
	F2G	•	€ 24,75	€ 29,45	020 50 929		
Außenecke / external corner	F4	•	€ 27,75	€ 33,00	020 50 349		
	F2G	•	€ 29,55	€ 35,15	020 50 329		
Innenecke / internal corner	F4	•	€ 37,30	€ 44,40	020 50 449		
	F2G	•	€ 39,30	€ 46,75	020 50 429		
Verbinder/connecter	F4	•	€ 31,00	€ 36,90	020 50 549		
	F2G	•	€ 33,45	€ 39,80	020 50 529		

Aluminium End- und Eckstücke für Typ 934 D							
Aluminium end caps and corners for type 934 D							
Endstück links / end cap left	F4	•	€ 26,05	€ 31,00	020 34 149		
	F2G	•	€ 28,75	€ 34,20	020 34 129		
Endstück rechts / end cap right	F4	•	€ 26,05	€ 31,00	020 34 249		
	F2G	•	€ 28,75	€ 34,20	020 34 229		
Außenecke / external corner	F4	•	€ 42,45	€ 50,50	020 34 349		
	F2G	•	€ 46,30	€ 55,10	020 34 329		
Innenecke / internal corner	F4	•	€ 50,80	€ 60,45	020 34 449		
	F2G	•	€ 54,00	€ 64,25	020 34 429		
Verbinder/connecter	F4	•	€ 30,45	€ 36,25	020 34 549		
	F2G	•	€ 33,15	€ 39,45	020 34 529		
135° Außenecke/ext. corner	F4	•	€ 96,15	€ 114,40	020 34 649		
	F2G	•	€ 99,85	€ 118,80	020 34 629		
135° Innenecke/inter. corner	F4	•	€ 96,15	€ 114,40	020 34 749		
	F2G	•	€ 99,85	€ 118,80	020 34 729		

Aluminium End- und Eckstücke für Typ 945 U							
Aluminium end caps and corners for type 945 U							
Endstück links / end cap left	F4	•	€ 19,20	€ 22,85	020 45 149		
	F2G	•	€ 21,40	€ 25,45	020 45 129		
Endstück rechts / end cap right	F4	•	€ 19,20	€ 22,85	020 45 249		
	F2G	•	€ 21,40	€ 25,45	020 45 229		
Außenecke / external corner	F4	•	€ 24,40	€ 29,05	020 45 349		
	F2G	•	€ 26,35	€ 31,35	020 45 329		
Innenecke / internal corner	F4	•	€ 33,90	€ 40,35	020 45 449		
	F2G	•	€ 35,70	€ 42,50	020 45 429		
Verbinder/connecter	F4	•	€ 27,45	€ 32,65	020 45 549		
	F2G	•	€ 30,10	€ 35,80	020 45 529		

Artikel	Farben	Länge	Version	SB	Preis/Stück	unit price	Bestell-Nr.
article	colour	length	version	SB	exkl. MwSt.	inkl. MwSt.	order no.
Kunststoff End- und Eckstücke für Typ 912 U, 912 SK							
Plastic end caps and corners for type 912 U, 912 SK							
Endstück links / end cap left	F4	•	€ 6,00	€ 7,15	020 12 149		
	F2	•	€ 6,00	€ 7,15	020 12 129		
Endstück rechts / end cap right	F4	•	€ 6,00	€ 7,15	020 12 249		
	F2	•	€ 6,00	€ 7,15	020 12 229		
Außenecke / external corner	F4	•	€ 7,20	€ 8,55	020 12 349		
	F2	•	€ 7,20	€ 8,55	020 12 329		
Innenecke / internal corner	F4	•	€ 7,20	€ 8,55	020 12 449		
	F2	•	€ 7,20	€ 8,55	020 12 429		
Verbinder/connecter	F4	•	€ 6,00	€ 7,15	020 12 549		
	F2	•	€ 6,00	€ 7,15	020 12 529		

Kunststoff End- und Eckstücke für Typ 913 U, 913 SK							
Plastic end caps and corners for type 913 U, 913 SK							
Endstück links / end cap left1	F4	•	€ 6,50	€ 7,75	020 913 014 9		
	F2	•	€ 6,50	€ 7,75	020 913 012 9		
Endstück rechts / end cap right	F4	•	€ 6,50	€ 7,75	020 913 024 9		
	F2	•	€ 6,50	€ 7,75	020 913 022 9		
Außenecke / external corner	F4	•	€ 7,65	€ 9,10	020 913 034 9		
	F2	•	€ 7,65	€ 9,10	020 913 032 9		
Innenecke / internal corner	F4	•	€ 7,65	€ 9,10	020 913 044 9		
	F2	•	€ 7,65	€ 9,10	020 913 042 9		
Verbinder/connecter	F4	•	€ 6,50	€ 7,75	020 913 054 9		
	F2	•	€ 6,50	€ 7,75	020 913 052 9		

Wandhalter, einzeln / wall holder, available individually			
für Typ/ for types			
938, 935, 936 + 934	€ 1,50	€ 1,80	120 30 999
für Typ/for types 934 D + 938 D	€ 1,70	€ 2,00	120 34 999
Abstandhalter, einzeln / spacing piece, available individually			
für Typ 910, 911, 912 + 913			
for types 910, 911, 912 + 913	€ 0,80	€ 0,95	120 10 999
Klebeband zur Befestigung der Sockelleiste 945 U			
Adhesive tape for fixing skirting type 945 U			
	10,0 m	€ 50,25	€ 59,80 115 32 375
Dichtlippe	24,0 m	€ 141,60	€ 168,50 120 34 998



PPS®-Champion Star

PPS®-Lifter auf Seite 203 / PPS®-Lifter see page 203

Artikel	Farben	Länge	Version	SB	Preis/Stück	unit price	Bestell-Nr.
article	colour	length	version	SB	exkl. MwSt.	inkl. MwSt.	order no.
376	F4	3,0 m	•	€ 70,65	€ 84,05	090 76 048	
		2,7 m	•	€ 63,60	€ 75,70	090 76 045	
		1,0 m	•	€ 24,85	€ 29,55	090 76 041	
F5	3,0 m	•	€ 74,05	€ 88,10	090 76 058		
	2,7 m	•	€ 66,60	€ 79,25	090 76 055		
	1,0 m	•	€ 26,10	€ 31,05	090 76 051		
F9	3,0 m	•	€ 23,65	€ 28,15	090 76 050		
	3,0 m	•	€ 70,65	€ 84,05	090 76 098		
	2,7 m	•	€ 63,60	€ 75,70	090 76 095		
F6	1,0 m	•	€ 24,85	€ 29,55	090 76 091		
	3,0 m	•	€ 22,35	€ 26,60	090 76 090		
	2,7 m	•	€ 74,05	€ 88,10	090 76 068		
F2	1,0 m	•	€ 26,10	€ 31,05	090 76 061		
	0,9 m	•	€ 23,65	€ 28,15	090 76 060		
	3,0 m	•	€ 74,05	€ 88,10	090 76 028		
	2,7 m	•	€ 66,60	€ 79,25	090 76 025		
	1,0 m	•	€ 26,10	€ 31,05	090 76 021		
	0,9 m	•	€ 23,65	€ 28,15	090 76 020		

Artikel	Farben	Länge	Version	SB	Preis/Stück	unit price	Bestell-Nr.
article	colour	length	version	SB	exkl. MwSt.	inkl. MwSt.	order no.
377	F4	3,0 m	•	•	€ 60,30	€ 71,75	090 77 048
		2,7 m	•	•	€ 54,30	€ 64,60	090 77 045
		1,0 m	•	•	€ 21,55	€ 25,65	090 77 041
	F5	0,9 m	•	•	€ 19,45	€ 23,15	090 77 040
		3,0 m	•	•	€ 62,80	€ 74,75	090 77 058
		2,7 m	•	•	€ 56,50	€ 67,25	090 77 055
	F9	1,0 m	•	•	€ 22,20	€ 26,40	090 77 051
		0,9 m	•	•	€ 20,10	€ 23,90	090 77 050
		3,0 m	•	•	€ 60,30	€ 71,75	090 77 098
	F6	2,7 m	•	•	€ 54,30	€ 64,60	090 77 095
		1,0 m	•	•	€ 21,55	€ 25,65	090 77 091
		0,9 m	•	•	€ 19,45	€ 23,15	090 77 090
	F2	3,0 m	•	•	€ 62,80	€ 74,75	090 77 068
		2,7 m	•	•	€ 56,50	€ 67,25	090 77 065
		1,0 m	•	•	€ 22,20	€ 26,40	090 77 061
	F6	0,9 m	•	•	€ 20,10	€ 23,90	090 77 060
		3,0 m	•	•	€ 62,80	€ 74,75	090 77 028
		2,7 m	•	•	€ 56,50	€ 67,25	090 77 025
	F2	1,0 m	•	•	€ 22,20	€ 26,40	090 77 021
		0,9 m	•	•	€ 20,10	€ 23,90	090 77 020
		3,0 m	•	•	€ 63,70	€ 75,80	090 78 048
378	F4	2,7 m	•	•	€ 57,30	€ 68,20	090 78 045
		1,0 m	•	•	€ 22,60	€ 26,90	090 78 041
		0,9 m	•	•	€ 20,50	€ 24,40	090 78 040
	F5	3,0 m	•	•	€ 64,35	€ 76,60	090 78 058
		2,7 m	•	•	€ 59,35	€ 70,65	090 78 055
		1,0 m	•	•	€ 23,50	€ 27,95	090 78 051
	F9	0,9 m	•	•	€ 21,25	€ 25,30	090 78 050
		3,0 m	•	•	€ 63,70	€ 75,80	090 78 098
		2,7 m	•	•	€ 57,30	€ 68,20	090 78 095
	F6	1,0 m	•	•	€ 22,60	€ 26,90	090 78 091
		0,9 m	•	•	€ 20,50	€ 24,40	090 78 090
		3,0 m	•	•	€ 65,95	€ 78,50	090 78 068
	F2	2,7 m	•	•	€ 59,35	€ 70,65	090 78 065
		1,0 m	•	•	€ 23,50	€ 27,95	090 78 061
		0,9 m	•	•	€ 21,25	€ 25,30	090 78 060
	F6	3,0 m	•	•	€ 65,95	€ 78,50	090 78 028
		2,7 m	•	•	€ 59,35	€ 70,65	090 78 025
		1,0 m	•	•	€ 23,50	€ 27,95	090 78 021
	F2	0,9 m	•	•	€ 21,25	€ 25,30	090 78 020

Artikel	Farben	Länge	Version	SB	Preis/Stück	unit price	Bestell-Nr.
article	colour	length	version	SB	exkl. MwSt.	inkl. MwSt.	order no.
577	H30	3,0 m	•	•	€ 67,50	€ 80,35	064 76 308
		2,7 m	•	•	€ 60,75	€ 72,30	064 76 305
		1,0 m	•	•	€ 23,20	€ 27,60	064 76 301
	H33	0,9 m	•	•	€ 21,30	€ 25,35	064 76 300
		3,0 m	•	•	€ 67,50	€ 80,35	064 76 338
		2,7 m	•	•	€ 60,75	€ 72,30	064 76 335
	H61	1,0 m	•	•	€ 23,20	€ 27,60	064 76 331
		0,9 m	•	•	€ 21,30	€ 25,35	064 76 330
		3,0 m	•	•	€ 67,50	€ 80,35	064 76 618
	H62	2,7 m	•	•	€ 60,75	€ 72,30	064 76 615
		1,0 m	•	•	€ 23,20	€ 27,60	064 76 611
		0,9 m	•	•	€ 21,30	€ 25,35	064 76 610
	H63	3,0 m	•	•	€ 67,50	€ 80,35	064 76 628
		2,7 m	•	•	€ 60,75	€ 72,30	064 76 625
		1,0 m	•	•	€ 23,20	€ 27,60	064 76 621
	H64	0,9 m	•	•	€ 21,30	€ 25,35	064 76 620
		3,0 m	•	•	€ 67,50	€ 80,35	064 76 638
		2,7 m	•	•	€ 60,75	€ 72,30	064 76 635
	H63	1,0 m	•	•	€ 23,20	€ 27,60	064 76 631
		0,9 m	•	•	€ 21,30	€ 25,35	064 76 630
		3,0 m	•	•	€ 67,50	€ 80,35	064 76 648
H64	2,7 m	•	•	€ 60,75	€ 72,30	064 76 645	
	1,0 m	•	•	€ 23,20	€ 27,60	064 76 641	
	0,9 m	•	•	€ 21,30	€ 25,35	064 76 640	
578	F4	3,0 m	•	•	€ 55,80	€ 66,40	064 77 048
		2,7 m	•	•	€ 50,25	€ 59,80	064 77 045
		1,0 m	•	•	€ 19,50	€ 23,20	064 77 041
	F5	0,9 m	•	•	€ 17,70	€ 21,05	064 77 040
		3,0 m	•	•	€ 59,20	€ 70,45	064 77 058
		2,7 m	•	•	€ 53,25	€ 63,35	064 77 055
	F9	1,0 m	•	•	€ 20,55	€ 24,45	064 77 051
		0,9 m	•	•	€ 18,70	€ 22,25	064 77 050
		3,0 m	•	•	€ 55,80	€ 66,40	064 77 098
	F6	2,7 m	•	•	€ 50,25	€ 59,80	064 77 095
		1,0 m	•	•	€ 19,50	€ 23,20	064 77 091
		0,9 m	•	•	€ 17,70	€ 21,05	064 77 090
	F6	3,0 m	•	•	€ 59,20	€ 70,45	064 77 068
		2,7 m	•	•	€ 53,25	€ 63,35	064 77 065
		1,0 m	•	•	€ 20,55	€ 24,45	064 77 061
	F2G	0,9 m	•	•	€ 18,70	€ 22,25	064 77 060
		3,0 m	•	•	€ 63,25	€ 75,25	064 77 028
		2,7 m	•	•	€ 56,95	€ 67,75	064 77 025
	H30	1,0 m	•	•	€ 21,90	€ 26,05	064 77 021
		0,9 m	•	•	€ 20,10	€ 23,90	064 77 020
		3,0 m	•	•	€ 66,60	€ 79,25	064 77 308
H33	2,7 m	•	•	€ 59,95	€ 71,35	064 77 305	
	1,0 m	•	•	€ 22,60	€ 26,90	064 77 301	
	0,9 m	•	•	€ 20,55	€ 24,45	064 77 300	
H61	3,0 m	•	•	€ 66,60	€ 79,25	064 77 338	
	2,7 m	•	•	€ 59,95	€ 71,35	064 77 335	
	1,0 m	•	•	€ 22,60	€ 26,90	064 77 331	
H62	0,9 m	•	•	€ 20,55	€ 24,45	064 77 330	
	3,0 m	•	•	€ 66,60	€ 79,25	064 77 618	
	2,7 m	•	•	€ 59,95	€ 71,35	064 77 615	
H63	1,0 m	•	•	€ 22,60	€ 26,90	064 77 611	
	0,9 m	•	•	€ 20,55	€ 24,45	064 77 610	
	3,0 m	•	•	€ 66,60	€ 79,25	064 77 628	
H64	2,7 m	•	•	€ 59,95	€ 71,35	064 77 625	
	1,0 m	•	•	€ 22,60	€ 26,90	064 77 621	
	0,9 m	•	•	€ 20,55	€ 24,45	064 77 620	
H63	3,0 m	•	•	€ 66,60	€ 79,25	064 77 638	
	2,7 m	•	•	€ 59,95	€ 71,35	064 77 635	
	1,0 m	•	•	€ 22,60	€ 26,90	064 77 631	
H64	0,9 m	•	•	€ 20,55	€ 24,45	064 77 630	
	3,0 m	•	•	€ 66,60	€ 79,25	064 77 648	
	2,7 m	•	•	€ 59,95	€ 71,35	064 77 645	
F4	1,0 m	•	•	€ 22,60	€ 26,90	064 77 641	
	0,9 m	•	•	€ 20,55	€ 24,45	064 77 640	
	3,0 m	•	•	€ 54,70	€ 65,10	064 78 048	
F5	2,7 m	•	•	€ 49,20	€ 58,55	064 78 045	
	1,0 m	•	•	€ 19,00	€ 22,60	064 78 041	
	0,9 m	•	•	€ 17,20	€ 20,45	064 78 040	
F9	3,0 m	•	•	€ 57,40	€ 68,30	064 78 058	
	2,7 m	•	•	€ 51,70	€ 61,50	064 78 055	
	1,0 m	•	•	€ 19,95	€ 23,75	064 78 051	
F6	0,9 m	•	•	€ 18,25	€ 21,70	064 78 050	
	3,0 m	•	•	€ 54,70	€ 65,10	064 78 098	
	2,7 m	•	•	€ 49,20	€ 58,55	064 78 095	
F6	1,0 m	•	•	€ 19,00	€ 22,60	064 78 091	
	0,9 m	•	•	€ 17,20	€ 20,45	064 78 090	
	3,0 m	•	•	€ 57,40	€ 68,30	064 78 068	
F6	2,7 m	•	•	€ 51,70	€ 61,50	064 78 065	
	1,0 m	•	•	€ 19,95	€ 23,75	064 78 061	
	0,9 m	•	•	€ 18,25	€ 21,70	064 78 060	



Artikel	Farben	Länge	Version	SB	Preis/Stück	unit price	Bestell-Nr.
article	colour	length	version	SB	exkl. MwSt.	inkl. MwSt.	order no.
576	F4	3,0 m	•	•	€ 57,60	€ 68,55	064 76 048
		2,7 m	•	•	€ 51,85	€ 61,70	064 76 045
		1,0 m	•	•	€ 20,10	€ 23,90	064 76 041
	F5	0,9 m	•	•	€ 18,40	€ 21,90	064 76 040
		3,0 m	•	•	€ 61,20	€ 72,85	064 76 058
		2,7 m	•	•	€ 55,05	€ 65,50	064 76 055
	F9	1,0 m	•	•	€ 21,25	€ 25,30	064 76 051
		0,9 m	•	•	€ 19,30	€ 22,95	064 76 050
		3,0 m	•	•	€ 57,60	€ 68,55	064 76 098
	F6	2,7 m	•	•	€ 51,85	€ 61,70	064 76 095
		1,0 m	•	•	€ 20,10	€ 23,90	064 76 091
		0,9 m	•	•	€ 18,40	€ 21,90	064 76 090
	F2G	3,0 m	•	•	€ 61,20	€ 72,85	064 76 068
		2,7 m	•	•	€ 55,05	€ 65,50	064 76 065
		1,0 m	•	•	€ 21,25	€ 25,30	064 76 061
	F2G	0,9 m	•	•	€ 19,30	€ 22,95	064 76 060
		3,0 m	•	•	€ 65,70	€ 78,20	064 76 028
		2,7 m	•	•	€ 59,10	€ 70,35	064 76 025
	F2G	1,0 m	•	•	€ 22,65	€ 26,95	064 76 021
		0,9 m	•	•	€ 20,85	€ 24,80	064 76 020

Artikel	Farben	Länge	Version	SB	Preis/Stück	unit price	Bestell-Nr.
article	colour	length	version	SB	exkl. MwSt.	inkl. MwSt.	order no.
F2G		3,0 m	•		€ 62,10	€ 73,90	064 78 028
		2,7 m	•		€ 55,90	€ 66,50	064 78 025
		1,0 m	•		€ 21,45	€ 25,55	064 78 021
H30		0,9 m	•		€ 19,75	€ 23,50	064 78 020
		3,0 m	•		€ 63,90	€ 76,05	064 78 308
		2,7 m	•		€ 57,55	€ 68,50	064 78 305
H33		1,0 m	•		€ 22,15	€ 26,35	064 78 301
		0,9 m	•		€ 20,20	€ 24,05	064 78 300
		3,0 m	•		€ 63,90	€ 76,05	064 78 338
H61		2,7 m	•		€ 57,55	€ 68,50	064 78 335
		1,0 m	•		€ 22,15	€ 26,35	064 78 331
		0,9 m	•		€ 20,20	€ 24,05	064 78 330
H62		3,0 m	•		€ 63,90	€ 76,05	064 78 618
		2,7 m	•		€ 57,55	€ 68,50	064 78 615
		1,0 m	•		€ 22,15	€ 26,35	064 78 611
H63		0,9 m	•		€ 20,20	€ 24,05	064 78 610
		3,0 m	•		€ 63,90	€ 76,05	064 78 628
		2,7 m	•		€ 57,55	€ 68,50	064 78 625
H64		1,0 m	•		€ 22,15	€ 26,35	064 78 621
		0,9 m	•		€ 20,20	€ 24,05	064 78 620
		3,0 m	•		€ 63,90	€ 76,05	064 78 638
H63		2,7 m	•		€ 57,55	€ 68,50	064 78 635
		1,0 m	•		€ 22,15	€ 26,35	064 78 631
		0,9 m	•		€ 20,20	€ 24,05	064 78 630
H64		3,0 m	•		€ 63,90	€ 76,05	064 78 648
		2,7 m	•		€ 57,55	€ 68,50	064 78 645
		1,0 m	•		€ 22,15	€ 26,35	064 78 641
		0,9 m	•		€ 20,20	€ 24,05	064 78 640

Design-Clip® XL - breites Topprofil
Design-Clip® XL - wide Top Profile

576 XL	F4	3,0 m	•		€ 68,40	€ 81,40	06476048-XL
		2,0 m	•		€ 46,50	€ 55,35	06476043-XL
		1,0 m	•		€ 23,65	€ 28,15	06476041-XL
F9		3,0 m	•		€ 68,40	€ 81,40	06476098-XL
		2,0 m	•		€ 46,50	€ 55,35	06476093-XL
		1,0 m	•		€ 23,65	€ 28,15	06476091-XL
F6		3,0 m	•		€ 71,80	€ 85,45	06476068-XL
		2,0 m	•		€ 48,75	€ 58,00	06476063-XL
		1,0 m	•		€ 24,70	€ 29,40	06476061-XL
F2G		3,0 m	•		€ 76,30	€ 90,80	06476028-XL
		2,0 m	•		€ 51,90	€ 61,75	06476023-XL
		1,0 m	•		€ 26,25	€ 31,25	06476021-XL
577 XL	F4	3,0 m	•		€ 60,75	€ 72,30	06477048-XL
		2,0 m	•		€ 41,40	€ 49,25	06477043-XL
		1,0 m	•		€ 21,00	€ 25,00	06477041-XL
F9		3,0 m	•		€ 60,75	€ 72,30	06477098-XL
		2,0 m	•		€ 41,40	€ 49,25	06477093-XL
		1,0 m	•		€ 21,00	€ 25,00	06477091-XL
F6		3,0 m	•		€ 63,90	€ 76,05	06477068-XL
		2,0 m	•		€ 43,65	€ 51,95	06477063-XL
		1,0 m	•		€ 22,15	€ 26,35	06477061-XL
F2G		3,0 m	•		€ 67,95	€ 80,85	06477028-XL
		2,0 m	•		€ 46,35	€ 55,15	06477023-XL
		1,0 m	•		€ 23,50	€ 27,95	06477021-XL
578 XL	F4	3,0 m	•		€ 61,65	€ 73,35	06478048-XL
		2,0 m	•		€ 42,00	€ 50,00	06478043-XL
		1,0 m	•		€ 21,30	€ 25,35	06478041-XL
F9		3,0 m	•		€ 61,65	€ 73,35	06478098-XL
		2,0 m	•		€ 42,00	€ 50,00	06478093-XL
		1,0 m	•		€ 21,30	€ 25,35	06478091-XL
F6		3,0 m	•		€ 64,35	€ 76,60	06478068-XL
		2,0 m	•		€ 43,95	€ 52,30	06478063-XL
		1,0 m	•		€ 22,30	€ 26,55	06478061-XL
F2G		3,0 m	•		€ 69,10	€ 82,25	06478028-XL
		2,0 m	•		€ 46,95	€ 55,85	06478023-XL
		1,0 m	•		€ 23,85	€ 28,40	06478021-XL



Artikel	Farben	Länge	Version	SB	Preis/Stück	unit price	Bestell-Nr.
article	colour	length	version	SB	exkl. MwSt.	inkl. MwSt.	order no.
886	F3	3,0 m	•		€ 102,40	€ 121,85	098 86 038
		2,7 m	•		€ 92,20	€ 109,70	098 86 035
		1,0 m	•		€ 35,50	€ 42,25	098 86 031
	F4	0,9 m	•		€ 32,05	€ 38,15	098 86 030
		3,0 m	•		€ 102,40	€ 121,85	098 86 048
		2,7 m	•		€ 92,20	€ 109,70	098 86 045
	F5	1,0 m	•		€ 35,50	€ 42,25	098 86 041
		0,9 m	•		€ 32,05	€ 38,15	098 86 040
		3,0 m	•		€ 104,85	€ 124,75	098 86 058
	F9	2,7 m	•		€ 94,35	€ 112,30	098 86 055
		1,0 m	•		€ 36,55	€ 43,50	098 86 051
		0,9 m	•		€ 32,95	€ 39,20	098 86 050
F6	3,0 m	•		€ 102,40	€ 121,85	098 86 098	
	2,7 m	•		€ 92,20	€ 109,70	098 86 095	
	1,0 m	•		€ 35,50	€ 42,25	098 86 091	
F2	0,9 m	•		€ 32,05	€ 38,15	098 86 090	
	3,0 m	•		€ 104,85	€ 124,75	098 86 068	
	2,7 m	•		€ 94,35	€ 112,30	098 86 065	
287 N	F3	1,0 m	•		€ 36,55	€ 43,50	098 86 061
		0,9 m	•		€ 32,95	€ 39,20	098 86 060
		3,0 m	•		€ 104,85	€ 124,75	098 86 028
F4		2,7 m	•		€ 94,35	€ 112,30	098 86 025
		1,0 m	•		€ 36,55	€ 43,50	098 86 021
		0,9 m	•		€ 32,95	€ 39,20	098 86 020
F5		3,0 m	N		€ 78,30	€ 93,20	07987038-N
		2,7 m	N		€ 70,50	€ 83,90	07987035-N
		1,0 m	N		€ 27,55	€ 32,80	07987031-N
F9		0,9 m	N		€ 24,85	€ 29,55	07987030-N
		3,0 m	N		€ 78,30	€ 93,20	07987048-N
		2,7 m	N		€ 70,50	€ 83,90	07987045-N
F6		1,0 m	N		€ 27,55	€ 32,80	07987041-N
		0,9 m	N		€ 24,85	€ 29,55	07987040-N
		3,0 m	N		€ 80,35	€ 95,60	07987058-N
F2		2,7 m	N		€ 72,30	€ 86,05	07987055-N
		1,0 m	N		€ 28,35	€ 33,75	07987051-N
		0,9 m	N		€ 25,50	€ 30,35	07987050-N
F9		3,0 m	N		€ 78,30	€ 93,20	07987098-N
		2,7 m	N		€ 70,50	€ 83,90	07987095-N
		1,0 m	N		€ 27,55	€ 32,80	07987091-N
F6		0,9 m	N		€ 24,85	€ 29,55	07987090-N
		3,0 m	N		€ 80,35	€ 95,60	07987068-N
		2,7 m	N		€ 72,30	€ 86,05	07987065-N
F2		1,0 m	N		€ 28,35	€ 33,75	07987061-N
		0,9 m	N		€ 25,50	€ 30,35	07987060-N
		3,0 m	N		€ 80,35	€ 95,60	07987028-N
888	F3	2,7 m	N		€ 72,30	€ 86,05	07987025-N
		1,0 m	N		€ 28,35	€ 33,75	07987021-N
		0,9 m	N		€ 25,50	€ 30,35	07987020-N
F4		3,0 m	•		€ 89,80	€ 106,85	098 88 038
		2,7 m	•		€ 80,80	€ 96,15	098 88 035
		1,0 m	•		€ 31,30	€ 37,25	098 88 031
F5		0,9 m	•		€ 28,30	€ 33,70	098 88 030
		3,0 m	•		€ 89,80	€ 106,85	098 88 048
		2,7 m	•		€ 80,80	€ 96,15	098 88 045
F9		1,0 m	•		€ 31,30	€ 37,25	098 88 041
		0,9 m	•		€ 28,30	€ 33,70	098 88 040
		3,0 m	•		€ 92,95	€ 110,60	098 88 058
F6		2,7 m	•		€ 83,65	€ 99,55	098 88 055
		1,0 m	•		€ 32,50	€ 38,70	098 88 051
		0,9 m	•		€ 29,25	€ 34,80	098 88 050
F2		3,0 m	•		€ 89,80	€ 106,85	098 88 098
		2,7 m	•		€ 80,80	€ 96,15	098 88 095
		1,0 m	•		€ 31,30	€ 37,25	098 88 091
F9		0,9 m	•		€ 28,30	€ 33,70	098 88 090
		3,0 m	•		€ 92,95	€ 110,60	098 88 068
		2,7 m	•		€ 83,65	€ 99,55	098 88 065
F6		1,0 m	•		€ 32,50	€ 38,70	098 88 061
		0,9 m	•		€ 29,25	€ 34,80	098 88 060
		3,0 m	•		€ 92,95	€ 110,60	098 88 028
F2		2,7 m	•		€ 83,65	€ 99,55	098 88 025
		1,0 m	•		€ 32,50	€ 38,70	098 88 021
		0,9 m	•		€ 29,25	€ 34,80	098 88 020



Artikel	Farben	Länge	Version	SB	Preis/Stück		Bestell-Nr.
					unit price	unit price	
article	colour	length	version	SB	exkl. MwSt.	inkl. MwSt.	order no.
286	F4	3,0 m	•	€ 88,90	€ 105,80	079 86 048	
		2,7 m	•	€ 80,05	€ 95,25	079 86 045	
		1,0 m	•	€ 31,00	€ 36,90	079 86 041	
	F5	3,0 m	•	€ 28,05	€ 33,40	079 86 040	
		2,7 m	•	€ 92,05	€ 109,55	079 86 058	
		1,0 m	•	€ 82,80	€ 98,55	079 86 055	
	F9	3,0 m	•	€ 32,20	€ 38,30	079 86 051	
		2,7 m	•	€ 29,05	€ 34,55	079 86 050	
		1,0 m	•	€ 88,90	€ 105,80	079 86 098	
	F6	3,0 m	•	€ 80,05	€ 95,25	079 86 095	
		2,7 m	•	€ 31,00	€ 36,90	079 86 091	
		1,0 m	•	€ 28,05	€ 33,40	079 86 090	
	F2	3,0 m	•	€ 92,05	€ 109,55	079 86 068	
		2,7 m	•	€ 82,80	€ 98,55	079 86 065	
		1,0 m	•	€ 32,20	€ 38,30	079 86 061	
	F4	3,0 m	•	€ 29,05	€ 34,55	079 86 060	
		2,7 m	•	€ 92,05	€ 109,55	079 86 028	
		1,0 m	•	€ 82,80	€ 98,55	079 86 025	
	F5	3,0 m	•	€ 32,20	€ 38,30	079 86 021	
		2,7 m	•	€ 29,05	€ 34,55	079 86 020	
		1,0 m	•	€ 72,45	€ 86,20	079 87 048	
	F9	3,0 m	•	€ 65,20	€ 77,60	079 87 045	
		2,7 m	•	€ 25,60	€ 30,45	079 87 041	
		1,0 m	•	€ 23,10	€ 27,50	079 87 040	
F6	3,0 m	•	€ 74,50	€ 88,65	079 87 058		
	2,7 m	•	€ 67,05	€ 79,80	079 87 055		
	1,0 m	•	€ 26,25	€ 31,25	079 87 051		
F2	3,0 m	•	€ 23,70	€ 28,20	079 87 050		
	2,7 m	•	€ 72,45	€ 86,20	079 87 098		
	1,0 m	•	€ 65,20	€ 77,60	079 87 095		
F5	3,0 m	•	€ 25,60	€ 30,45	079 87 091		
	2,7 m	•	€ 23,10	€ 27,50	079 87 090		
	1,0 m	•	€ 74,50	€ 88,65	079 87 068		
F9	3,0 m	•	€ 67,05	€ 79,80	079 87 065		
	2,7 m	•	€ 26,25	€ 31,25	079 87 061		
	1,0 m	•	€ 23,70	€ 28,20	079 87 060		
F6	3,0 m	•	€ 74,50	€ 88,65	079 87 028		
	2,7 m	•	€ 67,05	€ 79,80	079 87 025		
	1,0 m	•	€ 26,25	€ 31,25	079 87 021		
F2	3,0 m	•	€ 23,70	€ 28,20	079 87 020		
	2,7 m	•	€ 79,65	€ 94,80	079 88 048		
	1,0 m	•	€ 71,70	€ 85,30	079 88 045		
F5	3,0 m	•	€ 28,00	€ 33,30	079 88 041		
	2,7 m	•	€ 25,20	€ 30,00	079 88 040		
	1,0 m	•	€ 82,60	€ 98,30	079 88 058		
F9	3,0 m	•	€ 74,35	€ 88,50	079 88 055		
	2,7 m	•	€ 28,95	€ 34,45	079 88 051		
	1,0 m	•	€ 26,05	€ 31,00	079 88 050		
F6	3,0 m	•	€ 79,65	€ 94,80	079 88 098		
	2,7 m	•	€ 71,70	€ 85,30	079 88 095		
	1,0 m	•	€ 28,00	€ 33,30	079 88 091		
F2	3,0 m	•	€ 25,20	€ 30,00	079 88 090		
	2,7 m	•	€ 82,60	€ 98,30	079 88 068		
	1,0 m	•	€ 74,35	€ 88,50	079 88 065		
F5	3,0 m	•	€ 28,95	€ 34,45	079 88 061		
	2,7 m	•	€ 26,05	€ 31,00	079 88 060		
	1,0 m	•	€ 82,60	€ 98,30	079 88 028		
F9	3,0 m	•	€ 74,35	€ 88,50	079 88 025		
	2,7 m	•	€ 28,95	€ 34,45	079 88 021		
	1,0 m	•	€ 26,05	€ 31,00	079 88 020		
PPS®-Kreuze für / PPS®-Crosses for PPS®-Champion							
287 IE	F4	•	€ 64,60	€ 76,85	079 87 449		
	F2	•	€ 64,75	€ 77,05	079 87 429		
287 AE	F4	•	€ 64,60	€ 76,85	079 87 349		
	F2	•	€ 64,75	€ 77,05	079 87 329		
288 EC	F4	•	€ 65,05	€ 77,40	079 88 849		
	F2	•	€ 65,20	€ 77,60	079 88 829		
288 FK	F4	•	€ 89,95	€ 107,05	079 88 949		
	F2	•	€ 90,25	€ 107,40	079 88 929		

Artikel	Farben	Länge	Version	SB	Preis/Stück	unit price	Bestell-Nr.
article	colour	length	version	SB	exkl. MwSt.	inkl. MwSt.	order no.

PPS®-Champion smart

PPS®-Lifter auf Seite 203 / PPS®-Lifter see page 203

256	F3	3,0 m	•	€ 90,60	€ 107,80	079 56 038
		2,7 m	•	€ 81,60	€ 97,10	079 56 035
		1,0 m	•	€ 31,60	€ 37,60	079 56 031
	F4	3,0 m	•	€ 90,60	€ 107,80	079 56 048
		2,7 m	•	€ 81,60	€ 97,10	079 56 045
		1,0 m	•	€ 31,60	€ 37,60	079 56 041
	F9	3,0 m	•	€ 90,60	€ 107,80	079 56 098
		2,7 m	•	€ 81,60	€ 97,10	079 56 095
		1,0 m	•	€ 31,60	€ 37,60	079 56 091
	F2G	3,0 m	•	€ 98,35	€ 117,05	079 56 028
		2,7 m	•	€ 88,50	€ 105,30	079 56 025
		1,0 m	•	€ 34,20	€ 40,70	079 56 021
257	F3	3,0 m	•	€ 73,80	€ 87,80	079 57 038
		2,7 m	•	€ 66,40	€ 79,00	079 57 035
		1,0 m	•	€ 26,10	€ 31,05	079 57 031
	F4	3,0 m	•	€ 73,80	€ 87,80	079 57 048
		2,7 m	•	€ 66,40	€ 79,00	079 57 045
		1,0 m	•	€ 26,10	€ 31,05	079 57 041
	F9	3,0 m	•	€ 73,80	€ 87,80	079 57 098
		2,7 m	•	€ 66,40	€ 79,00	079 57 095
		1,0 m	•	€ 26,10	€ 31,05	079 57 091
	F2G	3,0 m	•	€ 80,35	€ 95,60	079 57 028
		2,7 m	•	€ 72,30	€ 86,05	079 57 025
		1,0 m	•	€ 28,20	€ 33,55	079 57 021
258	F3	3,0 m	•	€ 81,30	€ 96,75	079 58 038
		2,7 m	•	€ 73,20	€ 87,10	079 58 035
		1,0 m	•	€ 28,50	€ 33,90	079 58 031
	F4	3,0 m	•	€ 81,30	€ 96,75	079 58 048
		2,7 m	•	€ 73,20	€ 87,10	079 58 045
		1,0 m	•	€ 28,50	€ 33,90	079 58 041
	F9	3,0 m	•	€ 81,30	€ 96,75	079 58 098
		2,7 m	•	€ 73,20	€ 87,10	079 58 095
		1,0 m	•	€ 28,50	€ 33,90	079 58 091
	F2G	3,0 m	•	€ 88,75	€ 105,60	079 58 028
		2,7 m	•	€ 79,90	€ 95,10	079 58 025
		1,0 m	•	€ 31,00	€ 36,90	079 58 021

PPS®-Champion SK

PPS®-Lifter auf Seite 203 / PPS®-Lifter see page 203

286 SK	F4	3,0 m	SK	•	€ 116,55	€ 138,70	079 96 048
		2,7 m	SK	•	€ 104,95	€ 124,90	079 96 045
		1,0 m	SK	•	€ 41,05	€ 48,85	079 96 041
	F2	3,0 m	SK	•	€ 37,00	€ 44,05	079 96 040
		2,7 m	SK	•	€ 119,70	€ 142,45	079 96 028
		1,0 m	SK	•	€ 107,70	€ 128,15	079 96 025
	F9	3,0 m	SK	•	€ 42,10	€ 50,10	079 96 021
		2,7 m	SK	•	€ 37,80	€ 45,00	079 96 020
		1,0 m	SK	•	€ 103,75	€ 123,45	079 97 048
287 N/SK	F4	2,7 m	N/SK	•	€ 93,40	€ 111,15	079 97 045
		1,0 m	N/SK	•	€ 36,75	€ 43,75	079 97 041
		0,9 m	N/SK	•	€ 33,00	€ 39,25	079 97 040
F2	3,0 m	N/SK	•	€ 106,00	€ 126,15	079 97 028	
	2,7 m	N/SK	•	€ 95,40	€ 113,55	079 97 025	
	1,0 m	N/SK	•	€ 37,60	€ 44,75	079 97 021	
288 SK	F4	3,0 m	SK	•	€ 107,10	€ 127,45	079 98 048
		2,7 m	SK	•	€ 96,40	€ 114,70	079 98 045
		1,0 m	SK	•	€ 37,80	€ 45,00	079 98 041
F2	3,0 m	SK	•	€ 34,00	€ 40,45	079 98 040	
	2,7 m	SK	•	€ 110,25	€ 131,20	079 98 028	
	1,0 m	SK	•	€ 99,25	€ 118,10	079 98 025	
F9	3,0 m	SK	•	€ 38,70	€ 46,05	079 98 021	
	0,9 m	SK	•	€ 34,80	€ 41,40	079 98 020	

PPS®-Lifter			
+5/+10 mm*	10 x 6 St./pcs.	8,80 €	10,45 €
+7/+14 mm**	10 x 6 St./pcs.	8,80 €	10,45 €
Hartholzzulage mit Filz / hardwood log with felt			
		3,30 €	3,95 €
			146 02 018

* für PPS-Champion flex, PPS-Champion, PPS-Champion SK, PPS-Champion smart, PPS-Champion Star, PPS-Allrounder, PPS-AS und PPS-Magic
 ** für PPS-Champion XXL und PPS-Champion XXL S



PPS®-Champion XXL / XXL S

PPS®-Lifter auf Seite 203 / PPS®-Lifter see page 203

Artikel	Farben	Länge	Version SB	Preis/Stück	unit price	Bestell-Nr.
article	colour	length	version SB	exkl. MwSt. excl. VAT	inkl. MwSt. incl. VAT	order no.
386 XXL	F4	3,0 m	•	€ 111,40	€ 132,55	081 86 048
		2,7 m	•	€ 100,30	€ 119,35	081 86 045
		1,0 m	•	€ 38,65	€ 46,00	081 86 041
	F5	3,0 m	•	€ 114,55	€ 136,30	081 86 058
		2,7 m	•	€ 103,05	€ 122,65	081 86 055
		1,0 m	•	€ 39,85	€ 47,40	081 86 051
	F9	3,0 m	•	€ 111,40	€ 132,55	081 86 098
		2,7 m	•	€ 100,30	€ 119,35	081 86 095
		1,0 m	•	€ 38,65	€ 46,00	081 86 091
	F6	3,0 m	•	€ 114,55	€ 136,30	081 86 068
		2,7 m	•	€ 103,05	€ 122,65	081 86 065
		1,0 m	•	€ 39,85	€ 47,40	081 86 061
F2	3,0 m	•	€ 114,55	€ 136,30	081 86 028	
	2,7 m	•	€ 103,05	€ 122,65	081 86 025	
	1,0 m	•	€ 39,85	€ 47,40	081 86 021	
387 XXL	F4	3,0 m	•	€ 93,15	€ 110,85	081 87 048
		2,7 m	•	€ 83,85	€ 99,80	081 87 045
		1,0 m	•	€ 32,55	€ 38,75	081 87 041
	F5	3,0 m	•	€ 95,85	€ 114,05	081 87 058
		2,7 m	•	€ 86,25	€ 102,65	081 87 055
		1,0 m	•	€ 33,30	€ 39,65	081 87 051
	F9	3,0 m	•	€ 93,15	€ 110,85	081 87 098
		2,7 m	•	€ 83,85	€ 99,80	081 87 095
		1,0 m	•	€ 32,55	€ 38,75	081 87 091
	F6	3,0 m	•	€ 95,85	€ 114,05	081 87 068
		2,7 m	•	€ 86,25	€ 102,65	081 87 065
		1,0 m	•	€ 33,30	€ 39,65	081 87 061
F2	3,0 m	•	€ 95,85	€ 114,05	081 87 028	
	2,7 m	•	€ 86,25	€ 102,65	081 87 025	
	1,0 m	•	€ 33,30	€ 39,65	081 87 021	
388 XXL	F4	3,0 m	•	€ 98,55	€ 117,25	081 88 048
		2,7 m	•	€ 88,75	€ 105,60	081 88 045
		1,0 m	•	€ 34,35	€ 40,90	081 88 041
	F5	3,0 m	•	€ 102,85	€ 122,40	081 88 058
		2,7 m	•	€ 92,55	€ 110,15	081 88 055
		1,0 m	•	€ 35,80	€ 42,60	081 88 051
	F9	3,0 m	•	€ 98,55	€ 117,25	081 88 098
		2,7 m	•	€ 88,75	€ 105,60	081 88 095
		1,0 m	•	€ 34,35	€ 40,90	081 88 091
	F6	3,0 m	•	€ 102,85	€ 122,40	081 88 068
		2,7 m	•	€ 92,55	€ 110,15	081 88 065
		1,0 m	•	€ 35,80	€ 42,60	081 88 061
F2	3,0 m	•	€ 102,85	€ 122,40	081 88 028	
	2,7 m	•	€ 92,55	€ 110,15	081 88 025	
	1,0 m	•	€ 35,80	€ 42,60	081 88 021	
		0,9 m	•	€ 32,35	€ 38,50	081 88 020

Artikel	Farben	Länge	Version SB	Preis/Stück	unit price	Bestell-Nr.
article	colour	length	version SB	exkl. MwSt. excl. VAT	inkl. MwSt. incl. VAT	order no.
PPS®-Kreuze für / PPS® Crosses for PPS®-Champion XXL						
387 XXL IE	F4	•	•	€ 65,70	€ 78,20	081 87 449
		•	•	€ 65,85	€ 78,35	081 87 429
387 XXL AE	F4	•	•	€ 65,70	€ 78,20	081 87 349
		•	•	€ 65,85	€ 78,35	081 87 329
388 XXL EC	F4	•	•	€ 66,00	€ 78,55	081 88 849
		•	•	€ 66,25	€ 78,85	081 88 829
388 XXL FK	F4	•	•	€ 92,05	€ 109,55	081 88 949
		•	•	€ 92,55	€ 110,15	081 88 929

PPS®-Champion XXL S

PPS®-Champion XXL S

386 XXL S	F4	3,0 m	•	€ 121,75	€ 144,90	085 86 048	
		2,7 m	•	€ 109,60	€ 130,40	085 86 045	
		1,0 m	•	€ 42,15	€ 50,15	085 86 041	
	F9	3,0 m	•	€ 121,75	€ 144,90	085 86 098	
		2,7 m	•	€ 109,60	€ 130,40	085 86 095	
		1,0 m	•	€ 42,15	€ 50,15	085 86 091	
	F2	3,0 m	•	€ 124,45	€ 148,10	085 86 028	
		2,7 m	•	€ 112,00	€ 133,30	085 86 025	
		1,0 m	•	€ 43,35	€ 51,60	085 86 021	
	387 XXL S	F4	3,0 m	•	€ 103,05	€ 122,65	085 87 048
			2,7 m	•	€ 92,80	€ 110,45	085 87 045
			1,0 m	•	€ 35,85	€ 42,65	085 87 041
F9		3,0 m	•	€ 103,05	€ 122,65	085 87 098	
		2,7 m	•	€ 92,80	€ 110,45	085 87 095	
		1,0 m	•	€ 35,85	€ 42,65	085 87 091	
F2		3,0 m	•	€ 105,75	€ 125,85	085 87 028	
		2,7 m	•	€ 95,20	€ 113,30	085 87 025	
		1,0 m	•	€ 36,75	€ 43,75	085 87 021	
388 XXL S		F4	3,0 m	•	€ 108,45	€ 129,05	085 88 048
			2,7 m	•	€ 97,60	€ 116,15	085 88 045
			1,0 m	•	€ 37,80	€ 45,00	085 88 041
	F9	3,0 m	•	€ 108,45	€ 129,05	085 88 098	
		2,7 m	•	€ 97,60	€ 116,15	085 88 095	
		1,0 m	•	€ 37,80	€ 45,00	085 88 091	
	F2	3,0 m	•	€ 113,20	€ 134,70	085 88 028	
		2,7 m	•	€ 101,85	€ 121,20	085 88 025	
		1,0 m	•	€ 39,25	€ 46,70	085 88 021	
			0,9 m	•	€ 33,15	€ 39,45	085 87 020
			0,9 m	•	€ 39,25	€ 46,70	085 88 020

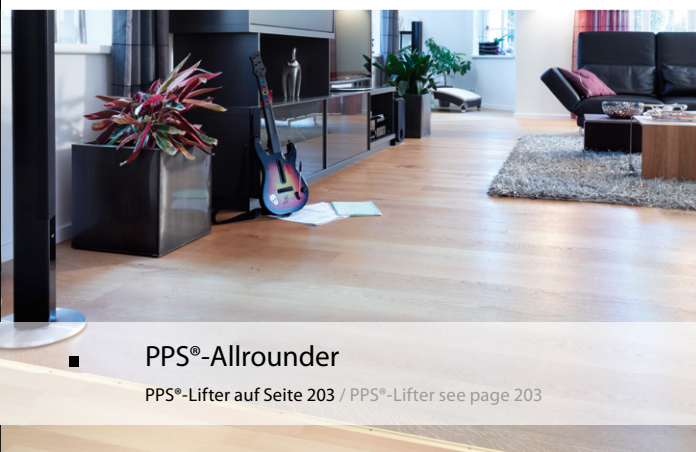

PPS®-Allrounder

PPS®-Lifter auf Seite 203 / PPS®-Lifter see page 203

Artikel	Farben	Länge	Version SB	Preis/Stück	unit price	Bestell-Nr.
article	colour	length	version SB	exkl. MwSt. excl. VAT	inkl. MwSt. incl. VAT	order no.
486	F4	3,0 m	•	€ 84,40	€ 100,45	077 86 048
		2,7 m	•	€ 76,00	€ 90,45	077 86 045
		1,0 m	•	€ 29,50	€ 35,10	077 86 041
		0,9 m	•	€ 26,65	€ 31,70	077 86 040

Artikel	Farben	Länge	Version	SB	Preis/Stück	unit price	Bestell-Nr.
article	colour	length	version	SB	exkl. MwSt.	inkl. MwSt.	order no.
F5		3,0 m	•		€ 87,10	€ 103,65	077 86 058
		2,7 m	•		€ 78,40	€ 93,30	077 86 055
		1,0 m	•		€ 30,40	€ 36,20	077 86 051
		0,9 m	•		€ 27,40	€ 32,60	077 86 050
F9		3,0 m	•		€ 84,40	€ 100,45	077 86 098
		2,7 m	•		€ 76,00	€ 90,45	077 86 095
		1,0 m	•		€ 29,50	€ 35,10	077 86 091
		0,9 m	•		€ 26,65	€ 31,70	077 86 090
F6		3,0 m	•		€ 87,10	€ 103,65	077 86 068
		2,7 m	•		€ 78,40	€ 93,30	077 86 065
		1,0 m	•		€ 30,40	€ 36,20	077 86 061
		0,9 m	•		€ 27,40	€ 32,60	077 86 060
F2		3,0 m	•		€ 87,10	€ 103,65	077 86 028
		2,7 m	•		€ 78,40	€ 93,30	077 86 025
		1,0 m	•		€ 30,40	€ 36,20	077 86 021
		0,9 m	•		€ 27,40	€ 32,60	077 86 020
487	F4	3,0 m	•		€ 69,30	€ 82,45	077 87 048
		2,7 m	•		€ 62,40	€ 74,25	077 87 045
		1,0 m	•		€ 24,40	€ 29,05	077 87 041
		0,9 m	•		€ 22,00	€ 26,20	077 87 040
F5		3,0 m	•		€ 71,35	€ 84,90	077 87 058
		2,7 m	•		€ 64,20	€ 76,40	077 87 055
		1,0 m	•		€ 25,15	€ 29,95	077 87 051
		0,9 m	•		€ 22,65	€ 26,95	077 87 050
F9		3,0 m	•		€ 69,30	€ 82,45	077 87 098
		2,7 m	•		€ 62,40	€ 74,25	077 87 095
		1,0 m	•		€ 24,40	€ 29,05	077 87 091
		0,9 m	•		€ 22,00	€ 26,20	077 87 090
F6		3,0 m	•		€ 71,35	€ 84,90	077 87 068
		2,7 m	•		€ 64,20	€ 76,40	077 87 065
		1,0 m	•		€ 25,15	€ 29,95	077 87 061
		0,9 m	•		€ 22,65	€ 26,95	077 87 060
F2		3,0 m	•		€ 71,35	€ 84,90	077 87 028
		2,7 m	•		€ 64,20	€ 76,40	077 87 025
		1,0 m	•		€ 25,15	€ 29,95	077 87 021
		0,9 m	•		€ 22,65	€ 26,95	077 87 020
488	F4	3,0 m	•		€ 74,50	€ 88,65	077 88 048
		2,7 m	•		€ 67,05	€ 79,80	077 88 045
		1,0 m	•		€ 26,20	€ 31,20	077 88 041
		0,9 m	•		€ 23,70	€ 28,20	077 88 040
F5		3,0 m	•		€ 77,85	€ 92,65	077 88 058
		2,7 m	•		€ 70,05	€ 83,35	077 88 055
		1,0 m	•		€ 27,25	€ 32,45	077 88 051
		0,9 m	•		€ 24,55	€ 29,20	077 88 050
F9		3,0 m	•		€ 74,50	€ 88,65	077 88 098
		2,7 m	•		€ 67,05	€ 79,80	077 88 095
		1,0 m	•		€ 26,20	€ 31,20	077 88 091
		0,9 m	•		€ 23,70	€ 28,20	077 88 090
F6		3,0 m	•		€ 77,85	€ 92,65	077 88 068
		2,7 m	•		€ 70,05	€ 83,35	077 88 065
		1,0 m	•		€ 27,25	€ 32,45	077 88 061
		0,9 m	•		€ 24,55	€ 29,20	077 88 060
F2		3,0 m	•		€ 77,85	€ 92,65	077 88 028
		2,7 m	•		€ 70,05	€ 83,35	077 88 025
		1,0 m	•		€ 27,25	€ 32,45	077 88 021
		0,9 m	•		€ 24,55	€ 29,20	077 88 020

PPS®-Kreuze für / PPS® Crosses for PPS®-Allrounder							
487 IE	F4	•			€ 64,30	€ 76,50	077 87 449
	F2	•			€ 64,50	€ 76,75	077 87 429
487 AE	F4	•			€ 64,30	€ 76,50	077 87 349
	F2	•			€ 64,50	€ 76,75	077 87 329
488 EC	F4	•			€ 64,75	€ 77,05	077 88 849
	F2	•			€ 64,90	€ 77,25	077 88 829
488 FK	F4	•			€ 89,25	€ 106,20	077 88 949
	F2	•			€ 89,55	€ 106,55	077 88 929



Artikel	Farben	Länge	Version	SB	Preis/Stück	unit price	Bestell-Nr.
article	colour	length	version	SB	exkl. MwSt.	inkl. MwSt.	order no.
386 AS	F4	3,0 m	•		€ 76,30	€ 90,80	082 86 048
		2,7 m	•		€ 68,65	€ 81,70	082 86 045
		1,0 m	•		€ 26,85	€ 31,95	082 86 041
	F5	3,0 m	•		€ 79,65	€ 94,80	082 86 058
		2,7 m	•		€ 71,70	€ 85,30	082 86 055
		1,0 m	•		€ 27,90	€ 33,20	082 86 051
	F9	3,0 m	•		€ 76,30	€ 90,80	082 86 098
		2,7 m	•		€ 68,65	€ 81,70	082 86 095
		1,0 m	•		€ 26,85	€ 31,95	082 86 091
	F6	3,0 m	•		€ 79,65	€ 94,80	082 86 068
		2,7 m	•		€ 71,70	€ 85,30	082 86 065
		1,0 m	•		€ 27,90	€ 33,20	082 86 061
F2	3,0 m	•		€ 79,65	€ 94,80	082 86 028	
	2,7 m	•		€ 71,70	€ 85,30	082 86 025	
	1,0 m	•		€ 27,90	€ 33,20	082 86 021	
387 AS	F4	3,0 m	•		€ 64,60	€ 76,85	082 87 048
		2,7 m	•		€ 58,15	€ 69,20	082 87 045
		1,0 m	•		€ 22,90	€ 27,25	082 87 041
	F5	3,0 m	•		€ 65,70	€ 78,20	082 87 058
		2,7 m	•		€ 59,10	€ 70,35	082 87 055
		1,0 m	•		€ 23,35	€ 27,80	082 87 051
	F9	3,0 m	•		€ 64,60	€ 76,85	082 87 098
		2,7 m	•		€ 58,15	€ 69,20	082 87 095
		1,0 m	•		€ 22,90	€ 27,25	082 87 091
	F6	3,0 m	•		€ 65,70	€ 78,20	082 87 068
		2,7 m	•		€ 59,10	€ 70,35	082 87 065
		1,0 m	•		€ 23,35	€ 27,80	082 87 061
F2	3,0 m	•		€ 65,70	€ 78,20	082 87 028	
	2,7 m	•		€ 59,10	€ 70,35	082 87 025	
	1,0 m	•		€ 23,35	€ 27,80	082 87 021	
388 AS	F4	3,0 m	•		€ 66,85	€ 79,55	082 88 048
		2,7 m	•		€ 60,15	€ 71,60	082 88 045
		1,0 m	•		€ 23,80	€ 28,30	082 88 041
	F5	3,0 m	•		€ 70,65	€ 84,05	082 88 058
		2,7 m	•		€ 63,60	€ 75,70	082 88 055
		1,0 m	•		€ 24,85	€ 29,55	082 88 051
	F9	3,0 m	•		€ 66,85	€ 79,55	082 88 098
		2,7 m	•		€ 60,15	€ 71,60	082 88 095
		1,0 m	•		€ 23,80	€ 28,30	082 88 091
	F6	3,0 m	•		€ 70,65	€ 84,05	082 88 068
		2,7 m	•		€ 63,60	€ 75,70	082 88 065
		1,0 m	•		€ 24,85	€ 29,55	082 88 061
F2	3,0 m	•		€ 70,65	€ 84,05	082 88 028	
	2,7 m	•		€ 63,60	€ 75,70	082 88 025	
	1,0 m	•		€ 24,85	€ 29,55	082 88 021	

PPS®-Kreuze für / PPS® Crosses for PPS®-AS							
387 AS IE	F4	•			€ 63,90	€ 76,05	082 87 449
	F2	•			€ 64,00	€ 76,15	082 87 429
387 AS AE	F4	•			€ 63,90	€ 76,05	082 87 349
	F2	•			€ 64,00	€ 76,15	082 87 329
388 AS EC	F4	•			€ 64,05	€ 76,20	082 88 849
	F2	•			€ 64,35	€ 76,60	082 88 829
388 AS FK	F4	•			€ 88,30	€ 105,10	082 88 949
	F2	•			€ 88,65	€ 105,50	082 88 929



PPS®-Magic

PPS®-Lifter auf Seite 203 / PPS®-Lifter see page 203



Euro-Clip®

Clip-Lifter auf Seite 208 / Clip-Lifter see page 208

Artikel	Farben	Länge	Version	SB	Preis/Stück	unit price	Bestell-Nr.
article	colour	length	version	SB	exkl. MwSt.	inkl. MwSt.	order no.
552	F4	2,7 m	•	€ 126,15	€ 150,10	097 52 045	
		0,9 m	•	€ 43,90	€ 52,25	097 52 040	
	F2	2,7 m	•	€ 138,75	€ 165,10	097 52 025	
		0,9 m	•	€ 48,00	€ 57,10	097 52 020	
550	F4	2,7 m	•	€ 110,40	€ 131,40	097 50 045	
		0,9 m	•	€ 38,55	€ 45,85	097 50 040	
	F2	2,7 m	•	€ 118,30	€ 140,80	097 50 025	
		0,9 m	•	€ 41,20	€ 49,05	097 50 020	
551	F4	2,7 m	•	€ 115,20	€ 137,10	097 51 045	
		0,9 m	•	€ 40,05	€ 47,65	097 51 040	
	F2	2,7 m	•	€ 123,15	€ 146,55	097 51 025	
		0,9 m	•	€ 42,85	€ 51,00	097 51 020	

Artikel	Farben	Länge	Version	SB	Preis/Stück	unit price	Bestell-Nr.
article	colour	length	version	SB	exkl. MwSt.	inkl. MwSt.	order no.
586 L	F4	3,0 m	•	€ 69,75	€ 83,00	061 86 048	
		2,7 m	•	€ 62,80	€ 74,75	061 86 045	
		1,0 m	•	€ 24,25	€ 28,85	061 86 041	
		0,9 m	•	€ 21,90	€ 26,05	061 86 040	
	F5	3,0 m	•	€ 72,90	€ 86,75	061 86 058	
		2,7 m	•	€ 65,65	€ 78,10	061 86 055	
		1,0 m	•	€ 25,15	€ 29,95	061 86 051	
		0,9 m	•	€ 22,65	€ 26,95	061 86 050	
	F9	3,0 m	•	€ 69,75	€ 83,00	061 86 098	
		2,7 m	•	€ 62,80	€ 74,75	061 86 095	
		1,0 m	•	€ 24,25	€ 28,85	061 86 091	
		0,9 m	•	€ 21,90	€ 26,05	061 86 090	
	F6	3,0 m	•	€ 72,90	€ 86,75	061 86 068	
		2,7 m	•	€ 65,65	€ 78,10	061 86 065	
		1,0 m	•	€ 25,15	€ 29,95	061 86 061	
		0,9 m	•	€ 22,65	€ 26,95	061 86 060	
	F2	3,0 m	•	€ 72,90	€ 86,75	061 86 028	
		2,7 m	•	€ 65,65	€ 78,10	061 86 025	
		1,0 m	•	€ 25,15	€ 29,95	061 86 021	
		0,9 m	•	€ 22,65	€ 26,95	061 86 020	
	H20	3,0 m	•	€ 80,55	€ 95,85	061 86 208	
		2,7 m	•	€ 72,55	€ 86,35	061 86 205	
		1,0 m	•	€ 27,45	€ 32,65	061 86 201	
		0,9 m	•	€ 24,90	€ 29,65	061 86 200	
	H22	3,0 m	•	€ 80,55	€ 95,85	061 86 228	
		2,7 m	•	€ 72,55	€ 86,35	061 86 225	
		1,0 m	•	€ 27,45	€ 32,65	061 86 221	
		0,9 m	•	€ 24,90	€ 29,65	061 86 220	
	H30	3,0 m	•	€ 80,55	€ 95,85	061 86 308	
		2,7 m	•	€ 72,55	€ 86,35	061 86 305	
		1,0 m	•	€ 27,45	€ 32,65	061 86 301	
		0,9 m	•	€ 24,90	€ 29,65	061 86 300	
	H31	3,0 m	•	€ 80,55	€ 95,85	061 86 318	
		2,7 m	•	€ 72,55	€ 86,35	061 86 315	
		1,0 m	•	€ 27,45	€ 32,65	061 86 311	
		0,9 m	•	€ 24,90	€ 29,65	061 86 310	
	H33	3,0 m	•	€ 80,55	€ 95,85	061 86 338	
		2,7 m	•	€ 72,55	€ 86,35	061 86 335	
		1,0 m	•	€ 27,45	€ 32,65	061 86 331	
		0,9 m	•	€ 24,90	€ 29,65	061 86 330	
	H40	3,0 m	•	€ 80,55	€ 95,85	061 86 408	
		2,7 m	•	€ 72,55	€ 86,35	061 86 405	
		1,0 m	•	€ 27,45	€ 32,65	061 86 401	
		0,9 m	•	€ 24,90	€ 29,65	061 86 400	
	H61	3,0 m	•	€ 80,55	€ 95,85	061 86 618	
		2,7 m	•	€ 72,55	€ 86,35	061 86 615	
		1,0 m	•	€ 27,45	€ 32,65	061 86 611	
		0,9 m	•	€ 24,90	€ 29,65	061 86 610	
	H62	3,0 m	•	€ 80,55	€ 95,85	061 86 628	
		2,7 m	•	€ 72,55	€ 86,35	061 86 625	
		1,0 m	•	€ 27,45	€ 32,65	061 86 621	
		0,9 m	•	€ 24,90	€ 29,65	061 86 620	
	H63	3,0 m	•	€ 80,55	€ 95,85	061 86 638	
		2,7 m	•	€ 72,55	€ 86,35	061 86 635	
		1,0 m	•	€ 27,45	€ 32,65	061 86 631	
		0,9 m	•	€ 24,90	€ 29,65	061 86 630	
	H64	3,0 m	•	€ 80,55	€ 95,85	061 86 648	
		2,7 m	•	€ 72,55	€ 86,35	061 86 645	
		1,0 m	•	€ 27,45	€ 32,65	061 86 641	
		0,9 m	•	€ 24,90	€ 29,65	061 86 640	
	H80	3,0 m	•	€ 80,55	€ 95,85	061 86 808	
		2,7 m	•	€ 72,55	€ 86,35	061 86 805	
		1,0 m	•	€ 27,45	€ 32,65	061 86 801	
		0,9 m	•	€ 24,90	€ 29,65	061 86 800	
	H81	3,0 m	•	€ 80,55	€ 95,85	061 86 838	
		2,7 m	•	€ 72,55	€ 86,35	061 86 835	
		1,0 m	•	€ 27,45	€ 32,65	061 86 831	
		0,9 m	•	€ 24,90	€ 29,65	061 86 830	
	H95	3,0 m	•	€ 80,55	€ 95,85	061 86 958	
		2,7 m	•	€ 72,55	€ 86,35	061 86 955	
		1,0 m	•	€ 27,45	€ 32,65	061 86 951	
		0,9 m	•	€ 24,90	€ 29,65	061 86 950	



FCS®-718

FCS®-718

Artikel	Farben	Länge	Version	SB	Preis/Stück	unit price	Bestell-Nr.
article	colour	length	version	SB	exkl. MwSt.	inkl. MwSt.	order no.
786	F4	2,7 m	•	€ 83,65	€ 99,55	068 86 045	
		0,9 m	•	€ 29,25	€ 34,80	068 86 040	
	F5	2,7 m	•	€ 87,30	€ 103,90	068 86 055	
		0,9 m	•	€ 30,45	€ 36,25	068 86 050	
	F9	2,7 m	•	€ 83,65	€ 99,55	068 86 095	
		0,9 m	•	€ 29,25	€ 34,80	068 86 090	
	F6	2,7 m	•	€ 87,30	€ 103,90	068 86 065	
		0,9 m	•	€ 30,45	€ 36,25	068 86 060	
	F2	2,7 m	•	€ 87,30	€ 103,90	068 86 025	
		0,9 m	•	€ 30,45	€ 36,25	068 86 020	
	H30	2,7 m	•	€ 90,90	€ 108,15	068 86 305	
		0,9 m	•	€ 31,80	€ 37,85	068 86 300	
	H33	2,7 m	•	€ 90,90	€ 108,15	068 86 335	
		0,9 m	•	€ 31,80	€ 37,85	068 86 330	
787	F4	2,7 m	•	€ 69,45	€ 82,65	068 87 045	
		0,9 m	•	€ 24,55	€ 29,20	068 87 040	
	F5	2,7 m	•	€ 71,70	€ 85,30	068 87 055	
		0,9 m	•	€ 25,15	€ 29,95	068 87 050	
	F9	2,7 m	•	€ 69,45	€ 82,65	068 87 095	
		0,9 m	•	€ 24,55	€ 29,20	068 87 090	
	F6	2,7 m	•	€ 71,70	€ 85,30	068 87 065	
		0,9 m	•	€ 25,15	€ 29,95	068 87 060	
	F2	2,7 m	•	€ 71,70	€ 85,30	068 87 025	
		0,9 m	•	€ 25,15	€ 29,95	068 87 020	
	H30	2,7 m	•	€ 79,35	€ 94,45	068 87 305	
		0,9 m	•	€ 27,85	€ 33,15	068 87 300	
	H33	2,7 m	•	€ 79,35	€ 94,45	068 87 335	
		0,9 m	•	€ 27,85	€ 33,15	068 87 330	
788	F4	2,7 m	•	€ 72,90	€ 86,75	068 88 045	
		0,9 m	•	€ 25,75	€ 30,65	068 88 040	
	F5	2,7 m	•	€ 76,60	€ 91,15	068 88 055	
		0,9 m	•	€ 26,85	€ 31,95	068 88 050	
	F9	2,7 m	•	€ 72,90	€ 86,75	068 88 095	
		0,9 m	•	€ 25,75	€ 30,65	068 88 090	
	F6	2,7 m	•	€ 76,60	€ 91,15	068 88 065	
		0,9 m	•	€ 26,85	€ 31,95	068 88 060	
	F2	2,7 m	•	€ 76,60	€ 91,15	068 88 025	
		0,9 m	•	€ 26,85	€ 31,95	068 88 020	
	H30	2,7 m	•	€ 82,20	€ 97,80	068 88 305	
		0,9 m	•	€ 28,75	€ 34,20	068 88 300	
	H33	2,7 m	•	€ 82,20	€ 97,80	068 88 335	
		0,9 m	•	€ 28,75	€ 34,20	068 88 330	

Artikel	Farben	Länge	Version	SB	Preis/Stück	unit price	Bestell-Nr.
article	colour	length	version	SB	exkl. MwSt.	inkl. MwSt.	order no.
		1,0 m	•		€ 25,65	€ 30,50	063 86 021
		0,9 m	•		€ 23,05	€ 27,45	063 86 020
H30		3,0 m	•		€ 81,90	€ 97,45	063 86 308
		2,7 m	•		€ 73,75	€ 87,75	063 86 305
		1,0 m	•		€ 28,00	€ 33,30	063 86 301
		0,9 m	•		€ 25,30	€ 30,10	063 86 300
H33		3,0 m	•		€ 81,90	€ 97,45	063 86 338
		2,7 m	•		€ 73,75	€ 87,75	063 86 335
		1,0 m	•		€ 28,00	€ 33,30	063 86 331
		0,9 m	•		€ 25,30	€ 30,10	063 86 330
H61		3,0 m	•		€ 81,90	€ 97,45	063 86 618
		2,7 m	•		€ 73,75	€ 87,75	063 86 615
		1,0 m	•		€ 28,00	€ 33,30	063 86 611
		0,9 m	•		€ 25,30	€ 30,10	063 86 610
H62		3,0 m	•		€ 81,90	€ 97,45	063 86 628
		2,7 m	•		€ 73,75	€ 87,75	063 86 625
		1,0 m	•		€ 28,00	€ 33,30	063 86 621
		0,9 m	•		€ 25,30	€ 30,10	063 86 620
H63		3,0 m	•		€ 81,90	€ 97,45	063 86 638
		2,7 m	•		€ 73,75	€ 87,75	063 86 635
		1,0 m	•		€ 28,00	€ 33,30	063 86 631
		0,9 m	•		€ 25,30	€ 30,10	063 86 630
H64		3,0 m	•		€ 81,90	€ 97,45	063 86 648
		2,7 m	•		€ 73,75	€ 87,75	063 86 645
		1,0 m	•		€ 28,00	€ 33,30	063 86 641
		0,9 m	•		€ 25,30	€ 30,10	063 86 640
H81		3,0 m	•		€ 81,90	€ 97,45	063 86 838
		2,7 m	•		€ 73,75	€ 87,75	063 86 835
		1,0 m	•		€ 28,00	€ 33,30	063 86 831
		0,9 m	•		€ 25,30	€ 30,10	063 86 830
587 XL	F4	3,0 m	•		€ 63,45	€ 75,50	063 87 048
		2,7 m	•		€ 57,10	€ 67,95	063 87 045
		1,0 m	•		€ 22,00	€ 26,20	063 87 041
		0,9 m	•		€ 19,90	€ 23,70	063 87 040
	F9	3,0 m	•		€ 63,45	€ 75,50	063 87 098
		2,7 m	•		€ 57,10	€ 67,95	063 87 095
		1,0 m	•		€ 22,00	€ 26,20	063 87 091
		0,9 m	•		€ 19,90	€ 23,70	063 87 090
	F2	3,0 m	•		€ 65,50	€ 77,95	063 87 028
		2,7 m	•		€ 58,95	€ 70,15	063 87 025
		1,0 m	•		€ 22,60	€ 26,90	063 87 021
		0,9 m	•		€ 20,55	€ 24,45	063 87 020
	H30	3,0 m	•		€ 74,95	€ 89,20	063 87 308
		2,7 m	•		€ 67,45	€ 80,25	063 87 305
		1,0 m	•		€ 25,65	€ 30,50	063 87 301
		0,9 m	•		€ 23,05	€ 27,45	063 87 300
	H33	3,0 m	•		€ 74,95	€ 89,20	063 87 338
		2,7 m	•		€ 67,45	€ 80,25	063 87 335
		1,0 m	•		€ 25,65	€ 30,50	063 87 331
		0,9 m	•		€ 23,05	€ 27,45	063 87 330
	H61	3,0 m	•		€ 74,95	€ 89,20	063 87 618
		2,7 m	•		€ 67,45	€ 80,25	063 87 615
		1,0 m	•		€ 25,65	€ 30,50	063 87 611
		0,9 m	•		€ 23,05	€ 27,45	063 87 610
	H62	3,0 m	•		€ 74,95	€ 89,20	063 87 628
		2,7 m	•		€ 67,45	€ 80,25	063 87 625
		1,0 m	•		€ 25,65	€ 30,50	063 87 621
		0,9 m	•		€ 23,05	€ 27,45	063 87 620
	H63	3,0 m	•		€ 74,95	€ 89,20	063 87 638
		2,7 m	•		€ 67,45	€ 80,25	063 87 635
		1,0 m	•		€ 25,65	€ 30,50	063 87 631
		0,9 m	•		€ 23,05	€ 27,45	063 87 630
	H64	3,0 m	•		€ 74,95	€ 89,20	063 87 648
		2,7 m	•		€ 67,45	€ 80,25	063 87 645
		1,0 m	•		€ 25,65	€ 30,50	063 87 641
		0,9 m	•		€ 23,05	€ 27,45	063 87 640
	H81	3,0 m	•		€ 74,95	€ 89,20	063 87 838
		2,7 m	•		€ 67,45	€ 80,25	063 87 835
		1,0 m	•		€ 25,65	€ 30,50	063 87 831
		0,9 m	•		€ 23,05	€ 27,45	063 87 830
588 XL	F4	3,0 m	•		€ 65,05	€ 77,40	063 88 048
		2,7 m	•		€ 58,50	€ 69,60	063 88 045
		1,0 m	•		€ 22,45	€ 26,70	063 88 041
		0,9 m	•		€ 20,35	€ 24,20	063 88 040
	F9	3,0 m	•		€ 65,05	€ 77,40	063 88 098
		2,7 m	•		€ 58,50	€ 69,60	063 88 095

Artikel	Farben	Länge	Version	SB	Preis/Stück	unit price	Bestell-Nr.
article	colour	length	version	SB	exkl. MwSt.	inkl. MwSt.	order no.
		1,0 m	•		€ 22,45	€ 26,70	063 88 091
		0,9 m	•		€ 20,35	€ 24,20	063 88 090
F2		3,0 m	•		€ 67,05	€ 79,80	063 88 028
		2,7 m	•		€ 60,40	€ 71,90	063 88 025
		1,0 m	•		€ 23,10	€ 27,50	063 88 021
		0,9 m	•		€ 21,15	€ 25,15	063 88 020
H30		3,0 m	•		€ 74,70	€ 88,90	063 88 308
		2,7 m	•		€ 67,20	€ 79,95	063 88 305
		1,0 m	•		€ 25,50	€ 30,35	063 88 301
		0,9 m	•		€ 22,95	€ 27,30	063 88 300
H33		3,0 m	•		€ 74,70	€ 88,90	063 88 338
		2,7 m	•		€ 67,20	€ 79,95	063 88 335
		1,0 m	•		€ 25,50	€ 30,35	063 88 331
		0,9 m	•		€ 22,95	€ 27,30	063 88 330
H61		3,0 m	•		€ 74,70	€ 88,90	063 88 618
		2,7 m	•		€ 67,20	€ 79,95	063 88 615
		1,0 m	•		€ 25,50	€ 30,35	063 88 611
		0,9 m	•		€ 22,95	€ 27,30	063 88 610
H62		3,0 m	•		€ 74,70	€ 88,90	063 88 628
		2,7 m	•		€ 67,20	€ 79,95	063 88 625
		1,0 m	•		€ 25,50	€ 30,35	063 88 621
		0,9 m	•		€ 22,95	€ 27,30	063 88 620
H63		3,0 m	•		€ 74,70	€ 88,90	063 88 638
		2,7 m	•		€ 67,20	€ 79,95	063 88 635
		1,0 m	•		€ 25,50	€ 30,35	063 88 631
		0,9 m	•		€ 22,95	€ 27,30	063 88 630
H64		3,0 m	•		€ 74,70	€ 88,90	063 88 648
		2,7 m	•		€ 67,20	€ 79,95	063 88 645
		1,0 m	•		€ 25,50	€ 30,35	063 88 641
		0,9 m	•		€ 22,95	€ 27,30	063 88 640
H81		3,0 m	•		€ 74,70	€ 88,90	063 88 838
		2,7 m	•		€ 67,20	€ 79,95	063 88 835
		1,0 m	•		€ 25,50	€ 30,35	063 88 831
		0,9 m	•		€ 22,95	€ 27,30	063 88 830

Euro-Clip® Plus
Euro-Clip® Plus

568	F4	3,0 m	•		€ 65,95	€ 78,50	060 68 048
		2,7 m	•		€ 59,35	€ 70,65	060 68 045
		1,0 m	•		€ 22,75	€ 27,05	060 68 041
		0,9 m	•		€ 20,50	€ 24,40	060 68 040
	F9	3,0 m	•		€ 65,95	€ 78,50	060 68 098
		2,7 m	•		€ 59,35	€ 70,65	060 68 095
		1,0 m	•		€ 22,75	€ 27,05	060 68 091
		0,9 m	•		€ 20,50	€ 24,40	060 68 090
	F6	3,0 m	•		€ 67,50	€ 80,35	060 68 068
		2,7 m	•		€ 60,75	€ 72,30	060 68 065
		1,0 m	•		€ 23,25	€ 27,65	060 68 061
		0,9 m	•		€ 20,95	€ 24,95	060 68 060
	F2G	3,0 m	•		€ 73,35	€ 87,30	060 68 028
		2,7 m	•		€ 66,00	€ 78,55	060 68 025
		1,0 m	•		€ 25,20	€ 30,00	060 68 021
		0,9 m	•		€ 22,75	€ 27,05	060 68 020

Clip-Lifter				
Clip-Lifter 15	10 x 5 St./pcs.	€ 6,55	€ 7,80	047 515 999 9
Clip-Lifter 20	10 x 5 St./pcs.	€ 6,55	€ 7,80	047 520 999 9

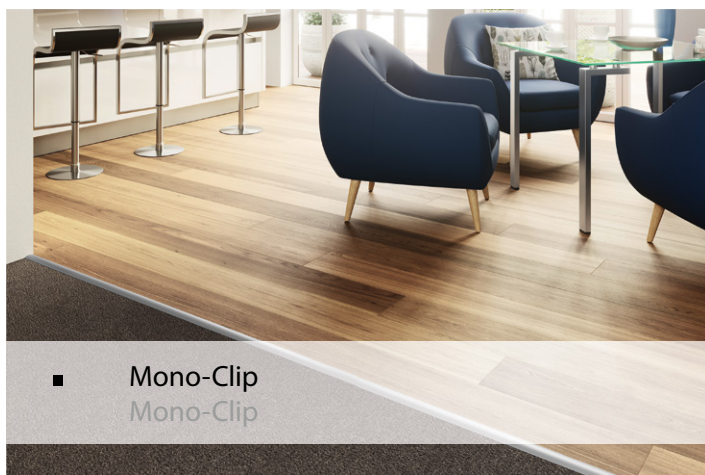

■ Mono-Clip
Mono-Clip

Artikel article	Farben colour	Länge length	Version version	SB	Preis/Stück · unit price		Bestell-Nr. order no.
					exkl. MwSt. excl. VAT	inkl. MwSt. incl. VAT	
556	F4	3,0 m	•		€ 64,35	€ 76,60	060 556 004 8
		2,0 m	•		€ 42,90	€ 51,05	060 556 004 3
		1,0 m	•		€ 22,45	€ 26,70	060 556 004 1
	F9	3,0 m	•		€ 64,35	€ 76,60	060 556 009 8
		2,0 m	•		€ 42,90	€ 51,05	060 556 009 3
	F6	1,0 m	•		€ 22,45	€ 26,70	060 556 009 1
		3,0 m	•		€ 68,85	€ 81,95	060 556 006 8
		2,0 m	•		€ 45,90	€ 54,60	060 556 006 3
	F2G	1,0 m	•		€ 23,95	€ 28,50	060 556 006 1
		3,0 m	•		€ 70,90	€ 84,35	060 556 002 8
		2,0 m	•		€ 47,25	€ 56,25	060 556 002 3
	H30	1,0 m	•		€ 24,60	€ 29,25	060 556 002 1
		3,0 m	•		€ 74,25	€ 88,35	060 556 130 8
		2,0 m	•		€ 49,50	€ 58,90	060 556 130 3
	H33	1,0 m	•		€ 25,60	€ 30,45	060 556 130 1
3,0 m		•		€ 74,25	€ 88,35	060 556 133 8	
2,0 m		•		€ 49,50	€ 58,90	060 556 133 3	
557	F4	1,0 m	•		€ 25,60	€ 30,45	060 556 133 1
		3,0 m	•		€ 59,20	€ 70,45	060 557 004 8
		2,0 m	•		€ 39,45	€ 46,95	060 557 004 3
	F9	1,0 m	•		€ 20,65	€ 24,55	060 557 004 1
		3,0 m	•		€ 59,20	€ 70,45	060 557 009 8
	F6	2,0 m	•		€ 39,45	€ 46,95	060 557 009 3
		1,0 m	•		€ 20,65	€ 24,55	060 557 009 1
		3,0 m	•		€ 62,80	€ 74,75	060 557 006 8
	F2G	2,0 m	•		€ 41,85	€ 49,80	060 557 006 3
		1,0 m	•		€ 21,85	€ 26,00	060 557 006 1
		3,0 m	•		€ 65,05	€ 77,40	060 557 002 8
	H30	2,0 m	•		€ 43,35	€ 51,60	060 557 002 3
		1,0 m	•		€ 22,60	€ 26,90	060 557 002 1
		3,0 m	•		€ 69,10	€ 82,25	060 557 130 8
	H33	1,0 m	•		€ 23,80	€ 28,30	060 557 130 1
3,0 m		•		€ 69,10	€ 82,25	060 557 133 8	
2,0 m		•		€ 46,05	€ 54,80	060 557 133 3	
558	F4	1,0 m	•		€ 23,80	€ 28,30	060 557 133 1
		3,0 m	•		€ 58,95	€ 70,15	060 558 004 8
		2,0 m	•		€ 39,30	€ 46,75	060 558 004 3
	F9	1,0 m	•		€ 20,55	€ 24,45	060 558 004 1
		3,0 m	•		€ 58,95	€ 70,15	060 558 009 8
	F6	2,0 m	•		€ 39,30	€ 46,75	060 558 009 3
		1,0 m	•		€ 20,55	€ 24,45	060 558 009 1
		3,0 m	•		€ 62,55	€ 74,45	060 558 006 8
	F2G	2,0 m	•		€ 41,70	€ 49,60	060 558 006 3
		1,0 m	•		€ 21,75	€ 25,90	060 558 006 1
		3,0 m	•		€ 64,80	€ 77,10	060 558 002 8
	H30	2,0 m	•		€ 43,20	€ 51,40	060 558 002 3
		1,0 m	•		€ 22,50	€ 26,80	060 558 002 1
		3,0 m	•		€ 68,85	€ 81,95	060 558 130 8
	H33	2,0 m	•		€ 45,90	€ 54,60	060 558 130 3
1,0 m		•		€ 23,70	€ 28,20	060 558 130 1	
3,0 m		•		€ 68,85	€ 81,95	060 558 133 8	
559	F4	2,0 m	•		€ 45,90	€ 54,60	060 558 133 3
		1,0 m	•		€ 23,70	€ 28,20	060 558 133 1
		3,0 m	•		€ 67,95	€ 80,85	060 559 004 8
	F9	2,0 m	•		€ 45,30	€ 53,90	060 559 004 3
		1,0 m	•		€ 23,65	€ 28,15	060 559 004 1
	F6	3,0 m	•		€ 67,95	€ 80,85	060 559 009 8
		2,0 m	•		€ 45,30	€ 53,90	060 559 009 3
		1,0 m	•		€ 23,65	€ 28,15	060 559 009 1

Artikel article	Farben colour	Länge length	Version version	SB	Preis/Stück · unit price		Bestell-Nr. order no.	
					exkl. MwSt. excl. VAT	inkl. MwSt. incl. VAT		
560	F6	3,0 m	•		€ 72,45	€ 86,20	060 559 006 8	
		2,0 m	•		€ 48,30	€ 57,50	060 559 006 3	
		1,0 m	•		€ 25,15	€ 29,95	060 559 006 1	
	F2G	3,0 m	•		€ 74,50	€ 88,65	060 559 002 8	
		2,0 m	•		€ 49,65	€ 59,10	060 559 002 3	
	H30	1,0 m	•		€ 25,80	€ 30,70	060 559 002 1	
		3,0 m	•		€ 77,85	€ 92,65	060 559 130 8	
		2,0 m	•		€ 51,90	€ 61,75	060 559 130 3	
	H33	1,0 m	•		€ 26,80	€ 31,90	060 559 130 1	
		3,0 m	•		€ 77,85	€ 92,65	060 559 133 8	
		2,0 m	•		€ 51,90	€ 61,75	060 559 133 3	
	561	F4	1,0 m	•		€ 26,80	€ 31,90	060 559 133 1
			3,0 m	•		€ 62,80	€ 74,75	060 560 004 8
			2,0 m	•		€ 41,85	€ 49,80	060 560 004 3
		F9	1,0 m	•		€ 21,85	€ 26,00	060 560 004 1
3,0 m			•		€ 62,80	€ 74,75	060 560 009 8	
F6		2,0 m	•		€ 41,85	€ 49,80	060 560 009 3	
		1,0 m	•		€ 21,85	€ 26,00	060 560 009 1	
		3,0 m	•		€ 66,40	€ 79,00	060 560 006 8	
F2G		2,0 m	•		€ 44,25	€ 52,65	060 560 006 3	
		1,0 m	•		€ 23,05	€ 27,45	060 560 006 1	
		3,0 m	•		€ 68,65	€ 81,70	060 560 002 8	
H30		2,0 m	•		€ 45,75	€ 54,45	060 560 002 3	
		1,0 m	•		€ 23,80	€ 28,30	060 560 002 1	
		3,0 m	•		€ 72,70	€ 86,50	060 560 130 8	
H33		2,0 m	•		€ 48,45	€ 57,65	060 560 130 3	
	1,0 m	•		€ 25,00	€ 29,75	060 560 130 1		
	3,0 m	•		€ 72,70	€ 86,50	060 560 133 8		
562	F4	2,0 m	•		€ 48,45	€ 57,65	060 560 133 3	
		1,0 m	•		€ 25,00	€ 29,75	060 560 133 1	
		3,0 m	•		€ 62,55	€ 74,45	060 561 004 8	
	F9	2,0 m	•		€ 41,70	€ 49,60	060 561 004 3	
		1,0 m	•		€ 21,75	€ 25,90	060 561 004 1	
	F6	3,0 m	•		€ 62,55	€ 74,45	060 561 009 8	
		2,0 m	•		€ 41,70	€ 49,60	060 561 009 3	
		1,0 m	•		€ 21,75	€ 25,90	060 561 009 1	
	F2G	3,0 m	•		€ 66,15	€ 78,70	060 561 006 8	
		2,0 m	•		€ 44,10	€ 52,50	060 561 006 3	
		1,0 m	•		€ 22,95	€ 27,30	060 561 006 1	
	H30	3,0 m	•		€ 68,40	€ 81,40	060 561 002 8	
		2,0 m	•		€ 45,60	€ 54,25	060 561 002 3	
		1,0 m	•		€ 23,70	€ 28,20	060 561 002 1	
	H33	3,0 m	•		€ 72,45	€ 86,20	060 561 130 8	
2,0 m		•		€ 48,30	€ 57,50	060 561 130 3		
1,0 m		•		€ 24,90	€ 29,65	060 561 130 1		
563	F4	2,0 m	•		€ 48,30	€ 57,50	060 561 133 3	
		1,0 m	•		€ 24,90	€ 29,65	060 561 133 1	
		3,0 m	•		€ 62,55	€ 74,45	060 562 004 8	
	F9	2,0 m	•		€ 41,70	€ 49,60	060 562 004 3	
		1,0 m	•		€ 21,75	€ 25,90	060 562 004 1	
	F6	3,0 m	•		€ 62,55	€ 74,45	060 562 009 8	
		2,0 m	•		€ 41,70	€ 49,60	060 562 009 3	
		1,0 m	•		€ 21,75	€ 25,90	060 562 009 1	
	F2G	3,0 m	•		€ 66,15	€ 78,70	060 562 006 8	
		2,0 m	•		€ 44,10	€ 52,50	060 562 006 3	
		1,0 m	•		€ 22,95	€ 27,30	060 562 006 1	
	H30	3,0 m	•		€ 72,45	€ 86,20	060 562 002 8	
		2,0 m	•		€ 48,30	€ 57,50	060 562 002 3	
		1,0 m	•		€ 24,90	€ 29,65	060 562 002 1	
	564	F4	2,0 m	•		€ 48,30	€ 57,50	060 562 002 3
1,0 m			•		€ 24,90	€ 29,65	060 562 002 1	
3,0 m			•		€ 66,40	€ 79,00	060 563 004 8	
F9		2,0 m	•		€ 41,85	€ 49,80	060 563 004 3	
		1,0 m	•		€ 23,05	€ 27,45	060 563 004 1	
F6		3,0 m	•		€ 66,40	€ 79,00	060 563 009 8	
		2,0 m	•		€ 44,25	€ 52,65	060 563 009 3	
		1,0 m	•		€ 23,05	€ 27,45	060 563 009 1	
F2G		3,0 m	•		€ 70,00	€ 83,30	060 563 006 8	
		2,0 m	•		€ 46,65	€ 55,50	060 563 006 3	
		1,0 m	•		€ 24,25	€ 28,85	060 563 006 1	
H30		3,0 m	•		€ 72,25	€ 86,00	060 563 002 8	
		2,0 m	•		€ 48,15	€ 57,30	060 563 002 3	
		1,0 m	•		€ 25,00	€ 29,75	060 563 002 1	
565		F4	3,0 m	•		€ 66,15	€ 78,70	060 564 004 8
	2,0 m		•		€ 44,10	€ 52,50	060 564 004 3	
	1,0 m		•		€ 22,95	€ 27,30	060 564 004 1	
	F9	3,0 m	•		€ 66,15	€ 78,70	060 564 009 8	
		2,0 m	•		€ 44,10	€ 52,50	060 564 009 3	
	F6	1,0 m	•		€ 22,95	€ 27,30	060 564 009 1	
		3,0 m	•		€ 69,75	€ 83,00	060 564 006 8	
		2,0 m	•		€ 46,50	€ 55,35	060 564 006 3	
	F2G	1,0 m	•		€ 24,15	€ 28,75	060 564 006 1	
		3,0 m	•		€ 72,00	€ 85,70	060 564 002 8	
		2,0 m	•		€ 48,00	€ 57,10	060 564 002 3	
	H30	1,0 m	•		€ 24,90	€ 29,65	060 564 002 1	

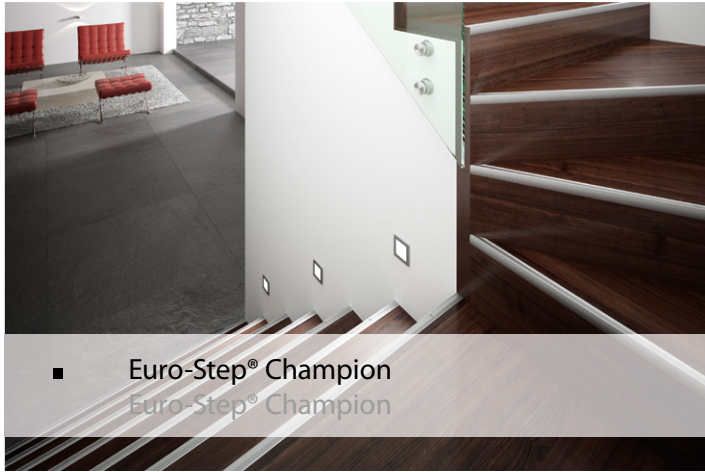

■ Euro-Step® Champion
Euro-Step® Champion

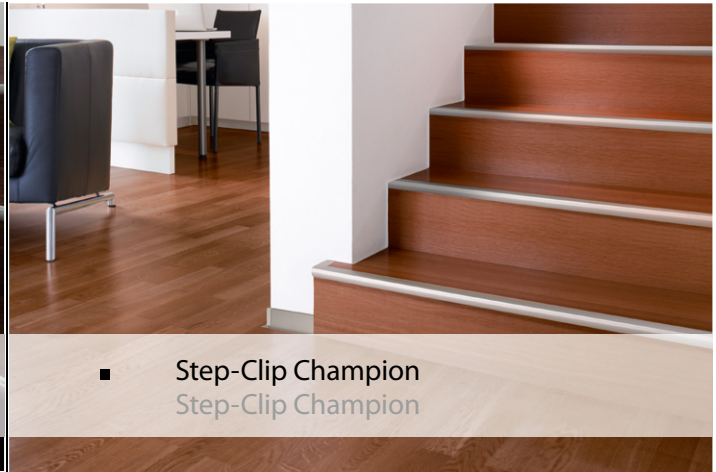

■ Step-Clip Champion
Step-Clip Champion

Artikel article	Farben colour	Länge length	Version SB version SB	Preis/Stück exkl. MwSt. excl. VAT	unit price inkl. MwSt. incl. VAT	Bestell-Nr. order no.
320	F4	3,0 m	•	€ 117,45	€ 139,75	074 20 048
		2,7 m	•	€ 105,70	€ 125,80	074 20 045
		1,0 m	•	€ 39,70	€ 47,25	074 20 041
F5	F5	3,0 m	•	€ 121,75	€ 144,90	074 20 058
		2,7 m	•	€ 109,60	€ 130,40	074 20 055
		1,0 m	•	€ 41,20	€ 49,05	074 20 051
F9	F9	3,0 m	•	€ 117,45	€ 139,75	074 20 098
		2,7 m	•	€ 105,70	€ 125,80	074 20 095
		1,0 m	•	€ 39,70	€ 47,25	074 20 091
F6	F6	3,0 m	•	€ 121,75	€ 144,90	074 20 068
		2,7 m	•	€ 109,60	€ 130,40	074 20 065
		1,0 m	•	€ 41,20	€ 49,05	074 20 061
F2	F2	3,0 m	•	€ 121,75	€ 144,90	074 20 028
		2,7 m	•	€ 109,60	€ 130,40	074 20 025
		1,0 m	•	€ 41,20	€ 49,05	074 20 021

Artikel article	Farben colour	VE VE	Version SB version SB	Preis/Stück exkl. MwSt. excl. VAT	unit price inkl. MwSt. incl. VAT	Bestell-Nr. order no.
510	F4	3,0 m	•	€ 129,60	€ 154,20	070 10 048
		1,0 m	•	€ 43,60	€ 51,90	070 10 041
F9	F9	3,0 m	•	€ 129,60	€ 154,20	070 10 098
		1,0 m	•	€ 43,60	€ 51,90	070 10 091
F2 G	F2 G	3,0 m	•	€ 148,95	€ 177,25	070 10 028
		1,0 m	•	€ 50,05	€ 59,55	070 10 021
H30	H30	3,0 m	•	€ 149,20	€ 177,55	070 10 308
		1,0 m	•	€ 50,10	€ 59,60	070 10 301
H33	H33	3,0 m	•	€ 149,20	€ 177,55	070 10 338
		1,0 m	•	€ 50,10	€ 59,60	070 10 331

Schräg- und Blendwinkel – Euro-Step® Champion und Step-Clip
Sloping and Facing edges – Euro-Step® Champion and Step-Clip

402	F0	3,0 m	•	€ 77,40	€ 92,10	073 02 008
		2,7 m	•	€ 69,70	€ 82,95	073 02 005
		1,0 m	•	€ 26,55	€ 31,60	073 02 001
401	F4	0,9 m	•	€ 21,60	€ 25,70	073 02 000
		3,0 m	•	€ 27,25	€ 32,45	173 01 048
		3,0 m	•	€ 29,70	€ 35,35	173 01 058
F9	F9	3,0 m	•	€ 27,25	€ 32,45	173 01 098
		3,0 m	•	€ 29,70	€ 35,35	173 01 068
F2	F2	3,0 m	•	€ 29,70	€ 35,35	173 01 028
		3,0 m	•	€ 38,50	€ 45,80	173 01 308
H30	H30	1,0 m	•	€ 13,05	€ 15,55	173 01 301
		3,0 m	•	€ 38,50	€ 45,80	173 01 338
H33	H33	1,0 m	•	€ 13,05	€ 15,55	173 01 331

■ Euro-Step® Star
Euro-Step® Star

325	F4	3,0 m	•	€ 99,45	€ 118,35	074 25 048
		2,7 m	•	€ 89,50	€ 106,50	074 25 045
		1,0 m	•	€ 33,90	€ 40,35	074 25 041
F5	F5	3,0 m	•	€ 104,40	€ 124,25	074 25 058
		2,7 m	•	€ 94,00	€ 111,85	074 25 055
		1,0 m	•	€ 35,40	€ 42,15	074 25 051
F9	F9	3,0 m	•	€ 99,45	€ 118,35	074 25 098
		2,7 m	•	€ 89,50	€ 106,50	074 25 095
		1,0 m	•	€ 33,90	€ 40,35	074 25 091
F6	F6	3,0 m	•	€ 104,40	€ 124,25	074 25 068
		2,7 m	•	€ 94,00	€ 111,85	074 25 065
		1,0 m	•	€ 35,40	€ 42,15	074 25 061
F2	F2	3,0 m	•	€ 104,40	€ 124,25	074 25 028
		2,7 m	•	€ 94,00	€ 111,85	074 25 025
		1,0 m	•	€ 35,40	€ 42,15	074 25 021







■ **Kontaktformular**

per Fax an: **02351 9507 - 49**

Bitte senden Sie uns folgendes Informationsmaterial zu: Menge

- Katalog **Küberit »Das Profil-Buch«** _____
- Prospekt **Deco Base-Board / Aluminium Sockelleisten** _____
- Prospekt **EB-Profile** _____
- Prospekt **PPS®-Champion Star** _____
- Prospekt **Design-Clip® / Design-Clip® XL** _____
- Prospekt **PPS®-Champion flex** _____
- Prospekt **PPS®-Champion + SK /**
PPS®-Champion XXL / XXL S _____
- Prospekt **PPS®-Allrounder** _____
- Prospekt **PPS®-Magic** _____
- Prospekt **FCS®-718** _____
- Prospekt **Euro-Clip®** _____
- Prospekt **Mono-Clip** _____
- Prospekt **Euro-Step® Champion / Star** _____
- Prospekt **Step-Clip Champion** _____
- Prospekt **Eckschutz- und Wandprofile** _____
- Wandkarte **Profillösungen für LVT-Designbeläge** _____
- Wir bitten um telefonische Kontaktaufnahme
unter folgender Rufnummer: _____
- Ansprechpartner: _____
- Wir bitten um Zusendung folgender Muster:

■ Contact Form

Fax no.: **+49 2351 9507 - 200**

Please send us the following information / literature: Quantity

- Catalogue **Küberit»Das Profil-Buch«** _____
- Brochure **Deco Base-Board / Aluminium Baseboards** _____
- Brochure **EB-Profile** _____
- Brochure **PPS®-Champion Star** _____
- Brochure **Design-Clip® / Design-Clip® XL** _____
- Brochure **PPS®-Champion flex** _____
- Brochure **PPS®-Champion + SK /**
PPS®-Champion XXL / XXL S _____
- Prospekt **PPS®-Allrounder** _____
- Brochure **PPS®-Magic** _____
- Brochure **FCS®-718** _____
- Brochure **Euro-Clip®** _____
- Brochure **Mono-Clip** _____
- Brochure **Euro-Step® Champion / Star** _____
- Brochure **Step-Clip Champion** _____
- Brochure **Corner Guards and Wall Profiles** _____
- Wall Card **Profile Solution for LVT Flooring** _____
- Please contact us directly

under phone number: _____

Contact person: _____

- Please send us the following samples:

Suchhilfe / Search assistance

TYP TYPE	INFO/SEITE INFO/PAGE	PREIS/SEITE PRICE/PAGE
010	27	182
011	27	182
012	27	182
015	27	182
142	90	198
143	90	199
150	92	199
155	92	199
160	92	199
167	14	177
170	92	199
172	90	199
174	90	199
192	30	183
196	30	183
200 U	31	183
201 U	31	183
202 U	31	183
203 U	31	183
204 U	31	183
206	49	190
207	49	190
208	49	190
209	49	190
210	28	182
210 EB	79	197
211	28	182
212	28	182
212 EB	79	197
213	29	183
213 EB	79	197
214	29	183
215	29	183
217	30	183
219	30	183
221	31	184
222	31	184
223	25	181
225	40	186
226	39	186
227	39	186
228	40	187
229	40	187
230	11	173
231	12	175
234 SK	38	186
235	38	185
236	38	184
237	38	186
238 N/SK	24	181
238 U	42	187
240	18	177
241	18	178
243	19	178
244	18	177
245	18	178
247	19	178
248	19	179
250	18	177
256	124	203
257	124	203
258	124	203
260	32	184
261 U	34	184
261 EC	35	184
262 U	34	184
262 EC	34	184
263 U	35	184
263 EC	35	184
264	32	184
265	32	184
266 U	35	184
266 EC	35	184
267 U	35	184
267 EC	35	184
268	32	184
269 U	32	184
269 EC	33	184
270 N U	33	184
270 N EC	33	184
271	88	198
272 U	88	198
273	88	198
274 U	88	198
275	88	198
276 U	88	198
277 U	42	187
278 U	42	187
279 U	42	187
283	88	198
286	123	203
286 SK	125	203
287 N	117	202
287	123	203
287 N/SK	125	203
288	123	203
288 SK	125	203
290	83	197
291	83	198
292	24	181
292 R	24	181
293	84	198
294	25	181
295	83	198
297	25	181

TYP TYPE	INFO/SEITE INFO/PAGE	PREIS/SEITE PRICE/PAGE
297 R	25	181
297 EB	78	197
299	71,91	194,199
300	71	195
300 S	71	195
301	71	195
301 S	71	195
302	71	195
302 S	71	195
303	72	195
303 S	73	195
304	73	196
304 S	73	196
305	73	196
305 S	73	196
306	74	196
306 S	74	196
307	72	195
307 S	72	195
308	73	196
309	74	196
311	73	196
312	74	196
313	74	196
316	76	197
317	76	197
318	76	197
319 G	76	197
320	160	210
323 G	76	197
324 G	76	197
325	163	210
330	32	184
332	32	184
335 G	74	196
336 G	75	197
338 G	74	196
341	22	181
342	22	181
345	26	181
345 EB	78	197
346	26	181
355	21,91	180,199
356	21	180
356 EB	77	197
357	21	180
357 EB	77	197
358	21	180
359	21	180
359 EB	77	197
361 /3	22	180
361 /3,5	22	180
361 /3 EB	77	197
362	22	181
363	23	181
363 EB	78	197
364	22	181
365	23,91	181,199
365 EB	78	197
366	23	181
366 EB	78	197
367	23	181
368	23	181
368 EB	78	197
369 SK	23	181
369 N/SK	24	181
370	20	179
371	20	180
371 EB	78	197
376	105	200
377	105	201
378	105	201
380	20	179
382	20	180
383	21	180
386 XXL	128	204
386 XXL S	129	204
386 AS	137	205
387 XXL	128	204
387 XXL S	129	204
387 AS	137	205
388 XXL	128	204
388 XXL S	129	204
388 AS	137	205
390	20	179
401 U	42	187
401	161	210
402	161	210
438	11	174
439	11	173
440	11	174
441	9	171
442	8	170
444	9	172
445	11	174
445 /3	13	175
451	13	175
452	13	176
453	13	176
454	14	176
455	14	176
456	14	176
457	14	176
458	8	170
459	8	170

TYP TYPE	INFO/SEITE INFO/PAGE	PREIS/SEITE PRICE/PAGE
460	8	171
461	8	171
462	9	171
463	9	172
464	9	172
465	10	173
466	10	173
470 S	12	175
471	13	175
472	13	175
473	13	176
474	14	176
475	14	176
486	133	204
487	133	205
488	133	205
510	166	210
526	38	186
530	41	187
535	41	187
540	41	187
542 U	89	198
543 U	89	198
544 U	42	187
545 U	42	187
550	140	206
551	140	206
552	140	206
556	156	209
557	156	209
558	156	209
559	157	209
560	157	209
561	157	209
562	157	209
563	157	209
564	157	209
568	152	208
576	111	201
576 XL	113	202
577	111	201
577 XL	113	202
578	111	201
578 XL	113	202
586 L	151	206
586 XL	152	207
587 L	151	207
587 XL	152	208
588 L	151	207
588 XL	152	208
700	45	188
701	45	188
702	45	188
703	46	188
704	46	188
705	46	188
706	44	188
707	44	188
708 N	44	188
709	46	188
711	46	188
712	46	189
713	47	189
715	47	189
730	66	193
731	66	193
732	66	193
733	66	193
734	67	194
735	67	194
736	67	194
737	67	194
738	67	194
739	67	194
786	145	206
787	145	206
788	145	206
801	26	181
801 EB	78	197
802	26	181
802 EB	79	197
803	26	181
803 EB	79	197
804	26	181
804 EB	79	197
805	27	182
805 EB	79	197
806	27	182
806 EB	79	197
807	48	189
807 EB	80	197
808	48	189
808 EB	80	197
809	48	189
809 EB	80	197
810	48	189
810 EB	80	197
811	48	190
811 EB	80	197
812	48	190
812 EB	80	197
813	48	190
813 EB	80	197
826	49	190
828	49	190

TYP TYPE	INFO/SEITE INFO/PAGE	PREIS/SEITE PRICE/PAGE
830	49	190
832	50	190
835	50	190
838	50	190
844	52	191
844 WS	52	191
845	52	191
845 AE	52	191
845 ER	52	191
845 EL	52	191
845 EC	61	192
846	52	191
846 EC	61	192
847	52	191
847 AE	52	191
847 ER	52	191
847 EL	52	191
850	50	191
852	50	191
852 EB	81	197
855	50	190
857	51	191
859	54	191
859 EC	58	192
859 EB	81	197
860	54	191
860 EC	58	192
860 EB	81	197
861	54	191
861 EB	81	197
862	54	191
862 EC	59	192
862 EB	81	197
863	55	191
863 EB	81	197
864	55	191
864 EB	81	197
865	55	191
866	55	192
870	56	192
870 IW	57	192
870 EC/EV	60	192
870 EB	82	197
871	56	192
871 IW	57	192
871 EC/EV	60	192
871 EB	82	197
872	56	192
872 EB	82	197
873	56	192
873 EB	82	197
874	56	192
874 EB	82	197
875	56	192
877 IW	57	192
886	117	202
888	117	202
890	62	193
891	62	193
893	63	193
894	63	193
895 V	63	193
895 L	63	193
896	63	193
897	63	193
898	63	193
899	63	193
901	100	199
910	100	199
911	100	199
912	100	199
913	100	199
916 U	100	199
917 U	100	199
917 AE	101	199
917 IE	101	199
927 U	99	199
931	99	200
931 D	99	200
934	98	199
934 D	98	199
935	98	199
936	98	199
938	97	199
945 U	99	199
950	98	199
950 D	98	199
RW 20	41	187
RW 38	41	187
RW 5	41	187
2504	45	189
2505	45	189
2510	47	189
2511	47	189
2512	47	189
Biegemaschine	84	198
Clip-Lifter	150	208
Formteile	99	200
PPS-Kreuze	124, 129, 132, 137	203, 204, 205,
PPS-Lifter	105, 117, 123, 128, 133, 136, 141,	203
T-Dübel	84	

Die Küberit-Materialien / Küberit Materials

Aluminium eloxiert / Aluminium anodized

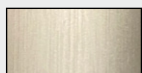

F1G
platinum fein geschliffen
platinum brushed



F2
edelstahloptik
stainless steel optic



F2G
edelstahloptik fein geschliffen
stainless steel optic brushed



F4G
silber fein geschliffen
silver brushed



F4
silber
silver



F5
gold
gold

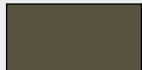

F6
bronze
bronze



F9
sand
sand

Aluminum / Aluminium

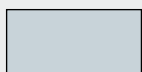

F0
natur
nature



F3
poliert
polished



F7
Messing poliert
brass polished

Edelstahl / stainless steel



F8
Edelstahl poliert
stainless steel polished

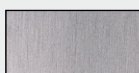

F8G
Edelstahl matt gebürst
stainless steel brushed

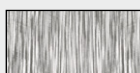

F8C
Edelstahl Crossline
stainless steel Crossline

Gleitschutzeinlagen / Anti Slip Inserts



GE1
schwarz
black

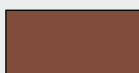

GE3
braun
brown

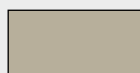

GE5
beige
beige

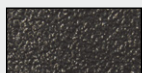

GM7
Mineral schwarz
mineral black



GM8
Mineral gelb
mineral yellow

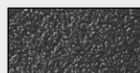

GM9
Mineral grau
mineral grey

Gleitschutzeinlage PVC / Anti Slip Inserts PVC



GS1
schwarz
black



GS2
silber
silver

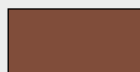

GS3
braun
brown

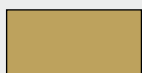

GS4
messing
brass



GS5
beige
beige

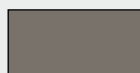

GS6
grau
grey

PVC Einlagen / PVC Inserts



F100
schwarz
black



F130
braun
brown

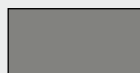

F140
anthrazit
anthracite

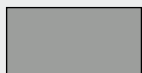

F142
hellgrau
light grey



F143
beigegrau
beige-grey

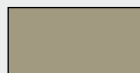

F149
beige
beige



F169
blau
blue



F189
rot
red



F200
nachleuchtend
fluorescent



F190
gelb
yellow

Holzdekor / Wood Decor



H20
Buche dunkel
beech dark

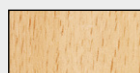

H22
Buche hell
beech light

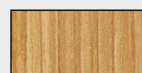

H30
Eiche hell
oak light



H31
Eiche dunkel
oak dark

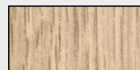

H33
Eiche weiß gekalkt
white washed oak

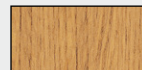

H34
Landeiche
country oak



H40
Ahorn
maple

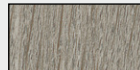

H61
Eiche grau
oak grey

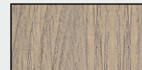

H62
Eiche beige-grau
oak beige-grey

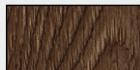

H63
Tigua
Tigua



H64
Eiche creme
oak creme



H65
Eiche hellgrau
oak light grey

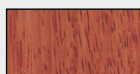

H80
Merbau
merbau

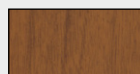

H81
Nussbaum
walnut

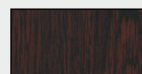

H95
Wenge
wenge



Sonderfarben / Special colours



F16*
RAL 9005
schwarz matt
black matt



F15*
RAL 9016
weiß hochglanz
white high-gloss



F18*
RAL 7016
anthrazit grau
anthracit grey

* Sie können unsere RAL-Farben auf Nachfrage in drei Glanzgraden erhalten (**matt, semimatt und in hochglanz**). Unter Berücksichtigung von Mindestabnahmemengen können alle Aluminiumprofile auch mit Pulverbeschichtung geliefert werden!

Our RAL-colours are available on request in three gloss variations (**matt, semimatt and in high-gloss**). On request all aluminium profiles can be delivered with powder-coating! Minimum quantities requested.

Details zu Längen, Versionen und Material entnehmen Sie bitte der Preisliste ab Seite 170!

Please have a look at our pricelist (page 170 ff) to find detailed information about lengths, versions and material!

Wichtige Hinweise / Important Informations

Eine immer gleichbleibende Eloxal-Farbe kann aus chemisch-technischen Gründen nicht garantiert werden. Alle angegebenen Abmessungen sind ca. Angaben und beinhalten zudem Maßtoleranzen gem. DIN EN 12020-2. Durch Ablagerungen von Schmutz und Fett können Messing-Profile mit der Zeit anlaufen.

Due to chemical-technical reasons we cannot guarantee constant colours for anodized products. All given dimensions are approximate and include dimensional tolerances in accordance with DIN EN 12020-2. Dirt and grease deposits can cause brass profiles to tarnish over time.

Technische Änderungen sowie Abweichungen in Maserung und Farbe vorbehalten. Irrtümer, Druckfehler und Preisänderungen vorbehalten!

Subject to technical changes and deviations in grain and colour. Subject to errata, printing errors and price changes!

Sous réserves de modifications de structure et de couleur. Sous réserve d'erreurs, de fautes d'impression et de modifications de prix!





ORIGINAL **Küberit**®
since 1863

Küberit Profile Systems GmbH & Co. KG
Römerweg 9 • 58513 Lüdenscheid • Germany

Tel.: +49 2351 9507 0

Fax: +49 2351 9507 49

Fax Export: +49 2351 9507 200

www.kueberit.com

kueberit@kueberit.com • export@kueberit.com



kueberit.com



ORIGINAL *Küberit*®
since 1863

Küberit Profile Systems GmbH & Co. KG
Römerweg 9 • 58513 Lüdenscheid • Germany

Tel.: +49 2351 9507 0
Fax: +49 2351 9507 49
Fax Export: +49 2351 9507 200

www.kueberit.com
kueberit@kueberit.com • export@kueberit.com

Ihr Küberit-Fachhändler / Your Küberit dealer

ePaper



kueberit.com/qr/pbuch